

SMART MANUFACTURING



YAGEO

PRODUCT SELECTION GUIDE 2020

TELECOMMUNICATION



5G

POWER & ENERGY



AUTOMOTIVE



CHIP RESISTORS
SURFACE MOUNT MLCC
WIRELESS COMPONENTS
www.yageo.com

Part numbering system and ordering

You can order components from this catalogue in two ways. Both ways give logistic and packing information.

- **Clear text ordering code**

This unique number is an easily-readable code.

- 17 digits code (GLOBAL PART NUMBER for both Yageo and Phycomp branded products)

You will find details for ordering in the "*Ordering*" section next to each selection chart.

Minimum shipment quantities, prices and delivering details can be obtained from the Yageo sales organization in your country or from one of our franchised distributors.

Case size codes

Throughout this catalogue, inch-based codes are used for the component sizes. According to IEC 60384-10, amendment 2 of September 2000 for MLCCs, and IEC 60115-8, amendment 1 of July 2000 for R-chip. Values for length and width should be in millimeters rather than in inches. To distinguish between inch-based codes and metric-based codes, metric-based codes will temporarily have the suffix "M". The table right next shows the relation between inch-based case sizes versus the recommended metric case size designators. Please note that HF products use metric case size only.

Case size designation and cross-reference					
Inch-based	Metric	Inch-based	Metric	Inch-based	Metric
0050	0201M	0612	1632M	1812	4532M
0075	03015M	0616	1640M	2007	5320M
01005	0402M	0805	2012M	2010	5025M
0201	0603M	0815	2037M	2220	5750M
0202	0605M	0830	2075M	2512	6432M
0402	1005M	1008	2520M	3014	7836M
0404	1010M	1206	3216M	4527	11070M
0408	1020M	1210	3225M	3921	10052M
0508	1220M	1218	3245M	5931	15078M
0603	1608M	1224	3250M		
0606	1616M	1225	3264M		

Contact us

Founded in 1977, the Yageo Corporation has become a world-class provider of passive-component services with capabilities on a global scale, including production and sales facilities in Asia, Europe and America. The corporation is uniquely positioned to provide one-stop-shopping, offering its complete product portfolio of resistors, capacitors and inductors in both commodity and specialty versions, plus design-in capability, distribution, e-commerce connection and logistics. Yageo markets its products under the product brand names Yageo, Phycomp and Vitrohm. All products can be obtained from our Yageo sales offices, of which contact details can be found on the backcover of this catalogue. For most up-to-date information, as well as contact details of our franchise distributors, please refer to our website: www.yageo.com

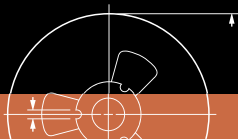

Table of Contents

Chip Resistors General Information		
	Specification overview	7
	Ordering information - Global part number	15
	Ordering information - North America	17
	IEC publication 63, SPQ, last digit of 12NC	18
Chip Resistors Selection Charts		
	RC - Thick film general purpose chip resistors, 0075 to 2512	19
	RC_P - Total lead free thick film general purpose chip resistor, 0201 to 2512	24
	RE - Thick film precision grade chip resistors, 0201 to 1206	27
	YC/TC - Thick film array / network chip resistors	29
	YC/TC - Arrays, convex / concave / flat	31
	YC/TC - Network, T-type / L-type	32
	AC - Automotive grade chip resistors, 0201 to 2512	33
	AC - Automotive grade sulfur-resistant chip resistors, wide termination, 0612 to 1225	36
	AC - Automotive grade chip resistors, TCR 50ppm, 0402 to 1206	38
	AF - Sulfur resistant chip resistors, 0201 to 2512	40
	AF - Sulfur resistant chip resistors, Arrays	43
	AA - Automotive grade sulfur-resistant chip resistors, 0201 to 2512	46
	SR - Surge chip resistors, 0402 to 2512	49
	RV - High voltage chip resistors, 0603 to 2512	52
	CP - Cooper termination chip resistor, 0201	55
	RT - Thin film high precision high stability chip resistors, 0201 to 2512	57
	AT - Automotive grade Thin film high precision high stability chip resistors	61
	RL - Thick film low ohmic chip resistors, 0402 to 2512	63
	RL - Thick film low ohmic, high power chip resistors, 0805 / 1206	66
	PT - Thick film low ohmic low T. C. R. chip resistors, 0402 to 2512	67
	PA - Current sensors - low T. C. R. chip resistors, 0201 to 2512	70
	PA - Low profile current sensors - low T. C. R. chip resistors, 1206 to 2010	73
	PE - Current sensors - low T. C. R. chip resistors, 01005 to 2512	75
	PE - Current sensors - low T. C. R. chip resistors, wide termination, 0508 to 0815	78
	PS - Current sensors - low T. C. R. chip resistors, 4 termination, 0306 / 0612 / 1206	80
	PU - Shunt chip resistors, 2512 / 3921 / 5931	83
	PU - Shunt chip resistors, 6820	86
	PU - Shunt chip resistors, 8420 / 8518	88
	PU - Shunt chip resistors, 8420_E	90
	PU - Shunt chip resistors, 8420_N	92
	AR - NiAu termination chip resistors, 0402 to 1206	94
	TR - Trimmable chip resistors, 0402 to 1206	96
	ATV - RF attenuator chip resistors, 0404	98
	Sample Kits / Sample Books	101
MLCC General Information		
	Specification overview	103
	Ordering information - Global part number	104
	Thickness classes and packing quantities for all series	106



MLCC Selection Charts		
	NPO - General purpose	107
	NPO - General purpose 10 to 50V, 01005 to 1812	107
	NPO - Medium & High voltage	111
	NPO - Medium voltage, 0201 to 1812	112
	NPO - High voltage, 0805 to 1812	114
	NPO - High frequency	115
	NPO - High frequency, 01005 to 0805	115
	X7R - General purpose & High capacitance	117
	X7R - General purpose & High capacitance, 01005 to 2220	117
	X7R - Medium voltage & High voltage	121
	X7R - Medium voltage & High voltage, 0402 to 1812	121
	X7R / X5R - Low inductance	124
	X7R / X5R - Low inductance, 0204 to 0612	124
	NPO / X7R - Soft termination	125
	NPO - Soft termination, 0402 to 1812	126
	X7R - Soft termination, 0402 to 1812	129
	X5R / Y5V - General purpose & High capacitance	134
	X5R - General purpose & High capacitance, 01005 to 1210	134
	Y5V - General purpose & High capacitance 6.3 to 50V, 0402 to 1210	139
	Automotive grade MLCCs	141
	NPO / X8G / X7R / X8R - Automotive grade / High frequency, 0201 to 1812	141
	NPO / X7R - Automotive grade 4-C Arrays, 0508 / 0612	147
	X7R - Automotive grade with Soft termination, 0805 to 1210	148
	Arrays	150
	NPO / X7R - 4C Arrays, 0508 / 0612	150
	Sample Books	152
X2Y [®] Product Selection Charts		
	SMD ceramic EMI filter capacitors X2Y [®] series & Ordering information	154
Wireless Components Selection Charts		
	Introduction	158
	Antenna - 2.4 GHz	160
	Antenna - 2.4 GHz, 2.4 GHz / GPS, 2.4 / 5 GHz	161
	Antenna - 5 GHz, Cellular WWAN, Short Range	162
	Antenna - Short-Range, GPS	163
	Antenna - GPS	164
	Antenna - GPS, GPS+Glonass, GNSS	165
	Antenna - GNSS, GPS L1+L5, GNSS+L2&L5, Active GPS / GPS+Glonass / L1+L5	166
	Antenna - Active L1+L2, FM, SDARS, Filter (BPF)	167
	Filter (BPF) / (LPF)	168
	Filter (LPF) / (Diplexer)	169
	Filter (Diplexer)	170
	Filter (Triplexer), Balun	171
	Balun, Balance Filter (Combo), Coupler	172
	Ordering Information	173
	Sample Books	174



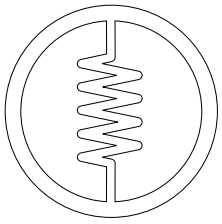

SURFACE MOUNT CHIP RESISTORS

Chip Resistors General Information

Specification overview

Global part number	Series	Size	Power rating	Max. voltage	Operating Temp. range	Resistance range	Tolerance	T. C. R.					
RC0075xR-07xxxxL	RC	0075	1/50W	10V	-55°C to 125°C	10Ω ≤ R ≤ 1MΩ Jumper < 50mΩ	±1% ±5%	10Ω ≤ R < 100Ω -200/+600 ppm/°C 100Ω ≤ R ≤ 1MΩ ±200 ppm/°C					
RC0100xR-07xxxxL		01005	1/32W	15V		1Ω ≤ R ≤ 22MΩ Jumper < 50mΩ	Max./Min.:10MΩ/1Ω ±1% Max.: 22MΩ ±5% Max./Min.:470KΩ/33Ω ±0.5%	1Ω ≤ R < 10Ω -200/+600 ppm/°C 10Ω ≤ R < 100Ω ±300 ppm/°C 100Ω ≤ R ≤ 10MΩ ±200 ppm/°C 10MΩ < R ≤ 22MΩ ±250 ppm/°C					
RC0201xR-07xxxxL		0201	1/20W	25V		1Ω ≤ R ≤ 10MΩ Jumper < 50mΩ	Max./Min.:1MΩ/10Ω ±0.1,0.5% Max.: 10MΩ ±1%,±5%	1Ω ≤ R ≤ 10Ω -100/+350 ppm/°C 10Ω < R ≤ 10MΩ ±200 ppm/°C					
RC0402xR-07xxxxL		0402	1/16W	50V	-55°C to 155°C	1Ω ≤ R ≤ 22MΩ Jumper < 50mΩ	Max./Min.:1MΩ/10Ω ±0.1%,±0.5% Max.:10MΩ ±1% Max.:22MΩ ±5%	1Ω ≤ R ≤ 10Ω ±200 ppm/°C 10Ω < R ≤ 10MΩ ±100 ppm/°C 10MΩ < R ≤ 22MΩ ±200 ppm/°C					
RC0603xR-07xxxxL		0603	1/10W	75V									
RC0805xR-07xxxxL		0805	1/8W	150V					1Ω ≤ R ≤ 100MΩ Jumper < 50mΩ	Max./Min.:1MΩ/10Ω ±0.1%,±0.5% Max.:10MΩ ±1% Max.:100MΩ ±5% Max./Min.:100MΩ/24MΩ ±10%,±20%	1Ω ≤ R ≤ 10Ω ±200 ppm/°C 10Ω < R ≤ 10MΩ ±100 ppm/°C 10MΩ < R ≤ 22MΩ ±200 ppm/°C 24MΩ ≤ R ≤ 100MΩ ±300 ppm/°C		
RC1206xR-07xxxxL		1206	1/4W	200V		1Ω ≤ R ≤ 100MΩ Jumper < 50mΩ	Max./Min.:1MΩ/10Ω ±0.1%,±0.5% Max.:10MΩ ±1% Max.:100MΩ ±5% Max./Min.:100MΩ/24MΩ ±10%,±20%	1Ω ≤ R ≤ 10Ω ±200 ppm/°C 10Ω < R ≤ 10MΩ ±100 ppm/°C 10MΩ < R ≤ 22MΩ ±200 ppm/°C 24MΩ ≤ R ≤ 100MΩ ±300 ppm/°C					
RC1210xR-07xxxxL		1210	1/2W	200V		1Ω ≤ R ≤ 22MΩ Jumper < 50mΩ	Max./Min.:1MΩ/10Ω ±0.1%,±0.5% Max.: 10MΩ ±1% Max.:22MΩ ±5%	1Ω ≤ R ≤ 10Ω ±200 ppm/°C 10Ω < R ≤ 10MΩ ±100 ppm/°C 10MΩ < R ≤ 22MΩ ±200 ppm/°C					
RC1218xK-07xxxxL		1218	1W	200V		1Ω ≤ R ≤ 1MΩ Jumper < 50mΩ	Max./Min.:1MΩ/10Ω ±0.1%,±0.5% Max.:1MΩ ±1%,±5%	1Ω ≤ R ≤ 10Ω ±200 ppm/°C 10Ω < R ≤ 1MΩ ±100 ppm/°C					
RC2010xK-07xxxxL		2010	3/4W	200V		1Ω ≤ R ≤ 22MΩ Jumper < 50mΩ	Max./Min.:1MΩ/10Ω ±0.1%,±0.5% Max.: 10MΩ ±1% Max.:22MΩ ±5%	1Ω ≤ R ≤ 10Ω ±200 ppm/°C 10Ω < R ≤ 10MΩ ±100 ppm/°C 10MΩ < R ≤ 22MΩ ±200 ppm/°C					
RC2512xK-07xxxxL		2512	1W	200V									
RC0402xR-7WxxxxL		0402	1/8W	50V		-55°C to 155°C	1Ω ≤ R ≤ 1MΩ	±1% ±5%	±200 ppm/°C				
RC0603xR-7WxxxxL		0603	1/5W	75V									
RC0805xR-7WxxxxL		0805	1/4W	150V									
RC1206xR-7WxxxxL		1206	1/2W	200V									
RC2512xK-7WxxxxL		2512	2W	200V									
RC0201xR-07xxxxP		RC_P	0201	1/20W	25V					-55°C to 125°C	1Ω ≤ R ≤ 10MΩ Jumper < 50mΩ	Max./Min.:1MΩ/10Ω ±0.5% Max.: 10MΩ ±1%,±5%	1Ω ≤ R ≤ 10Ω -100/+500 ppm/°C 10Ω ≤ R ≤ 100Ω ±300 ppm/°C 100Ω ≤ R ≤ 10MΩ ±200 ppm/°C
RC0402xR-07xxxxP			0402	1/16W	50V					-55°C to 155°C	1Ω ≤ R ≤ 22MΩ Jumper < 50mΩ	Max./Min.: 1MΩ/10Ω ±0.5% Max.: 22MΩ ±5% Max.: 10MΩ ±1%	1Ω ≤ R ≤ 10Ω ±350 ppm/°C 10Ω ≤ R ≤ 100Ω ±200 ppm/°C 100Ω ≤ R ≤ 10MΩ ±150 ppm/°C 10MΩ ≤ R ≤ 22MΩ ±200 ppm/°C
RC0603xR-07xxxxP	0603		1/10W	75V	1Ω ≤ R ≤ 10Ω ±300 ppm/°C 10Ω ≤ R ≤ 100Ω ±200 ppm/°C 100Ω ≤ R ≤ 10MΩ ±150 ppm/°C 10MΩ ≤ R ≤ 22MΩ ±200 ppm/°C								
RC0805xR-07xxxxP	0805		1/8W	150V	1Ω ≤ R ≤ 10Ω ±300 ppm/°C 10Ω ≤ R ≤ 100Ω ±150 ppm/°C 100Ω ≤ R ≤ 10MΩ ±100 ppm/°C 10MΩ ≤ R ≤ 22MΩ ±200 ppm/°C								
RC1206xR-07xxxxP	1206		1/4W	200V	-55°C to 155°C	1Ω ≤ R ≤ 1MΩ Jumper < 50mΩ	Max./Min.:1MΩ/10Ω ±0.5% Max.: 1MΩ ±1%,±5%	1Ω ≤ R ≤ 10Ω ±300 ppm/°C 10Ω ≤ R ≤ 100Ω ±100 ppm/°C 100Ω ≤ R ≤ 10MΩ ±100 ppm/°C 10MΩ ≤ R ≤ 22MΩ ±200 ppm/°C					
RC1210xR-07xxxxP	1210		1/2W	200V									
RC1218xK-07xxxxP	1218		1W	200V									
RC2010xK-07xxxxP	2010		3/4W	200V									
RC2512xK-07xxxxP	2512		1W	200V	1Ω ≤ R ≤ 22MΩ Jumper < 50mΩ	Max./Min.: 1MΩ/10Ω ±0.5% Max.: 22MΩ ±5% Max.: 10MΩ ±1%	1Ω ≤ R ≤ 10Ω ±300 ppm/°C 10Ω ≤ R ≤ 100Ω ±100 ppm/°C 100Ω ≤ R ≤ 10MΩ ±100 ppm/°C 10MΩ ≤ R ≤ 22MΩ ±200 ppm/°C						

Note: * ! * is the symbol for new product

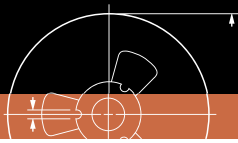

Chip Resistors General Information

Specification overview

Global part number	Series	Size	Power rating	Max. voltage	Operating Temp range	Resistance range	Tolerance	T. C. R.
RE0201xRE07xxxxL	RE	0201	1/20W	25V	-55°C to 155°C	100Ω ≤ R ≤ 1MΩ	±0.1% ±0.5% ±1%	±50 ppm/°C
RE0402xRE07xxxxL		0402	1/16W	50V		10Ω ≤ R ≤ 1MΩ		
RE0603xRE07xxxxL		0603	1/10W	75V		10Ω ≤ R ≤ 1MΩ		
RE0805xRE07xxxxL		0805	1/8W	150V		10Ω ≤ R ≤ 1MΩ		
RE1206xRE07xxxxL		1206	1/4W	200V		10Ω ≤ R ≤ 1MΩ		
YC102-xR-07xxxxL	YC	2*0201	1/32W	15V	-55°C to 125°C	10Ω ≤ R ≤ 1MΩ Jumper < 50mΩ	±1% ±5%	±200 ppm/°C
YC104-xR-07xxxxL		4*0201	1/32W	12.5V		10Ω ≤ R ≤ 1MΩ Jumper < 50mΩ		
YC122-xR-07xxxxL		2*0402	1/16W	50V	-55°C to 155°C	1Ω ≤ R ≤ 1MΩ Jumper < 50mΩ	±1% ±5%	1Ω ≤ R < 10Ω ±250 ppm/°C 10Ω ≤ R ≤ 1MΩ ±200 ppm/°C
YC124-xR-07xxxxL		4*0402	1/16W	25V		1Ω ≤ R ≤ 1MΩ Jumper < 50mΩ		
YC162-xR-07xxxxL		2*0603	1/16W	50V		1Ω ≤ R ≤ 1MΩ Jumper < 50mΩ		
YC164-xR-07xxxxL		4*0603	1/16W	50V		10Ω ≤ R ≤ 1MΩ Jumper < 50mΩ		
YC248-xR-07xxxxL		8*0602	1/16W	50V		10Ω ≤ R ≤ 1MΩ Jumper < 50mΩ		
YC324-xK-07xxxxL		4*1206	1/8W	200V		10Ω ≤ R ≤ 1MΩ Jumper < 50mΩ		
TC122-xR-07xxxxL	TC	2*0402	1/16W	50V	-55°C to 125°C	10Ω ≤ R ≤ 1MΩ Jumper < 50mΩ	±1% ±5%	±200 ppm/°C
TC124-xR-07xxxxL		4*0402	1/16W	50V		10Ω ≤ R ≤ 1MΩ Jumper < 50mΩ		
TC164-xR-07xxxxL		4*0603	1/16W	50V	-55°C to 155°C			
YC158TJR-07xxxxL	YC158T	10P8R (0612)	1/16W	25V	-55°C to 155°C	10Ω ≤ R ≤ 100KΩ	±5%	±200 ppm/°C
YC358TJx-07xxxxL YC358LJx-07xxxxL	YC358L YC358T	10P8R (1225)	1/16W	50V		10Ω ≤ R ≤ 330KΩ		±200 ppm/°C
AC0201xR-07xxxxL	AC	0201	1/20W	25V	-55°C to 155°C	1Ω ≤ R ≤ 10MΩ Jumper < 50mΩ	Max.: 10MΩ ±5%, ±1% Max./Min.: 1MΩ/10Ω ±0.5%	1Ω ≤ R ≤ 10Ω -100/+350 ppm/°C 10Ω < R ≤ 10MΩ ±200 ppm/°C
AC0402xR-07xxxxL		0402	1/16W	50V		1Ω ≤ R ≤ 22MΩ Jumper < 50mΩ	Max.: 10MΩ ±0.5%, ±1% Max./Min.: 1MΩ/10Ω ±5%	1Ω ≤ R ≤ 10Ω ±200 ppm/°C 10Ω < R ≤ 10MΩ ±100 ppm/°C 10MΩ < R ≤ 22MΩ ±200 ppm/°C
AC0603xR-07xxxxL		0603	1/10W	75V		1Ω ≤ R ≤ 1MΩ Jumper < 50mΩ	±0.5%, ±1%, ±5%	1Ω ≤ R ≤ 10Ω ±200 ppm/°C 10Ω < R ≤ 1MΩ ±100 ppm/°C
AC0805xR-07xxxxL		0805	1/8W	150V		1Ω ≤ R ≤ 22MΩ Jumper < 50mΩ	Max.: 10MΩ ±0.5%, ±1% Max./Min.: 1MΩ/10Ω ±5%	1Ω ≤ R ≤ 10Ω ±200 ppm/°C 10Ω < R ≤ 10MΩ ±100 ppm/°C 10MΩ < R ≤ 22MΩ ±200 ppm/°C
AC1206xR-07xxxxL		1206	1/4W	200V		1Ω ≤ R ≤ 10MΩ	±0.5%, ±1%, ±5%	1Ω ≤ R ≤ 10Ω ±200 ppm/°C 10Ω < R ≤ 10MΩ ±100 ppm/°C
AC1210xR-07xxxxL		1210	1/2W	200V		1Ω ≤ R ≤ 10MΩ	±0.5%, ±1%, ±5%	1Ω ≤ R ≤ 10Ω ±200 ppm/°C 10Ω < R ≤ 10MΩ ±100 ppm/°C
AC1218xK-07xxxxL		1218	1W	200V	-55°C to 155°C	1Ω ≤ R ≤ 10MΩ	±0.5%, ±1%, ±5%	1Ω ≤ R ≤ 10Ω ±200 ppm/°C 10Ω < R ≤ 10MΩ ±100 ppm/°C
AC2010xK-07xxxxL		2010	3/4W	200V				
AC2512xK-07xxxxL		2512	1W	200V				
AC0402xR-7WxxxxL		0402	1/8W	50V				
AC0603xR-7WxxxxL		0603	1/5W	75V				
AC0805xR-7WxxxxL		0805	1/4W	150V				
AC1206xR-7WxxxxL		1206	1/2W	200V				
AC1210xR-7WxxxxL		1210	1W	200V				
AC1218xK-7WxxxxL		1218	1.5W	200V				
AC2010xK-7WxxxxL		2010	1.25W	200V				
AC2512xK-7WxxxxL	2512	2W	200V					

Note: " ! " is the symbol for new product



Chip Resistors General Information

Specification overview

Global part number	Series	Size	Power rating	Max. voltage	Operating Temp range	Resistance range	Tolerance	T. C. R.			
AC0612xR-07xxxxL	AC wide	0612	3/4W	200V	-55°C to 155°C	1Ω ≤ R ≤ 1MΩ	±0.5%, ±1%, ±5%	1Ω ≤ R ≤ 10Ω ±200 ppm/°C 10Ω < R ≤ 1MΩ ±100 ppm/°C			
AC1020xK-07xxxxL		1020	1W	200V							
AC1225xK-07xxxxL		1225	2W	200V							
!AC0402xRE07xxxxL	AC 50 ppm	0402	1/16W	50V	-55°C to 155°C	10Ω ≤ R ≤ 1MΩ	±0.1%, ±0.5%, ±1%	± 50 ppm/°C			
!AC0603xRE07xxxxL		0603	1/10W	75V							
!AC0805xRE07xxxxL		0805	1/8W	150V							
!AC1206xRE07xxxxL		1206	1/4W	200V							
AF0201xR-07xxxxL	AF	0201	1/20W	25V	-55°C to 155°C	1Ω ≤ R ≤ 10MΩ Jumper < 50mΩ	±1%, ±5%, ±0.5%	1Ω ≤ R ≤ 10Ω -100/+350 ppm/°C 10Ω < R ≤ 10MΩ ±200 ppm/°C			
AF0402xR-07xxxxL		0402	1/16W	50V		1Ω ≤ R ≤ 22MΩ Jumper < 50mΩ	Max:10MΩ ±0.5%, ±1% Max:22MΩ ±5%	1Ω ≤ R ≤ 10Ω ±200 ppm/°C 10Ω < R ≤ 10MΩ ±100 ppm/°C 10MΩ < R ≤ 22MΩ ±200 ppm/°C			
AF0603xR-07xxxxL		0603	1/10W	75V							
AF0805xR-07xxxxL		0805	1/8W	150V							
AF1206xR-07xxxxL		1206	1/4W	200V		1Ω ≤ R ≤ 10MΩ Jumper < 50mΩ	±1%, ±5%, ±0.5%	1Ω ≤ R ≤ 10Ω ±200 ppm/°C 10Ω < R ≤ 10MΩ ±100 ppm/°C			
AF1210xR-07xxxxL		1210	1/2W	200V							
AF1218xK-07xxxxL		1218	1W	200V		1Ω ≤ R ≤ 10MΩ Jumper < 50mΩ	±1%, ±5%, ±0.5%	1Ω ≤ R ≤ 10Ω ±200 ppm/°C 10Ω < R ≤ 10MΩ ±100 ppm/°C			
AF2010xK-07xxxxL		2010	3/4W	200V							
AF2512xK-07xxxxL		2512	1W	200V		1Ω ≤ R ≤ 10MΩ	±0.5%, ±1%, ±5%	1Ω ≤ R ≤ 10Ω ±200 ppm/°C 10Ω < R ≤ 10MΩ ±100 ppm/°C			
!AF0402xR-7WxxxxL		0402	1/8W	50V							
!AF0603xR-7WxxxxL		0603	1/5W	75V							
!AF0805xR-7WxxxxL		0805	1/4W	150V							
!AF1206xR-7WxxxxL		1206	1/2W	200V							
AF122-xR-07xxxxL		2*0402	1/16W	50V					1Ω ≤ R ≤ 1MΩ Jumper < 50mΩ	Max.: 1MΩ ±5% Max./Min.: 1MΩ/10Ω ±1%	1Ω ≤ R ≤ 10Ω ±250 ppm/°C 10Ω < R ≤ 1MΩ ±200 ppm/°C
AF124-xR-07xxxxL		4*0402	1/16W	25V						±1%, ±5%	
AF162-xR-07xxxxL		2*0603	1/16W	50V		±1%, ±5%					
AF164-xR-07xxxxL		4*0603	1/16W	50V		±1%, ±5%	±250 ppm/°C				
AA0201xR-07xxxxL		AA	0201	1/20W		25V	-55°C to 155°C	1Ω ≤ R ≤ 10MΩ Jumper < 50mΩ	±0.5%, ±1%, ±5%	1Ω ≤ R ≤ 10Ω -100/+400 ppm/°C 10Ω < R ≤ 10MΩ ±300 ppm/°C	
AA0402xR-07xxxxL			0402	1/16W		50V		1Ω ≤ R ≤ 22MΩ Jumper < 50mΩ	Max:22MΩ, ±5% Max:10MΩ, ±0.5%, ±1%	1Ω ≤ R ≤ 10Ω ±200 ppm/°C 10Ω < R ≤ 10MΩ ±150 ppm/°C 10MΩ ≤ R ≤ 22MΩ ±200 ppm/°C	
AA0603xR-07xxxxL	0603		1/10W	75V							
AA0805xR-07xxxxL	0805		1/8W	150V							
AA1206xR-07xxxxL	1206		1/4W	200V	1Ω ≤ R ≤ 1MΩ Jumper < 50mΩ	±0.5%, ±1%, ±5%		1Ω ≤ R ≤ 10Ω ±200 ppm/°C 10Ω < R ≤ 10MΩ ±150 ppm/°C 10MΩ ≤ R ≤ 22MΩ ±200 ppm/°C			
AA1210xR-07xxxxL	1210		1/2W	200V							
AA1218xK-07xxxxL	1218		1W	200V	1Ω ≤ R ≤ 22MΩ Jumper < 50mΩ	Max:22MΩ, ±5% Max:10MΩ, ±0.5%, ±1%		1Ω ≤ R ≤ 10Ω ±200 ppm/°C 10Ω < R ≤ 10MΩ ±150 ppm/°C 10MΩ ≤ R ≤ 22MΩ ±200 ppm/°C			
AA2010xK-07xxxxL	2010		3/4W	200V							
AA2512xK-07xxxxL	2512		1W	200V							

Note: "!" is the symbol for new product

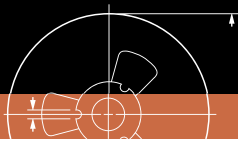

Chip Resistors General Information

Specification overview

Global part number	Series	Size	Power rating	Max. voltage	Operating Temp range	Resistance range	Tolerance	T. C. R.
SR0402xR-07xxxxL	SR	0402	1/16W	50V	-55°C to 155°C	1Ω ≤ R ≤ 1MΩ	±0.5% ±1% ±5% ±10% ±20%	±200 ppm/°C
SR0402xR-7WxxxxL			1/8W					
ISR0402xR-7TxxxxL			1/5W					
SR0603xR-07xxxxL		0603	1/10W	75V				
SR0603xR-7WxxxxL			1/5W					
SR0603xR-7TxxxxL			1/4W					
SR0805xR-07xxxxL		0805	1/8W	150V				
SR0805xR-7WxxxxL			1/4W					
SR0805xR-7TxxxxL			1/3W					
ISR0805xR-47xxxxL			1/2W					
SR1206xR-07xxxxL		1206	1/4W	200V				
SR1206xR-7WxxxxL			1/2W					
ISR1206xR-7TxxxxL			3/4W					
ISR1206xR-47xxxxL			1W					
SR1210xR-07xxxxL		1210	1/2W	200V				
SR1210xR-7WxxxxL			1W	200V				
SR1218xK-07xxxxL		1218	1W	200V				
ISR1218xK-7WxxxxL			1.5W					
SR2010xK-07xxxxL		2010	3/4W	200V				
ISR2010xK-7WxxxxL			1.25W					
SR2512xK-07xxxxL	2512	1W	200V					
ISR2512xK-7WxxxxL		2W						
RV0603xR-07xxxxL	RV	0603	1/10W	350V	-55°C to 155°C	47Ω ≤ R ≤ 10MΩ	±0.5%, ±1%, ±5%	±100 ppm/°C ±200 ppm/°C
RV0805xR-07xxxxL		0805	1/8W	400V		47Ω ≤ R ≤ 22MΩ	Max.: 22MΩ ±5%, ±1% Max.: 10MΩ ±0.5%	
RV1206xR-07xxxxL		1206	1/4W	500V		47Ω ≤ R ≤ 27MΩ	Max.: 27MΩ ±5%, ±1% Max.: 15MΩ ±0.5%	
RV2010xK-07xxxxL		2010	3/4W			47Ω ≤ R ≤ 22MΩ	Max.: 22MΩ ±5%, ±1% Max.: 10MΩ ±0.5%	
RV2512xK-07xxxxL		2512	1W			47Ω ≤ R ≤ 16MΩ	Max.: 16MΩ ±5%, ±1% Max.: 10MΩ ±0.5%	
CP0201xR-07xxxxL	CP	0201	1/20W	25V	-55°C to 125°C	10Ω~1MΩ	±1%, ±5%	±200 ppm/°C
RT0201xRx07xxxxL	RT	0201	1/20W	25V	-55°C to 125°C	22Ω ≤ R ≤ 75KΩ	±0.1%, ±0.25%, ±0.5%, ±1%	±5 ppm/°C ±10 ppm/°C ±15 ppm/°C ±25 ppm/°C ±50 ppm/°C
RT0402xRx07xxxxL		0402	1/16W	50V	-55°C to 155°C	4.7Ω ≤ R ≤ 240KΩ	±0.01% ±0.02% ±0.05% ±0.1% ±0.25% ±0.5% ±1%	
RT0603xRx07xxxxL		0603	1/10W	75V		1Ω ≤ R ≤ 1MΩ		
RT0805xRx07xxxxL		0805	1/8W	150V		1Ω ≤ R ≤ 1.5MΩ		
RT1206xRx07xxxxL		1206	1/4W	200V		1Ω ≤ R ≤ 1.5MΩ		
RT1210xRx07xxxxL		1210	1/4W		-55°C to 125°C	4.7Ω ≤ R ≤ 1MΩ		
RT2010xKx07xxxxL		2010	1/2W			4.7Ω ≤ R ≤ 1MΩ		
RT2512xKx07xxxxL		2512	3/4W		4.7Ω ≤ R ≤ 1MΩ			

Note: "!" is the symbol for new product



Chip Resistors General Information

Specification overview

Global part number	Series	Size	Power rating	Max. voltage	Operating Temp range	Resistance range	Tolerance	T. C. R.		
!AT0402xRx07xxxxL	AT	0402	1/16W	50V	-55°C to 155°C	$10\Omega \leq R \leq 100K\Omega$	±0.1% ±0.25% ±0.5% ±1%	±15 ppm/°C ±25 ppm/°C ±50 ppm/°C		
!AT0603xRx07xxxxL		0603	1/10W	75V		$10\Omega \leq R \leq 330K\Omega$				
!AT0805xRx07xxxxL		0805	1/8W	150V		$10\Omega \leq R \leq 1M\Omega$				
!AT1206xRx07xxxxL		1206	1/4W	200V						
RL0402xR-07xxxxL	RL	0402	1/16W	(PxR) ^{1/2}	-55°C to 155°C	$50m\Omega \leq R < 1\Omega$	±1% ±2% ±5%	See table T. C. R. - RL series		
RL0603xR-07xxxxL		0603	1/10W						$10m\Omega \leq R < 1\Omega$	
RL0805xR-07xxxxL		0805	1/8W							
RL1206xR-07xxxxL		1206	1/4W							
RL1210xR-07xxxxL		1210	1/2W							
RL1218xK-07xxxxL		1218	1W			$10m\Omega \leq R < 1\Omega$				
RL2010xK-07xxxxL		2010	3/4W							
RL2512xK-07xxxxL		2512	1W							
RL0805xR-7WxxxxL		0805	1/4W			-55°C to 125°C			$10m\Omega \leq R < 1\Omega$	
RL1206xR-7WxxxxL		1206	1/2W							
PT0402xR-07xxxxL	PT	0402	1/16W	(PxR) ^{1/2}	-55°C to 155°C	$50m\Omega \leq R < 1\Omega$	±1% ±2% ±5%	See table T.C.R. - PT series		
PT0603xR-07xxxxL		0603	1/10W						$50m\Omega \leq R < 1\Omega$	
PT0805xR-07xxxxL		0805	1/8W						$50m\Omega \leq R < 1\Omega$	
PT1206xR-07xxxxL		1206	1/4W							
PT2010xK-07xxxxL		2010	3/4W						$100m\Omega \leq R < 1\Omega$	
PT2512xK-07xxxxL		2512	1W							
PT0402xR-7WxxxxL		0402	1/8W							
PT0603xR-7WxxxxL		0603	1/5W						$50m\Omega \leq R < 1\Omega$	
PT0805xR-7WxxxxL		0805	1/4W							
PT1206xR-7WxxxxL		1206	1/2W							
PT2010xK-7WxxxxL		2010	1W						$100m\Omega \leq R < 1\Omega$	
PT2512xK-7WxxxxL		2512	2W							
PT0603xR-7TxxxxL		0603	1/3W							$50m\Omega \leq R \leq 68m\Omega$

Note: " ! " is the symbol for new product



Chip Resistors General Information

Specification overview

Global part number	Series	Size	Power rating	Max. voltage	Operating Temp. range	Resistance range	Tolerance	T. C. R.		
!PA0201xRL07xxxxxL	PA	0201	1/20W	$(P \times R)^{1/2}$	-55°C to 125°C	5mΩ ≤ R ≤ 10mΩ Jumper < 5mΩ	±1% ±5%	±150 ppm/°C		
!PA0201xRL7WxxxxxL			1/10W							
!PA0201xRL7TxxxxxL			3/20W							
!PA0201xRL47xxxxxL			1/5W							
!PA0402xRL07xxxxxL		0402	1/16W			-55°C to 125°C			2.5mΩ 5mΩ ≤ R ≤ 20mΩ Jumper < 1mΩ	±150 ppm/°C
!PA0402xRL7WxxxxxL			1/8W							
!PA0402xRL7TxxxxxL			1/6W							
!PA0402xRL47xxxxxL			1/4W							
!PA0402xRL57xxxxxL			1/3W							
!PA0603xRx07xxxxxL		0603	1/10W			-55°C to 155°C			1mΩ ≤ R ≤ 20mΩ Jumper < 0.2mΩ	1mΩ ±100 ppm/°C 2mΩ/ 2.5mΩ ±150 ppm/°C ±50 ppm/°C 3mΩ~20mΩ ±75 ppm/°C ±100 ppm/°C
!PA0603xRx7WxxxxxL			1/5W							
!PA0603xRx7TxxxxxL			1/3W							
!PA0603xRx47xxxxxL			2/5W							
!PA0603xRx57xxxxxL			1/2W							
!PA0805xRx07xxxxxL		0805	1/8W		-55°C to 155°C	1mΩ ≤ R ≤ 20mΩ Jumper < 0.2mΩ	1mΩ ±150 ppm/°C 2mΩ ±100 ppm/°C 3mΩ ~20mΩ ± 50 ppm/°C			
!PA0805xRx7WxxxxxL			1/4W							
!PA0805xRx47xxxxxL			1/2W							
!PA0805xRx87xxxxxL			1W							
!PA1206xRx07xxxxxL		1206	1/4W		-55°C to 170°C	1mΩ ≤ R ≤ 50mΩ	1mΩ ≤ R ≤ 2mΩ ±75 ppm/°C ±100 ppm/°C 3mΩ ≤ R ≤ 50mΩ ±50 ppm/°C ±75 ppm/°C ±100 ppm/°C			
!PA1206xRx7WxxxxxL			1/2W							
!PA1206xRx47xxxxxL	1W									
!PA2512xKx07xxxxxE	2512	1W	-55°C to 170°C	0.5mΩ ≤ R ≤ 100mΩ	±50 ppm/°C ±75 ppm/°C ±100 ppm/°C					
!PA2512xKx7WxxxxxE		2W								
!PA2512xKx7TxxxxxE		3W								
!PA1206xRE07xxxxxZ	1206	1/4W	-55°C to 170°C	5mΩ ≤ R ≤ 20mΩ	±0.5%	±50ppm°C				
!PA1206xRE7WxxxxxZ		1/2W		1mΩ ≤ R ≤ 20mΩ						
!PA1206xRE47xxxxxZ		1W								
!PA2010xKE07xxxxxZ	2010	1/2W	-55°C to 170°C	1mΩ ≤ R ≤ 20mΩ	±1% ±5%	±50ppm°C				
!PA2010xKE7WxxxxxZ		1W								
!PA2010xKE47xxxxxZ		2W								
!PA2010xKE67xxxxxZ		3W								

Note: "!" is the symbol for new product



Chip Resistors General Information

Specification overview

Global part number	Series	Size	Power rating	Max. voltage	Operating Temp. range	Resistance range	Tolerance	T. C. R.		
!PE0100xRx07xxxxL	PE	01005	1/32W	(PxR) ^{1/2}	-55°C to 125°C	200mΩ ≤ R ≤ 500mΩ	±1% ±5%	200mΩ ≤ R < 300mΩ ±300 ppm/°C 300mΩ ≤ R ≤ 500mΩ ±200 ppm/°C		
!PE0100xRx7WxxxxL			1/16W							
!PE0201xRx07xxxxL		0201	1/20W			-55°C to 170°C	50mΩ ≤ R ≤ 200mΩ	±0.5% (>10mΩ) ±1% ±5%	50mΩ ≤ R ≤ 70mΩ ±350 ppm/°C 70mΩ < R ≤ 200mΩ ±100 ppm/°C	
!PE0201xRx7WxxxxL			1/10W							
!PE0402xRx07xxxxL		0402	1/16W				10mΩ ≤ R ≤ 910mΩ	±100 ppm/°C		
!PE0402xRx7WxxxxL			1/8W							
!PE0402xRx7TxxxxL			1/6W							
!PE0402xRx47xxxxL			1/4W							
!PE0603xRx07xxxxL		0603	1/10W				5mΩ ≤ R ≤ 910mΩ	±75 ppm/°C ±100 ppm/°C		
!PE0603xRx7WxxxxL			1/5W							
!PE0603xRx7TxxxxL			1/3W							
!PE0603xRx47xxxxxL			2/5W							
!PE0603xRx57xxxxxL			1/2W							
!PE0805xRx07xxxxxL			0805		1/8W	5mΩ ≤ R ≤ 19mΩ ±75 ppm/°C ±100 ppm/°C ±50 ppm/°C 20mΩ ≤ R ≤ 910mΩ ±75 ppm/°C ±100 ppm/°C				
!PE0805xRx7WxxxxxL		1/4W								
!PE0805xRx7TxxxxxL		1/3W								
!PE0805xRx47xxxxxL		1/2W								
!PE1206xRx07xxxxxL		1206	1/4W		5mΩ ≤ R ≤ 910mΩ	±50 ppm/°C ±75 ppm/°C ±100 ppm/°C				
!PE1206xRx7WxxxxxL			1/2W							
!PE1206xRx47xxxxxL			1W							
!PE2010xKx07xxxxxL	2010	1/2W	5mΩ ≤ R ≤ 910mΩ	±50 ppm/°C ±75 ppm/°C ±100 ppm/°C						
!PE2010xKx7WxxxxxL		1W								
!PE2512xKx07xxxxxL	2512	1W	6mΩ ≤ R ≤ 910mΩ	±50 ppm/°C ±75 ppm/°C ±100 ppm/°C						
!PE2512xKx7WxxxxxL		2W								
!PE0508xRx07xxxxxL	PE (Wide)	0508	1W	(PxR) ^{1/2}	-55°C to 155°C	5mΩ ≤ R ≤ 1Ω	±1% ±5%	5mΩ ≤ R < 75mΩ ±100 ppm/°C 75mΩ ≤ R ≤ 1Ω ±50 ppm/°C		
!PE0612xKx07xxxxxL		0612	1W						1mΩ ≤ R ≤ 1Ω	1mΩ ±150 ppm/°C 2mΩ ±100 ppm/°C 3mΩ ≤ R ≤ 1Ω ±50 ppm/°C ±75 ppm/°C ±100 ppm/°C
!PE0815xKx07xxxxL		0815	1/2W							
!PE0815xKx7WxxxxL			1W							
!PS0306xRx07xxxxxL	PS (4 Termination)	0306	1/4W	(PxR) ^{1/2}	-55°C to 125°C	2mΩ ≤ R ≤ 100mΩ	±1% ±5%	5mΩ ≤ R < 100mΩ ±75 ppm/°C ±100 ppm/°C 2mΩ ≤ R < 5mΩ ±150 ppm/°C		
!PS0306xRx7WxxxxxL			1/3W							
!PS0306xRx7TxxxxxL			1/2W							
!PS0612xKx07xxxxxL		0612	1W		0.5mΩ ≤ R ≤ 10mΩ -55°C to 150°C 12mΩ ≤ R ≤ 100mΩ -55°C to 125°C	0.5mΩ 1mΩ ≤ R ≤ 100mΩ	0.5mΩ ±300 ppm/°C 1mΩ ±150 ppm/°C 10mΩ ≤ R ≤ 13mΩ ±200 ppm/°C 2mΩ ≤ R ≤ 9mΩ ±100 ppm/°C 14mΩ ≤ R ≤ 100mΩ ±100 ppm/°C			
!PS1206xRx07xxxxL		1206	1/2W		-40°C to 125°C	10mΩ ≤ R ≤ 100mΩ	±50 ppm/°C ±75 ppm/°C ±100 ppm/°C			
PS1225xKx07xxxxL		1225	3W		(PxR) ^{1/2}	-55°C to 150°C	3mΩ ≤ R ≤ 100mΩ	±1% ±5%	3mΩ ±500ppm/°C 4mΩ ≤ R ≤ 100mΩ ±100ppm/°C	

Note: "*" is the symbol for new product



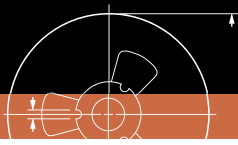

Chip Resistors General Information

Specification overview

Global part number	Series	Size	Power rating	Max. voltage	Operating Temp. range	Resistance range	Tolerance	T. C. R.		
IPU2512xKx07xxxxL	PU	2512	4W	(PxR) ^{1/2}	-55°C to 170°C	3mΩ / 4mΩ / 5mΩ	±1% ±5%	0.3mΩ / 0.5mΩ ±200 ppm/°C 1mΩ ±175 ppm/°C 2mΩ~5mΩ ±75 ppm/°C		
IPU2512xKxP5xxxxL			5W			1mΩ / 2mΩ				
IPU2512xKxP6xxxxL			6W			0.3mΩ / 0.5mΩ				
IPU3921xKx13xxxxL		3921	3W		-55°C to 170°C	0.2mΩ / 0.25mΩ / 0.3mΩ / 0.4mΩ / 0.5mΩ / 0.7mΩ 1mΩ / 2mΩ / 3mΩ / 4mΩ / 5mΩ		0.2mΩ / 0.25mΩ / 0.3mΩ / 0.4mΩ / ±175 ppm/°C 0.5mΩ / 0.7mΩ		
					-55°C to 275°C	0.5mΩ / 1mΩ / 2mΩ / 3mΩ / 4mΩ		1mΩ~5mΩ ±75 ppm/°C		
IPU3921xKxP5xxxxL			5W		-55°C to 170°C	0.2mΩ / 0.25mΩ / 0.3mΩ / 0.4mΩ / 0.5mΩ / 0.7mΩ 1mΩ / 2mΩ / 3mΩ / 4mΩ / 5mΩ		0.2mΩ / 0.25mΩ 0.3mΩ / 0.4mΩ ±175 ppm/°C 0.5mΩ / 0.7mΩ		
IPU3921xKxP9xxxxL			9W			0.2mΩ / 0.25mΩ / 0.3mΩ / 0.4mΩ / 0.5mΩ / 0.7mΩ / 1mΩ		1mΩ~5mΩ ±75 ppm/°C		
IPU5931xKx13xxxxL			5931		5W	-55°C to 170°C		0.2mΩ / 0.3mΩ / 0.5mΩ / 1mΩ / 2mΩ / 3mΩ / 4mΩ	0.1mΩ ±300 ppm/°C 0.2mΩ ±225 ppm/°C 0.3mΩ / 0.5mΩ ±175 ppm/°C 1mΩ~4mΩ ±75 ppm/°C	
		-55°C to 275°C				0.3mΩ / 0.5mΩ / 1mΩ / 2mΩ / 3mΩ / 4mΩ				
		-55°C to 170°C			7W	0.2mΩ / 0.3mΩ / 0.5mΩ / 1mΩ / 2mΩ / 3mΩ / 4mΩ				
					10W	0.2mΩ / 0.3mΩ / 0.5mΩ				
IPU5931xKxPAxxxxL		15W			0.1mΩ					
IPU6820JKF070U1L		6820	36W			-65°C to 170°C		0.1mΩ	±5%	±100 ppm/°C
IPU8518xKx070UxxxL		8518	36W			-65°C to 170°C		0.05mΩ / 0.1mΩ / 0.125mΩ / 0.25mΩ	±5% ±10%	0.05mΩ ±200 ppm/°C 0.1mΩ / 0.125mΩ ±175 ppm/°C 0.25mΩ ±100 ppm/°C
IPU8420xKE070UxxxL		8420	36W			-40°C to 170°C		0.05mΩ / 0.1mΩ	±5%	±50 ppm/°C
IPU8420JKExx0UxxxE	15W		0.1mΩ	±50 ppm/°C						
IPU8420JKP640U035N	15W		0.035mΩ	±250 ppm/°C						
AR0402xR-07xxxxL	AR	0402	1/16W	50V	-55°C to 155°C	1Ω ≤ R ≤ 10MΩ Jumper < 50mΩ	±1% ±5%	1Ω ≤ R ≤ 10Ω ±200 ppm/°C 10Ω < R ≤ 10MΩ ±100 ppm/°C		
AR0603xR-07xxxxL		0603	1/10W							
AR0805xR-07xxxxL		0805	1/8W							
AR1206xR-07xxxxL		1206	1/4W							
TR0402xR-07xxxxL	TR	0402	1/16W	50V	-55°C to 125°C	1Ω ≤ R ≤ 10MΩ	+0/-10% +0/-20% +0/-30%	1Ω ≤ R ≤ 10Ω ±200 ppm/°C 10Ω < R ≤ 1MΩ ±100 ppm/°C 1MΩ < R ≤ 10MΩ ±200 ppm/°C		
TR0603xR-07xxxxL		0603	1/16W							
TR0805xR-07xxxxL		0805	1/8W	150V	-55°C to 155°C					
TR1206xR-07xxxxL		1206	1/4W							
ATV321xR-07xxxxL	ATV	0404	40mW	50V	-55°C to 125°C	-1dB to -20dB	±0.3dB ±0.5dB ±1.0dB ±2.0dB	--		

Note: " ! " is the symbol for new product



Chip Resistors General Information

Ordering information - Global part number

Global part number - Single resistor ⁽³⁾

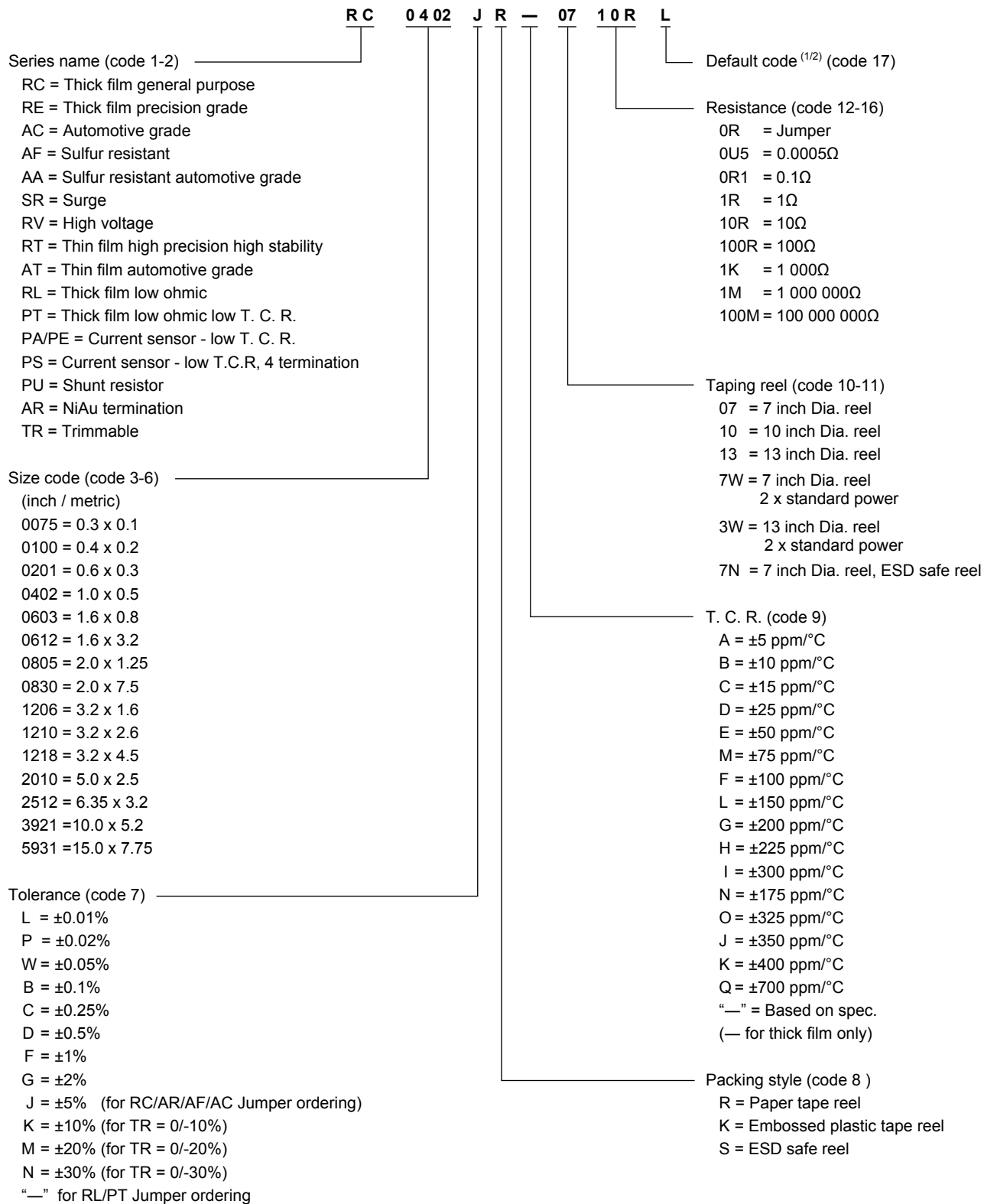

Note: 1. All of our RSMD products are RoHS compliant. "LFP" of the internal 2D reel label mentions "Lead Free Process"

2. Letter L is system default code for ordering only

3. Global Part Number is the preferred clear text code for ordering Yageo and Phycomp branded products.



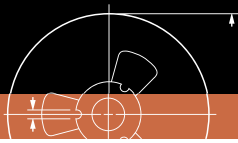

Chip Resistors General Information

Ordering information - Global part number

Global part number - Power enhancement

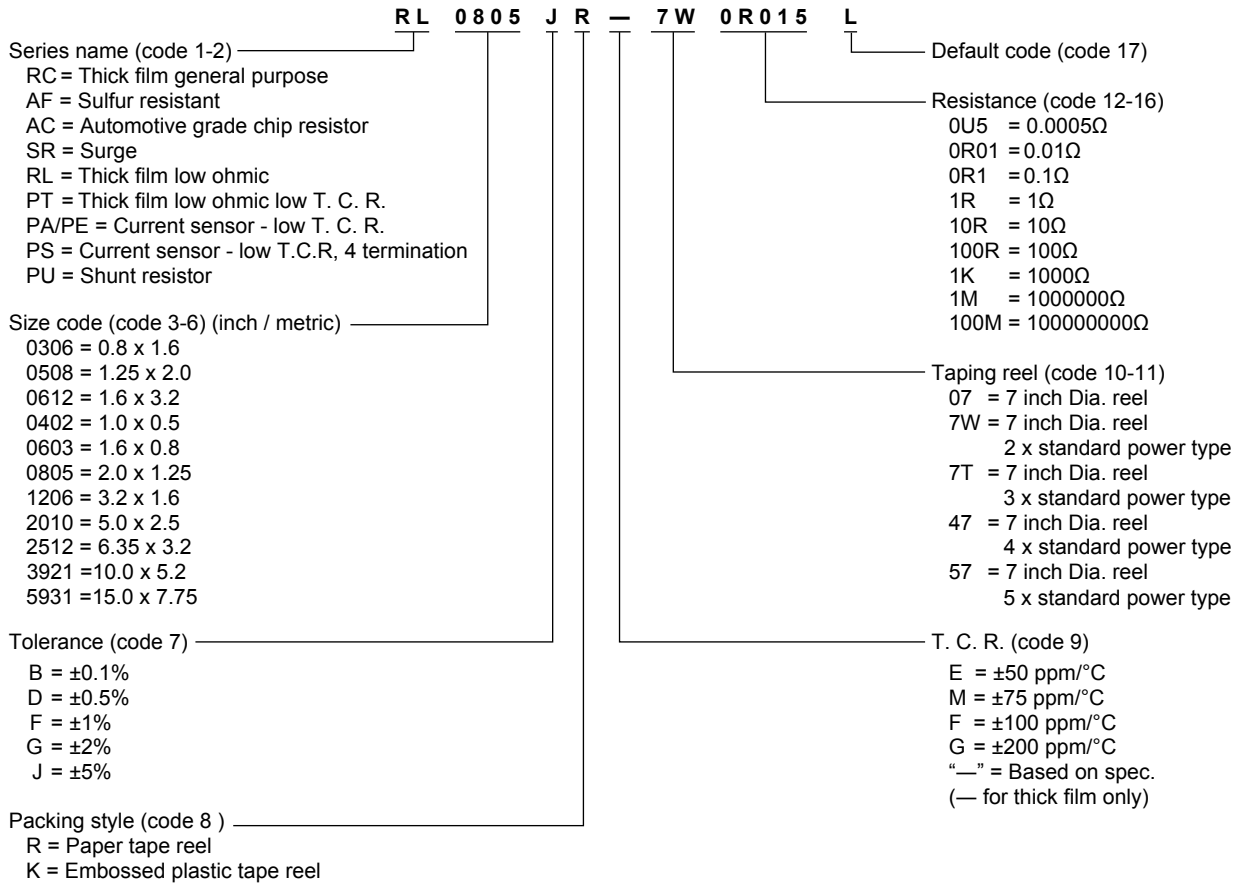

Global part number - Arrays & Networks

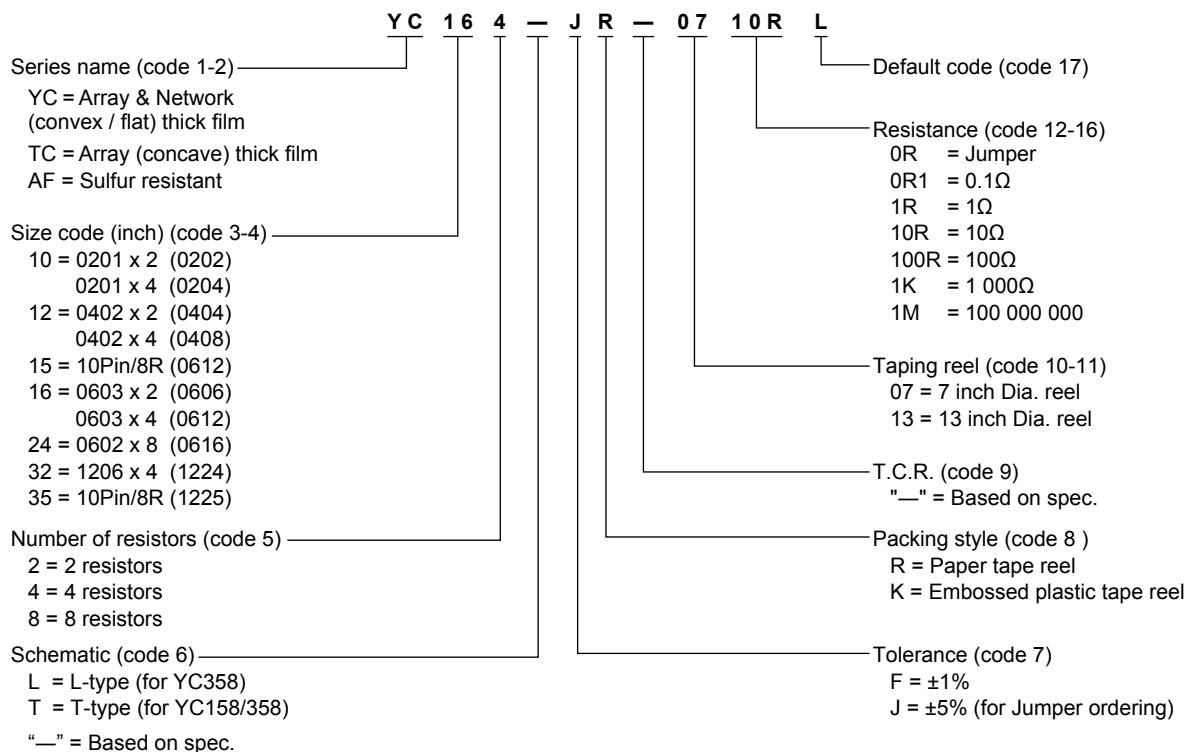

Chip Resistors General Information

Ordering information - North America

Phycomp CTC ordering code - North America

Ordering example: 9C06031A10R0FKHFT = R-Chip 0603, 10R0, 1%, 5K reel

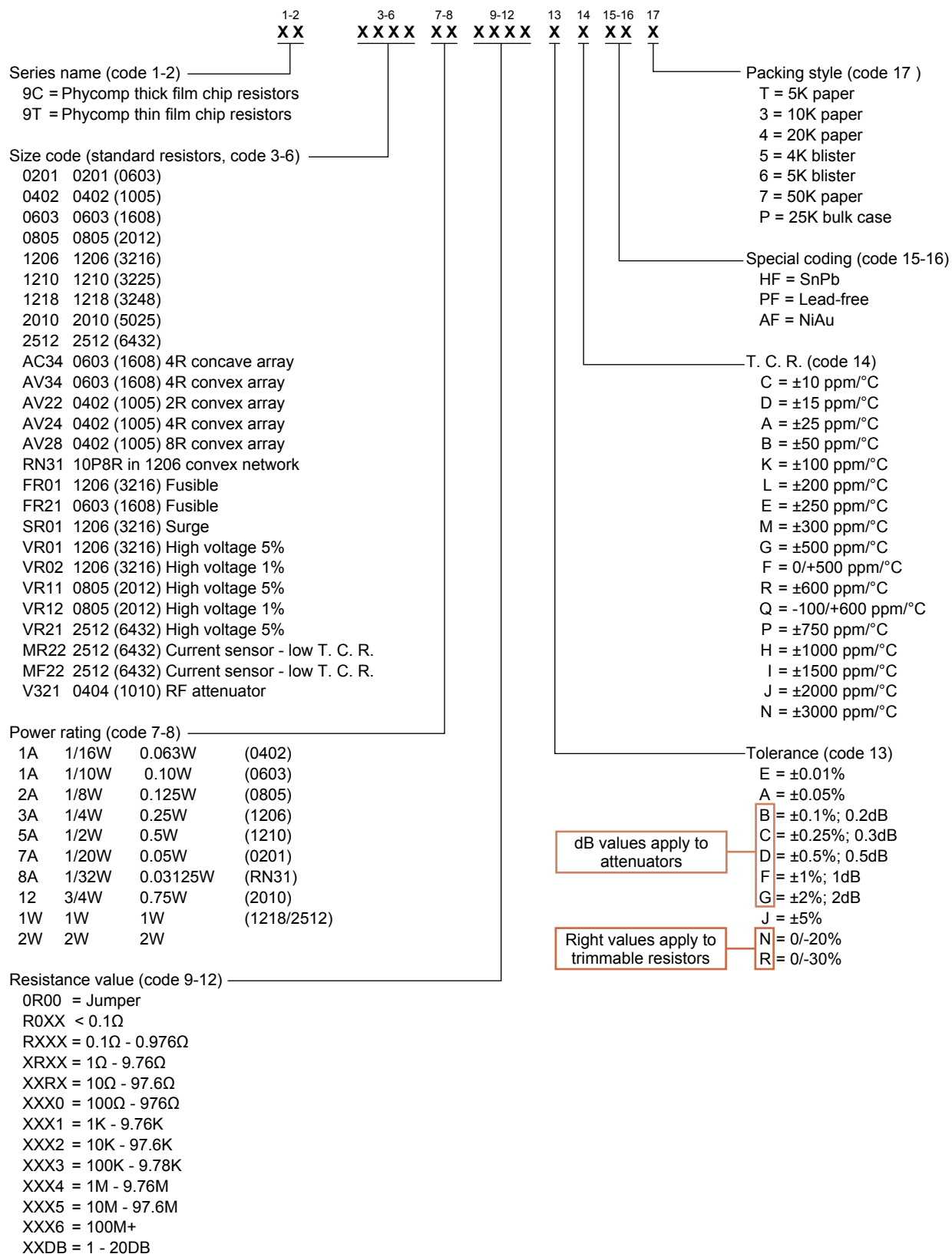

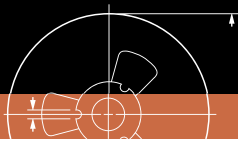

Chip Resistors General Information

IEC publication 63, SPQ, last digit of 12NC

Standard of values in a decade according to "IEC publication 63"												
E24 series	10	11	12	13	15	16	18	20	22	24	27	30
	33	36	39	43	47	51	56	62	68	75	82	91
E96 series	100	102	105	107	110	113	115	118	121	124	127	130
	133	137	140	143	147	150	154	158	162	165	169	174
	178	182	187	191	196	200	205	210	215	221	226	232
	237	243	249	255	261	267	274	280	287	294	301	309
	316	324	332	340	348	357	365	374	383	392	402	412
	422	432	442	453	464	475	487	499	511	523	536	549
	562	576	590	604	619	634	649	665	681	698	715	732
	750	768	787	806	825	845	866	887	909	931	953	976

Packing quantities								
Size code	Tape width	178mm / Ø7" reel		254mm/Ø10" reel	330mm / Ø13" reel		Weight g /100pcs	Volume mm ³
		Paper	Embossed	Paper	Paper	Embossed		
0075	4mm	40000	---	---	---	---		
0100	8mm	20000	---	---	---	---	0.007	0.0104
0201	8mm	10000 / 20000	---	---	80000	---	0.016	0.041
0306	4mm	5000	---	---	---	---		
0402	8mm	10000 / 20000	---	20000	50000	---	0.058	0.175
0508	8mm	5000	---	---	---	---		
0603	8mm	5000	---	10000	20000	---	0.192	0.576
0612	8mm	4000	4000	---	---	---	0.862	2.728
0805	8mm	4000 / 5000	---	10000	20000	---	0.450	1.250
1020	12mm	---	4000	---	---	---		
1206	8mm	4000 / 5000	---	10000	20000	---	0.862	2.728
1210	8mm	5 000	---	10000	20000	---	1.471	4.030
1218	12mm	---	4000	---	---	---	2.703	7.590
1225	12mm	---	4000	---	---	---		
2010	12mm	---	4000	---	---	16000	2.273	6.875
2512	12mm	---	4000	---	---	---	3.704	10.827
YC102	8mm	10000	---	---	---	---	0.052	---
YC104	8mm	10000	---	---	---	---	0.099	---
AF/YC122	8mm	10000	---	---	50000	---	0.100	---
TC122	8mm	10000	---	---	50000	---	0.112	---
ATV321	8mm	10000	---	---	---	---	0.100	---
AF/YC124	8mm	10000	---	20000	40000	---	0.281	---
TC124	8mm	10000	---	20000	40000	---	0.311	---
AF/YC162	8mm	5000	---	---	---	---	0.376	---
AF/YC164	8mm	5000	---	10000	20000	---	0.833	---
TC164	8mm	5000	---	10000	20000	---	1.030	---
YC158T	8mm	5000	---	---	20000	---	0.855	---
YC248	12mm	5000	4000	---	---	---	0.885	---
YC324	12mm	---	4000	---	---	---	2.703	---
YC358T YC358L	12mm	---	4000	---	---	---	3.333	---

12NC Ordering information

The first 8 or 9 digits of the 12 digit catalogue number are given under section "Phycomp worldwide - Traditional type" on following pages.

The remaining 4 or 3 digits represent the resistance value with the last digit indicating the multiplier as shown in table on the right.

Example:

- 0.001 Ω = 0010 or 010
- 0.02 Ω = 0200 or 200
- 0.3 Ω = 3007 or 307
- 1 Ω = 1008 or 108
- 33 kΩ = 3303 or 333
- 10 MΩ = 1006 or 106

Last digit of 12NC	
Resistance	Last digit
0.001 to 0.0976 Ω	0
0.1 to 0.976 Ω	7
1 to 9.76 Ω	8
10 to 97.6 Ω	9
100 to 976 Ω	1
1 to 9.76 kΩ	2
10 to 97.6 kΩ	3
100 to 976 kΩ	4
1 to 9.76 MΩ	5
10 to 97.6 MΩ	6



Chip Resistors Selection Charts

RC - Thick film general purpose chip resistors, 0075 to 2512

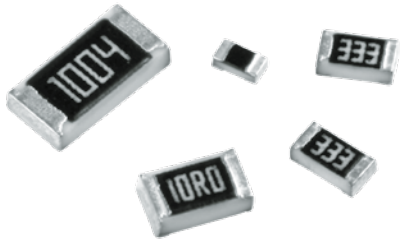

Features

- Extremely thin and light (0075 & 0100)
- Highly reliable construction
- Compatible with all soldering processes
- Highly stable in auto-placement surface mounting applications
- Jumper is available
- Available in 8mm tape & reel per IEC 60286-3 (EIA -RS 481)

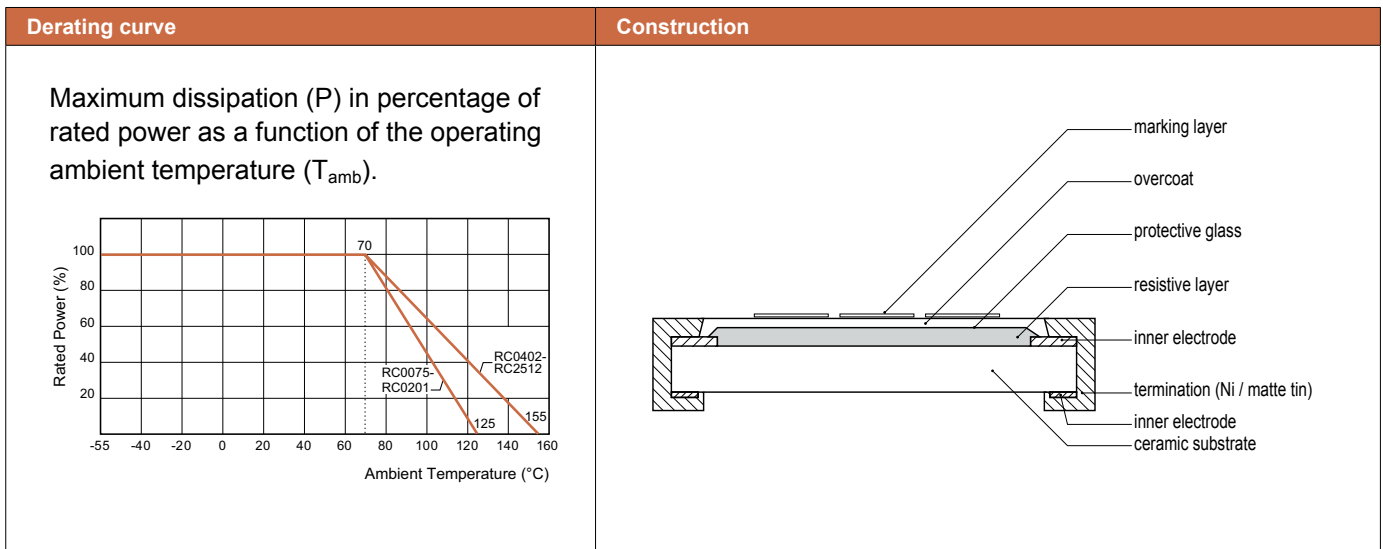

Dimensions						
Type	L	W	H	l_1	l_2	
RC0075	0.30 ± 0.01	0.15 ± 0.01	0.13 ± 0.01	0.08 ± 0.03	0.08 ± 0.03	
RC01005	0.40 ± 0.02	0.20 ± 0.02	0.13 ± 0.02	0.10 ± 0.03	0.10 ± 0.03	
RC0201	0.60 ± 0.03	0.30 ± 0.03	0.23 ± 0.03	0.10 ± 0.05	0.15 ± 0.05	
RC0402	1.00 ± 0.05	0.50 ± 0.05	0.32 ± 0.05	0.20 ± 0.10	0.25 ± 0.10	
RC0603	1.60 ± 0.10	0.80 ± 0.10	0.45 ± 0.10	0.25 ± 0.15	0.25 ± 0.15	
RC0805	2.00 ± 0.10	1.25 ± 0.10	0.50 ± 0.10	0.35 ± 0.20	0.35 ± 0.20	
RC1206	3.10 ± 0.10	1.60 ± 0.10	0.55 ± 0.10	0.45 ± 0.20	0.40 ± 0.20	
RC1210	3.10 ± 0.10	2.60 ± 0.15	0.55 ± 0.10	0.45 ± 0.15	0.50 ± 0.20	
RC1218	3.10 ± 0.10	4.60 ± 0.10	0.55 ± 0.10	0.45 ± 0.20	0.40 ± 0.20	
RC2010	5.00 ± 0.10	2.50 ± 0.15	0.55 ± 0.10	0.45 ± 0.15	0.50 ± 0.20	
RC2512	6.35 ± 0.10	3.10 ± 0.15	0.55 ± 0.10	0.60 ± 0.20	0.50 ± 0.20	



Chip Resistors Selection Charts

RC - Thick film general purpose chip resistors, 0075 to 2512

Electrical characteristics								
Type	Power P ₇₀	Operating Temp. range	MWV	RCOV	DWV	Resistance range & tolerance	T. C. R.	Jumper criteria (unit: A)
RC0075	1/50W	-55°C to +125°C	10V	25V	25V	E24 ±5% 10Ω ≤ R ≤ 1MΩ E24/E96 ±1% 10Ω ≤ R ≤ 1MΩ	10Ω ≤ R < 100Ω -200 / ±600 ppm/°C 100Ω ≤ R ≤ 1MΩ ±200 ppm/°C	Rated current 0.5 Max. current 1.0
RC0100	1/32W		15V	30V	30V	E24 ±5% 1Ω ≤ R ≤ 22MΩ E24/E96 ±1% 1Ω ≤ R ≤ 10MΩ E24/E96 ±0.5% 33Ω ≤ R ≤ 470KΩ Jumper < 50mΩ	1Ω ≤ R < 10Ω -200 /±600 ppm/°C 10Ω ≤ R < 100Ω ±300 ppm/°C 100Ω ≤ R ≤ 10MΩ ±200 ppm/°C 10MΩ < R ≤ 22MΩ ±250 ppm/°C	Rated current 0.5 Max. current 1.0
RC0201	1/20W		25V	50V	50V	E24 ±5% 1Ω ≤ R ≤ 10MΩ E24/E96 ±1% 1Ω ≤ R ≤ 10MΩ E24/E96 ±0.1%,±0.5% 10Ω ≤ R ≤ 1MΩ Jumper < 50mΩ	10Ω < R ≤ 10MΩ ±200 ppm/°C 1Ω ≤ R ≤ 10Ω -100 / ±350 ppm/°C	Rated current 0.5 Max. current 1.0
RC0402	1/16W	-55°C to +155°C	50V	100V	100V	E24 ±5% 1Ω ≤ R ≤ 22MΩ E24/E96 ±1% 1Ω ≤ R ≤ 10MΩ E24/E96 ±0.1%,±0.5% 10Ω ≤ R ≤ 1MΩ Jumper < 50mΩ	1Ω ≤ R ≤ 10Ω ±200 ppm/°C 10Ω < R ≤ 10MΩ ±100 ppm/°C 10MΩ < R ≤ 22MΩ ±200 ppm/°C	Rated current 1.0 Max. current 2.0
	1/8W		50V	100V	100V	E24 ±5% 1Ω ≤ R ≤ 1MΩ E24/E96 ±1% 1Ω ≤ R ≤ 1MΩ	1Ω ≤ R < 1MΩ ±200 ppm/°C	-- --
RC0603	1/10W		75V	150V	150V	E24 ±5% 1Ω ≤ R ≤ 22MΩ E24/E96 ±1% 1Ω ≤ R ≤ 10MΩ E24/E96 ±0.1%,±0.5% 10Ω ≤ R ≤ 1MΩ Jumper < 50mΩ	1Ω ≤ R ≤ 10Ω ±200 ppm/°C 10Ω < R ≤ 10MΩ ±100 ppm/°C 10MΩ < R ≤ 22MΩ ±200 ppm/°C	Rated current 1.0 Max. current 2.0
	1/5W		75V	150V	150V	E24 ±5% 1Ω ≤ R ≤ 1MΩ E24/E96 ±1% 1Ω ≤ R ≤ 1MΩ	1Ω ≤ R ≤ 1MΩ ±200 ppm/°C	-- --
RC0805	1/8W		150V	300V	300V	E24 ±5% 1Ω ≤ R ≤ 100MΩ E24/E96 ±1% 1Ω ≤ R ≤ 10MΩ E24/E96 ±0.1%,±0.5% 10Ω ≤ R ≤ 1MΩ E24 ±10%,20% 24MΩ ≤ R ≤ 100MΩ Jumper < 50mΩ	1Ω ≤ R ≤ 10Ω ±200 ppm/°C 10Ω < R ≤ 10MΩ ±100 ppm/°C 10MΩ < R ≤ 22MΩ ±200 ppm/°C 24MΩ ≤ R ≤ 100MΩ ±300 ppm/°C	Rated current 2.0 Max. current 5.0
	1/4W		150V	300V	300V	E24 ±5% 1Ω ≤ R ≤ 1MΩ E24/E96 ±1% 1Ω ≤ R ≤ 1MΩ	1Ω ≤ R ≤ 1MΩ ±200 ppm/°C	-- --
RC1206	1/4W		200V	400V	500V	E24 ±5% 1Ω ≤ R ≤ 100MΩ E24/E96 ±1% 1Ω ≤ R ≤ 10MΩ E24/E96 ±0.1%,±0.5% 10Ω ≤ R ≤ 1MΩ E24 ±10%,20% 24MΩ ≤ R ≤ 100MΩ Jumper < 50mΩ	1Ω ≤ R ≤ 10Ω ±200 ppm/°C 10Ω < R ≤ 10MΩ ±100 ppm/°C 10MΩ < R ≤ 22MΩ ±200 ppm/°C 24MΩ ≤ R ≤ 100MΩ ±300 ppm/°C	Rated current 2.0 Max. current 10.0
	1/2W		200V	400V	500V	E24 ±5% 1Ω ≤ R ≤ 1MΩ E24/E96 ±1% 1Ω ≤ R ≤ 1MΩ	1Ω ≤ R ≤ 1MΩ ±200 ppm/°C	-- --
RC1210	1/2W		200V	500V	500V	E24 ±5% 1Ω ≤ R ≤ 22MΩ E24/E96 ±1% 1Ω ≤ R ≤ 10MΩ E24/E96 ±0.1%,±0.5% 10Ω ≤ R ≤ 1MΩ Jumper < 50mΩ	1Ω ≤ R ≤ 10Ω ±200 ppm/°C 10Ω < R ≤ 10MΩ ±100 ppm/°C 10MΩ < R ≤ 22MΩ ±200 ppm/°C	Rated current 2.0 Max. current 10.0
RC1218	1W		200V	500V	500V	E24 ±5% 1Ω ≤ R ≤ 1MΩ E24/E96 ±1% 1Ω ≤ R ≤ 1MΩ E24/E96 ±0.1%,±0.5% 10Ω ≤ R ≤ 1MΩ Jumper < 50mΩ	1Ω ≤ R ≤ 10Ω ±200 ppm/°C 11Ω ≤ R ≤ 1MΩ ±100 ppm/°C	Rated current 6.0 Max. current 10.0
RC2010	3/4W	200V	500V	500V	E24 ±5% 1Ω ≤ R ≤ 22MΩ E24/E96 ±1% 1Ω ≤ R ≤ 10MΩ E24/E96 ±0.1%,±0.5% 10Ω ≤ R ≤ 1MΩ Jumper < 50mΩ	1Ω ≤ R ≤ 10Ω ±200 ppm/°C 10Ω < R ≤ 10MΩ ±100 ppm/°C 10MΩ < R ≤ 22MΩ ±200 ppm/°C	Rated current 2.0 Max. current 10.0	
RC2512	1W	200V	500V	500V	E24 ±5% 1Ω ≤ R ≤ 1MΩ E24/E96 ±1% 1Ω ≤ R ≤ 1MΩ E24/E96 ±0.1%,±0.5% 10Ω ≤ R ≤ 1MΩ Jumper < 50mΩ	1Ω ≤ R ≤ 10Ω ±200 ppm/°C 11Ω ≤ R ≤ 1MΩ ±100 ppm/°C	Rated current 2.0 Max. current 10.0	
	2W	200V	400V	500V	E24 ±5% 1Ω ≤ R ≤ 1MΩ E24/E96 ±1% 1Ω ≤ R ≤ 1MΩ	1Ω ≤ R ≤ 1MΩ ±200 ppm/°C	-- --	



Chip Resistors Selection Charts

RC - Thick film general purpose chip resistors, 0075 to 2512

Environmental characteristics				
Performance test	Test method	Procedure	Requirements	
Life	MIL-STD-202 -method 108A	1000 hours at 70 ±2°C applied RCWV 1.5 hours on, 0.5 hours off, still air required	0075: ± (5%+100mΩ) < 100mΩ for jumper 01005: ± (3% +50mΩ) < 100mΩ for jumper Others: ± (1% +50mΩ) for 0.1%/0.5%/1% tol. ± (3% +50mΩ) for 5% tol. < 100mΩ for jumper	
High temperature exposure	MIL-STD-202 -method 108A	1000 hours at maximum operating temperature depending on specification, unpowered	0075: ± (5%+100mΩ) < 100mΩ for jumper 01005: ± (1% +50mΩ) < 50mΩ for jumper Others: ± (1% +50mΩ) for 0.1%/0.5%/1% tol. ± (2% +50mΩ) for 5% tol. < 50mΩ for jumper	
Moisture resistance	MIL-STD-202 -method 106G	Each temperature / humidity cycle is defined as 8 hours (method 106G), 3 cycles / 24 hours for 10d with 25°C / 65°C 95% R.H	0075/ 01005: ± (2.0% +50mΩ) < 100mΩ for jumper Others: ± (0.5% +50mΩ) for 0.1%/0.5%/1% tol. ± (2% +50mΩ) for 5% tol. < 100mΩ for jumper	
Thermal shock	MIL-STD-202 -method 107G	-55 / +125°C Note: Number of cycles required is 300. Devices mounted Maximum transfer time is 20 seconds. Dwell time is 15 minutes. Air – Air	0075/ 01005: ± (1% +50mΩ) < 50mΩ for jumper Others: ± (0.5% +50mΩ) for 0.1%/0.5%/1% tol. ± (1% +50mΩ) for 5% tol. < 50mΩ for jumper	
Solderability	Wetting	J-STD-002B test B	Electrical test not required. Magnification 50X Lead-free solder bath at 245 ±3°C Dipping time: 3 ±0.5 seconds	Well tinned (≥ 95% covered) No visible damage
	Resistance to soldering heat	MIL-STD-202 -method 210F	Lead-free solder, 260°C, 10 seconds immersion time	0075/ 01005: ± (1% +50mΩ) < 50mΩ for jumper Others: ± (0.5% +50mΩ) for 0.1%/0.5%/1% tol. ± (1% +0.05 Ω) for 5% tol. < 50mΩ for jumper No visible damage
Short time overload	IEC 60115 -1 4.13	2.5 times RCWV or maximum overload voltage whichever is less for 5 seconds at room temperature	0075/ 01005: ± (2% +50mΩ) < 50mΩ for jumper Others: ± (1% +50mΩ) for 0.1%/0.5%/1% tol. ± (2% +50mΩ) for 5% tol. < 50mΩ for jumper No visible damage	



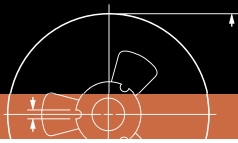

Chip Resistors Selection Charts

RC - Thick film general purpose chip resistors, 0075 to 2512

Global part number - Preferred type for ordering Yageo / Phycomp branded products

Ordering example: RC0402JR-07100KL

<p>RC 0402 J R — 07 100 K L</p> <p>Series name (code 1-2) _____ RC = General purpose thick film</p> <p>Size code (code 3-6) _____ (inch / metric) 0075 = 0.3 x 0.1 0100 = 0.4 x 0.2 0201 = 0.6 x 0.3 0402 = 1.0 x 0.5 0603 = 1.6 x 0.8 0805 = 2.0 x 1.25 1206 = 3.2 x 1.6 1210 = 3.2 x 2.6 1218 = 3.2 x 4.5 2010 = 5.0 x 2.5 2512 = 6.35 x 3.2</p> <p>Tolerance (code 7) _____ B = ±0.1% D = ±0.5% F = ±1% J = ±5% (for Jumper ordering)</p>	<p>_____ Default code^(1/2) (code 17)</p> <p>_____ Resistance (code 12-16) 0R = Jumper 10R = 10Ω 100R = 100Ω 100K = 100KΩ</p> <p>_____ Taping reel (code 10-11) 07 = 7 inch Dia. reel 10 = 10 inch Dia. reel 13 = 13 inch Dia. reel 7N = 7 inch Dia. reel, ESD safe reel (0075/0100 only) 7W = 7 inch Dia. reel, 2 x standard power 3W = 13 inch Dia. reel, 2 x standard power</p> <p>_____ T. C. R. (code 9) "—" = Based on spec. (— for thick film only)</p> <p>_____ Packing style (code 8) R = Paper tape reel K = Embossed plastic tape reel S = ESD safe reel (0075/0100 only)</p>
--	---

Note: 1. All of our RSMD products are RoHS compliant. "LFP" of the internal 2D reel label mentions "Lead Free Process"
 2. Letter L is system default code for ordering only



Chip Resistors Selection Charts

RC - Thick film general purpose chip resistors, 0075 to 2512

Phycomp worldwide - Traditional type										
General purpose thick film / RC series										
Size: inch (mm)	0201 (0603)		0402 (1005)		0603 (1608)		0805 (2012)			
Power	1/20 W		1/16 W		1/10 W		1/8 W			
Tolerance	+5%	+1%	+5%	+1%	+5%	+1%	+5%	+1%	+1%	
Resistance	E24	E24 / E96	E24	E24 / E96	E24	E24 / E96	E24	E24 / E96	E24 / E96	
Packing	paper tape		paper tape		paper tape		paper tape			
Quantity	5 000	---	---	---	---	---	2322 702 60...L	2322 704 6...L	2322 730 61...L	2322 734 6...L
	10 000	2322 803 70...L	2322 806 7...L	2322 705 70...L	2322 706 7...L	2322 702 70...L	2322 704 7...L	2322 730 71...L	2322 734 7...L	
	20 000	2322 806 80...L	2322 806 8...L	---	---	2322 702 81...L	2322 704 8...L	2322 730 81...L	2322 734 8...L	
	50 000	2322 803 60...L	2322 806 6...L	2322 705 87...L	2322 706 8...L	---	---	---	---	
Jumper	5 000	---	---	---	---	---	2322 702 96001L	---	2322 730 91002L	---
	10 000	2322 803 91001L	---	2322 705 91001L	---	2322 702 97001L	---	2322 730 91003L	---	
	20 000	---	---	---	---	2322 702 92002L	---	2322 730 92002L	---	
	50 000	---	---	2322 705 91007L	---	---	---	---	---	

For ordering rules: See page 14 for E24 / E96 values and the last 4 or 3 digits of the 12NC catalogue number

Phycomp worldwide - Traditional type												
General purpose thick film / RC series												
Size: inch (mm)	1206 (3216)		1210 (3225)		1218 (3248)		2010 (5025)		2512 (6432)			
Power	1/4 W		1/2 W		1 W		3/4 W		1 W			
Tolerance	+5%	+1%	+5%	+1%	+5%	+1%	+5%	+1%	+5%	+1%		
Resistance	E24	E24 / E96	E24	E24 / E96	E24	E24 / E96	E24	E24 / E96	E24	E24 / E96		
Packing	paper tape		paper tape		blister tape		blister tape		blister tape			
Quantity	4 000	---	---	---	---	---	2322 735 64...L	2322 735 7...L	2322 760 60...L	2322 761 6...L	2322 762 60...L	2322 763 6...L
	5 000	2322 711 61...L	2322 724 6...L	2390 735 70...L	2390 735 3...L	---	---	---	---	---	---	
	10 000	2322 711 51...L	2322 724 7...L	---	---	---	---	---	---	---	---	
	20 000	2322 711 81...L	2322 724 8...L	2390 735 71...L	2390 735 5...L	---	---	---	---	---	---	
Jumper	4 000	---	---	---	---	---	2322 735 90007L	---	2322 760 90003L	---	2322 762 90000L	---
	5 000	2322 711 91032L	---	2390 735 90001L	---	---	---	---	---	---	---	
	10 000	2322 711 91005L	---	---	---	---	---	---	---	---	---	
	20 000	2322 711 92004L	---	---	---	---	---	---	---	---	---	

For ordering rules: See page 14 for E24 / E96 values and the last 4 or 3 digits of the 12NC catalogue number

Phycomp CTC ordering code - Traditional type - North America
Regional code for ordering Phycomp branded products. Please see page 17 for details.

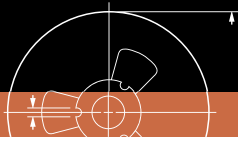

Chip Resistors Selection Charts

RC_P - Total lead free thick film general purpose chip resistor, 0201 to 2512

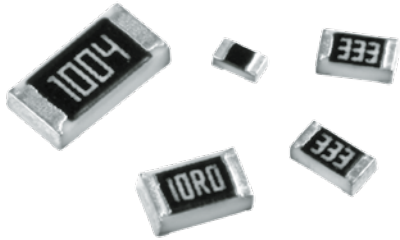

Features

- Highly reliable electrode construction
- Compatible with all soldering processes
- Highly stable in auto-placement surface mounting applications
- Barrier layer end termination
- Lead free (Pb<100ppm) without RoHS exemptions (7C-1)

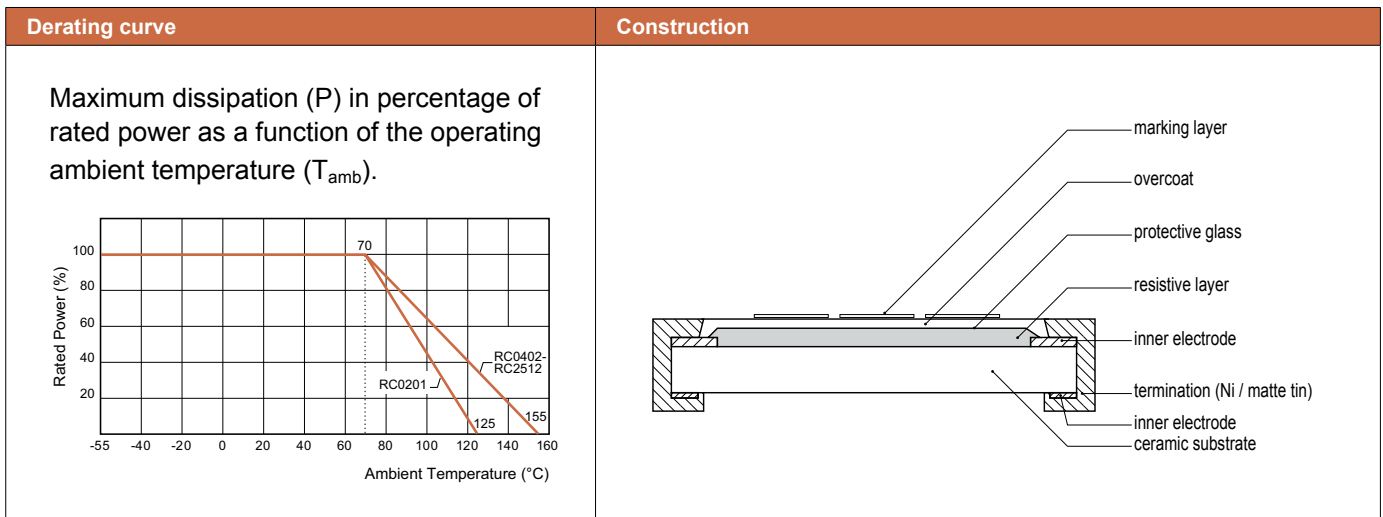

Dimensions	Type	L	W	H	l_1	l_2
<p>unit: mm</p>	RC0201	0.60 ± 0.03	0.30 ± 0.03	0.23 ± 0.03	0.10 ± 0.05	0.15 ± 0.05
	RC0402	1.00 ± 0.05	0.50 ± 0.05	0.32 ± 0.05	0.20 ± 0.10	0.25 ± 0.10
	RC0603	1.60 ± 0.10	0.80 ± 0.10	0.45 ± 0.10	0.25 ± 0.15	0.25 ± 0.15
	RC0805	2.00 ± 0.10	1.25 ± 0.10	0.50 ± 0.10	0.35 ± 0.20	0.35 ± 0.20
	RC1206	3.10 ± 0.10	1.60 ± 0.10	0.55 ± 0.10	0.45 ± 0.20	0.40 ± 0.20
	RC1210	3.10 ± 0.10	2.60 ± 0.15	0.55 ± 0.10	0.45 ± 0.15	0.50 ± 0.20
	RC1218	3.10 ± 0.10	4.60 ± 0.10	0.55 ± 0.10	0.45 ± 0.20	0.40 ± 0.20
	RC2010	5.00 ± 0.10	2.50 ± 0.15	0.55 ± 0.10	0.45 ± 0.15	0.50 ± 0.20
	RC2512	6.35 ± 0.10	3.10 ± 0.15	0.55 ± 0.10	0.60 ± 0.20	0.50 ± 0.20

Chip Resistors Selection Charts

RC_P - Total lead free thick film general purpose chip resistor, 0201 to 2512

Electrical characteristics								
Type	Power P ₇₀	Operating Temp. range	MWV	RCOV	DWV	Resistance range & tolerance	T. C. R.	Jumper criteria (unit: A)
RC0201	1/20W	-55°C to +125°C	25V	50V	50V	E24 ±5% 1Ω ≤ R ≤ 10MΩ E24/E96 ±1% 1Ω ≤ R ≤ 10MΩ E24/E96 ±0.5% 10Ω ≤ R ≤ 1MΩ Jumper < 50mΩ	1Ω ≤ R ≤ 10Ω -100/ ±500 ppm/°C 10Ω < R ≤ 100Ω ±300 ppm/°C 100Ω < R ≤ 10MΩ ±200 ppm/°C	Rated current 0.5 Max. current 1.0
RC0402	1/16W	-55°C to +155°C	50V	100V	100V	E24 ±5% 1Ω ≤ R ≤ 22MΩ E24/E96 ±1% 1Ω ≤ R ≤ 10MΩ E24/E96 ±0.5% 10Ω ≤ R ≤ 1MΩ Jumper < 50mΩ	1Ω ≤ R ≤ 10Ω ±350 ppm/°C 10Ω < R ≤ 100Ω ±200 ppm/°C 100Ω < R ≤ 10MΩ ±150 ppm/°C 10MΩ < R ≤ 22MΩ ±200 ppm/°C	Rated current 1.0 Max. current 2.0
RC0603	1/10W		75V	150V	150V	E24 ±5% 1Ω ≤ R ≤ 22MΩ E24/E96 ±1% 1Ω ≤ R ≤ 10MΩ E24/E96 ±0.5% 10Ω ≤ R ≤ 1MΩ Jumper < 50mΩ	1Ω ≤ R ≤ 10Ω ±300 ppm/°C 10Ω < R ≤ 100Ω ±200 ppm/°C 100Ω < R ≤ 10MΩ ±150 ppm/°C 10MΩ < R ≤ 22MΩ ±200 ppm/°C	Rated current 1.0 Max. current 2.0
RC0805	1/8W		150V	300V	300V	E24 ±5% 1Ω ≤ R ≤ 22MΩ E24/E96 ±1% 1Ω ≤ R ≤ 10MΩ E24/E96 ±0.5% 10Ω ≤ R ≤ 1MΩ Jumper < 50mΩ	1Ω ≤ R ≤ 10Ω ±300 ppm/°C 10Ω < R ≤ 100Ω ±150 ppm/°C 100Ω < R ≤ 10MΩ ±100 ppm/°C 10MΩ < R ≤ 22MΩ ±200 ppm/°C	Rated current 2.0 Max. current 5.0
RC1206	1/4W		200V	400V	500V	E24 ±5% 1Ω ≤ R ≤ 22MΩ E24/E96 ±1% 1Ω ≤ R ≤ 10MΩ E24/E96 ±0.5% 10Ω ≤ R ≤ 1MΩ Jumper < 50mΩ	1Ω ≤ R ≤ 10Ω ±300 ppm/°C 10Ω < R ≤ 100Ω ±100 ppm/°C 100Ω < R ≤ 10MΩ ±100 ppm/°C 10MΩ < R ≤ 22MΩ ±200 ppm/°C	Rated current 2.0 Max. current 10.0
RC1210	1/2W		200V	500V	500V	E24 ±5% 1Ω ≤ R ≤ 22MΩ E24/E96 ±1% 1Ω ≤ R ≤ 10MΩ E24/E96 ±0.5% 10Ω ≤ R ≤ 1MΩ Jumper < 50mΩ	1Ω ≤ R ≤ 10Ω ±300 ppm/°C 10Ω < R ≤ 100Ω ±100 ppm/°C 100Ω < R ≤ 10MΩ ±100 ppm/°C 10MΩ < R ≤ 22MΩ ±200 ppm/°C	Rated current 2.0 Max. current 10.0
RC1218	1W		200V	500V	500V	E24 ±5% 1Ω ≤ R ≤ 1MΩ E24/E96 ±1% 1Ω ≤ R ≤ 1MΩ E24/E96 ±0.5% 10Ω ≤ R ≤ 1MΩ Jumper < 50mΩ		Rated current 6.0 Max. current 10.0
RC2010	3/4W		200V	500V	500V	E24 ±5% 1Ω ≤ R ≤ 22MΩ E24/E96 ±1% 1Ω ≤ R ≤ 10MΩ E24/E96 ±0.5% 10Ω ≤ R ≤ 1MΩ Jumper < 50mΩ		Rated current 2.0 Max. current 10.0
RC2512	1W		200V	500V	500V	E24 ±5% 1Ω ≤ R ≤ 22MΩ E24/E96 ±1% 1Ω ≤ R ≤ 10MΩ E24/E96 ±0.5% 10Ω ≤ R ≤ 1MΩ Jumper < 50mΩ		Rated current 2.0 Max. current 10.0

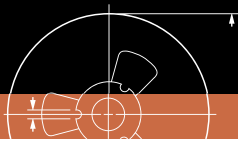

Chip Resistors Selection Charts

RC_P - Total lead free thick film general purpose chip resistor, 0201 to 2512

Environmental characteristics				
Performance test		Test method	Procedure	Requirements
Life		MIL-STD-202 -method 108A	1000 hours at 70 ±2°C applied RCWV 1.5 hours on, 0.5 hours off, still air required	± (1% +50mΩ) for 0.5%/1% tol. ± (3% +50mΩ) for 5% tol. < 100mΩ for jumper
High temperature exposure		MIL-STD-202 -method 108A	1000 hours at maximum operating temperature depending on specification, unpowered	± (1% +50mΩ) for 0.5%/1% tol. ± (2% +50mΩ) for 5% tol. < 50mΩ for jumper
Moisture resistance		MIL-STD-202 -method 106G	Each temperature / humidity cycle is defined as 8 hours (method 106G), 3 cycles / 24 hours for 10d with 25°C / 65°C 95% R.H	± (0.5% +50mΩ) for 0.5%/1% tol. ± (2% +50mΩ) for 5% tol. < 100mΩ for jumper
Thermal shock		MIL-STD-202 -method 107G	-55 / +125°C Note: Number of cycles required is 300. Devices mounted Maximum transfer time is 20 seconds. Dwell time is 15 minutes. Air – Air	± (0.5% +50mΩ) for 0.5%/1% tol. ± (1% +50mΩ) for 5% tol. < 50mΩ for jumper
Solderability	Wetting	J-STD-002B test B	Electrical test not required. Magnification 50X Lead-free solder bath at 245 ±3°C Dipping time: 3 ±0.5 seconds	Well tinned (≥ 95% covered) No visible damage
	Resistance to soldering heat	MIL-STD-202 -method 210F	Lead-free solder, 260°C, 10 seconds immersion time	± (0.5% +50mΩ) for 0.5%/1% tol. ± (1% +0.05 Ω) for 5% tol. < 50mΩ for jumper No visible damage
Short time overload		IEC 60115 -1 4.13	2.5 times RCWV or maximum overload voltage whichever is less for 5 seconds at room temperature	± (1% +50mΩ) for 0.5%/1% tol. ± (2% +50mΩ) for 5% tol. < 50mΩ for jumper No visible damage

Global part number - Preferred type for ordering Yageo / Phycomp branded products

Ordering example: RC0402JR-07100KP

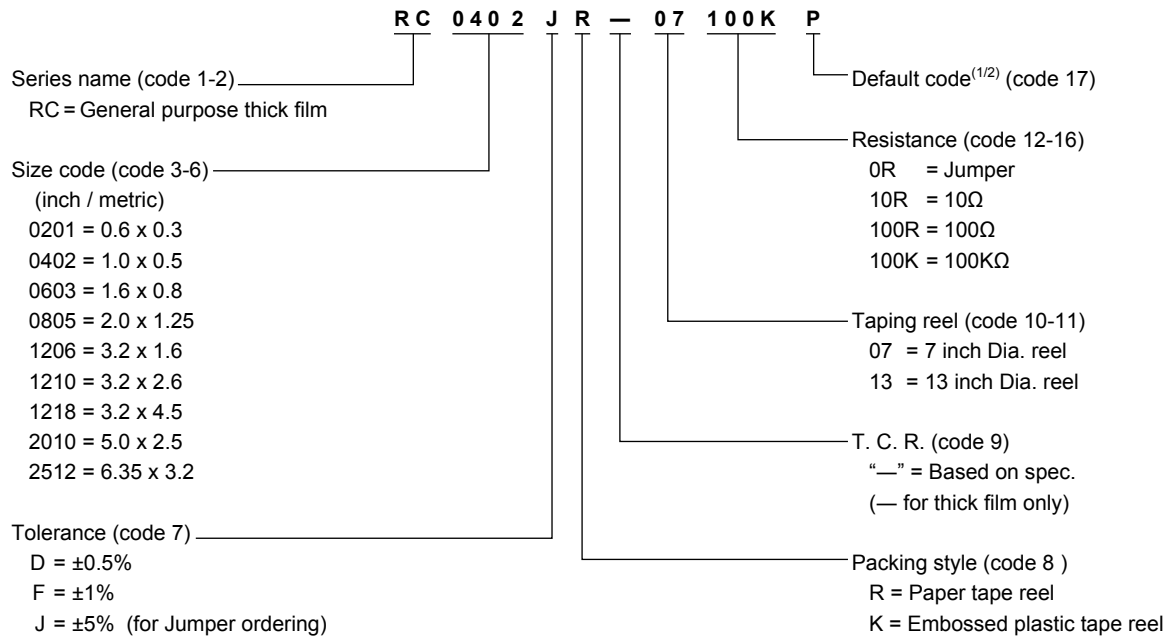

Note: 1. All of our RSMD products are RoHS compliant. "LFP" of the internal 2D reel label mentions "Lead Free Process"
2. Letter L is system default code for ordering only



Chip Resistors Selection Charts

RE - Thick film precision grade chip resistors, 0201 to 1206



Features

- Narrow tolerance
- Low T. C. R.
- Highly reliable construction
- Compatible with all soldering processes
- Suitable for auto-placement surface mounting applications
- Available in 8mm tape & reel per EIA RS481

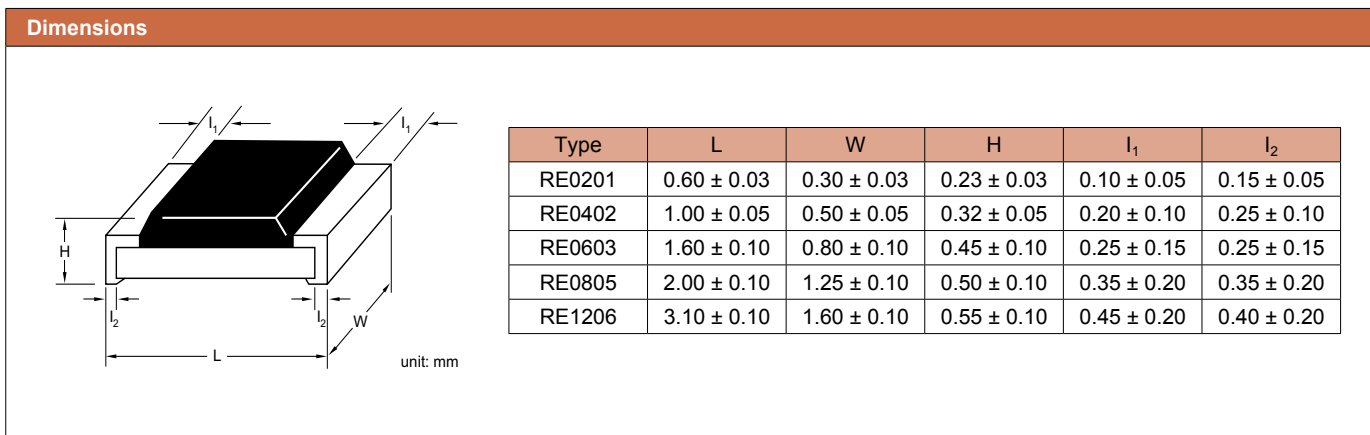
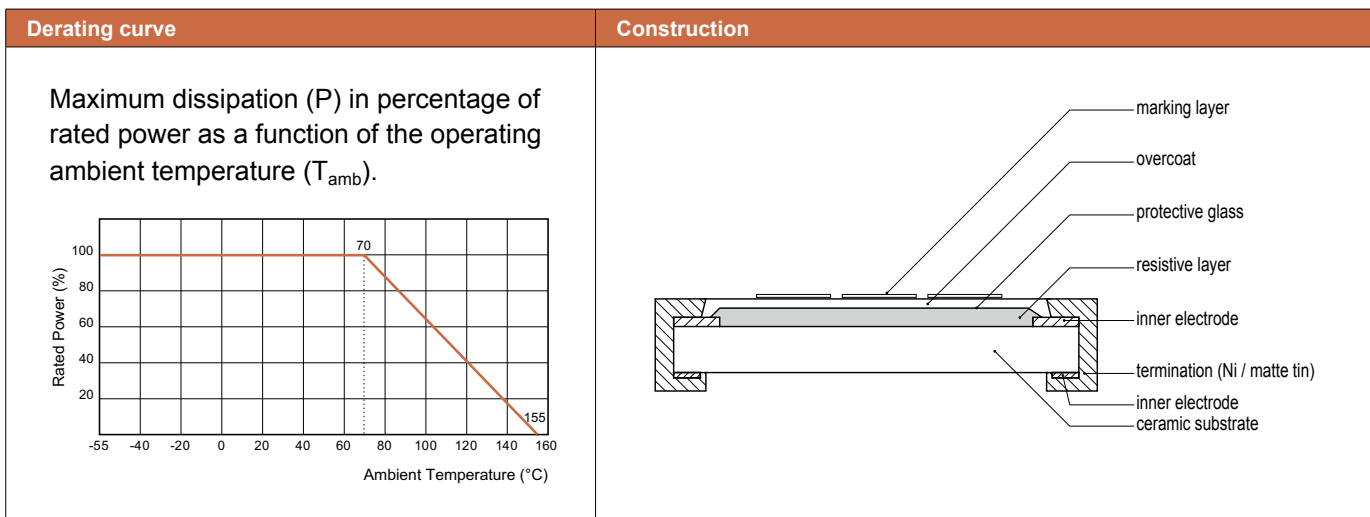

Electrical characteristics							
Type	Power P_{70}	Operating Temp. range	MWV	RCOV	DWV	Resistance range & tolerance	T. C. R.
RE0201	1/20W	-55°C to +155°C	25V	50V	50V	E24/E96 $\pm 0.1\%, \pm 0.5\%, \pm 1\%$ $100\Omega \leq R \leq 1M\Omega$	$\pm 50 \text{ ppm}/^\circ\text{C}$
RE0402	1/16W		50V	100V	100V	E24/E96 $\pm 0.1\%, \pm 0.5\%, \pm 1\%$ $10\Omega \leq R \leq 1M\Omega$	
RE0603	1/10W		75V	150V	150V		
RE0805	1/8W		150V	300V	300V		
RE1206	1/4W		200V	400V	500V		



Chip Resistors Selection Charts

RE - Thick film precision grade chip resistors, 0201 to 1206

Environmental characteristics				
Performance test	Test method	Procedure	Requirements	
Life	MIL-STD-202 -method 108A	1000 hours at 70 ±2°C applied RCWV 1.5 hours on, 0.5 hours off, still air required	± (3% +50mΩ)	
High temperature exposure	MIL-STD-202 -method 108A	1000 hours at maximum operating temperature depending on specification, unpowered	± (3% +50mΩ)	
Moisture resistance	MIL-STD-202 -method 106G	Each temperature / humidity cycle is defined as 8 hours (method 106G), 3 cycles / 24 hours for 10d with 25°C / 65°C 95% R.H	± (3% +50mΩ)	
Thermal shock	MIL-STD-202 -method 107G	-55 / +125°C Note: Number of cycles required is 300. Devices mounted Maximum transfer time is 20 seconds. Dwell time is 15 minutes. Air – Air	± (1% +50mΩ)	
Solderability	Wetting	IPC/JEDECJ- STD-002B test B	Electrical test not required. Magnification 50X Lead-free solder bath at 245 ±3°C Dipping time: 3 ±0.5 seconds	Well tinned (≥ 95% covered) No visible damage
	Resistance to soldering heat	MIL-STD-202 -method 210F	Lead-free solder, 260°C, 10 seconds immersion time	± (0.5%+ 50mΩ) No visible damage
Short time overload	IEC 60115 -1 4.13	2.5 times RCWV or maximum overload voltage whichever is less for 5 seconds at room temperature	± (1%+ 50mΩ) No visible damage	

Global part number - Preferred type for ordering Yageo / Phycomp branded products

Ordering example: RE0603DRE07100KL

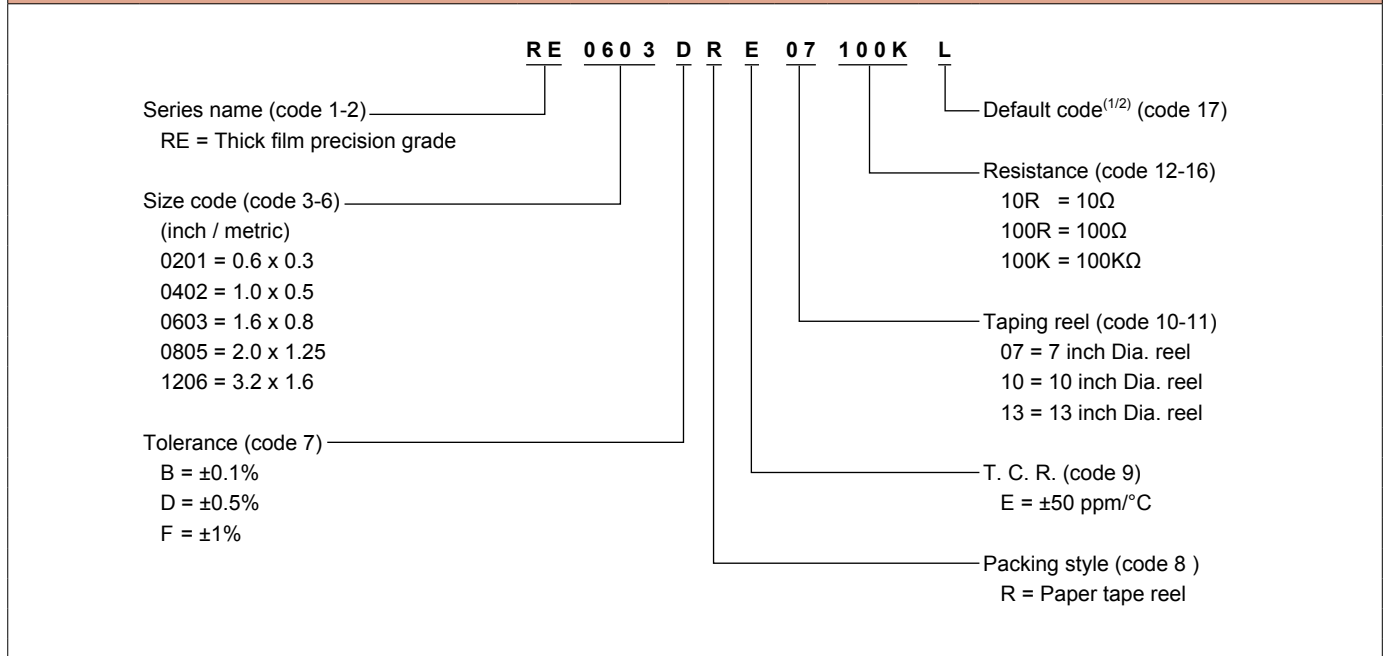

- Note:** 1. All of our RSMD products are RoHS compliant. "LFP" of the internal 2D reel label mentions "Lead Free Process"
2. Letter L is system default code for ordering only
3. RE series products are available by "Global part number" only



Chip Resistors Selection Charts

YC/TC - Thick film array / network chip resistors

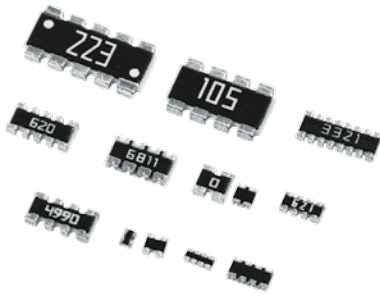

Features

- Integrated discrete chip resistors from 2 to 8 pcs
- More efficient in pick & place application
- Low assembly costs
- Reduced size of final equipment
- Higher component and equipment reliability

Schematics

YC102/122/162⁽¹⁾

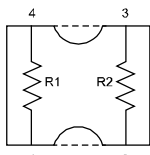

$$R1 = R2$$

YC104/124/164/324⁽¹⁾

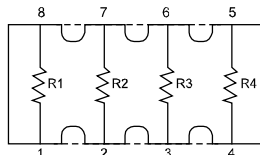

$$R1 = R2 = R3 = R4$$

YC248

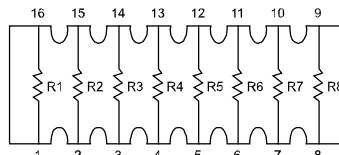

$$R1 = R2 = R3 = R4 = R5 = R6 = R7 = R8$$

YC358 (L-Type)

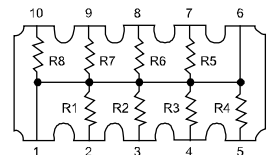

$$R1 = R2 = R3 = R4 = R5 = R6 = R7 = R8$$

TC122

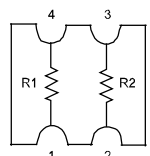

$$R1 = R2$$

TC124/164

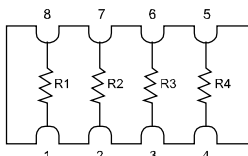

$$R1 = R2 = R3 = R4$$

YC158

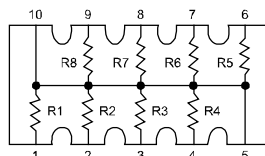

$$R1 = R2 = R3 = R4 = R5 = R6 = R7 = R8$$

YC358 (T-Type)

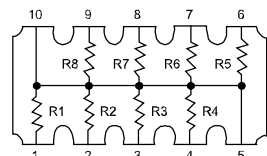

$$R1 = R2 = R3 = R4 = R5 = R6 = R7 = R8$$

Dimensions

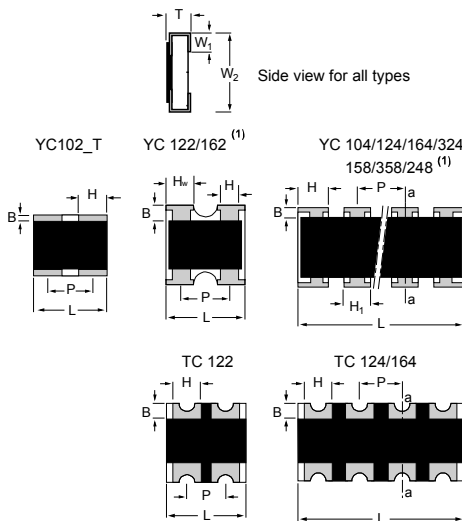

Note: 1. YC102/104 are flat type

Type	H / H _i /H _w	B	P	L	T	W ₁	W ₂
YC102	H: 0.30 ± 0.10	0.15 ± 0.10	0.55 ± 0.10	0.80 ± 0.10	0.35 ± 0.10	0.15 ± 0.10	0.60 ± 0.10
YC104	H: 0.20 ± 0.10	0.15 ± 0.05	0.40 ± 0.10	1.40 ± 0.10	0.35 ± 0.10	0.15 ± 0.10	0.60 ± 0.10
YC122	H _w : 0.35 ± 0.10 H: 0.21 +0.10 /-0.05	0.20 ± 0.10	0.67 ± 0.05	1.00 ± 0.10	0.30 ± 0.10	0.25 ± 0.10	1.00 ± 0.10
YC124	H: 0.45 ± 0.05 H _i : 0.30 ± 0.05	0.20 ± 0.15	0.50 ± 0.05	2.00 ± 0.10	0.45 ± 0.10	0.30 ± 0.15	1.00 ± 0.10
YC162	H _w : 0.65 ± 0.15 H: 0.30 ± 0.10	0.30 ± 0.10	0.80 ± 0.05	1.60 ± 0.10	0.40 ± 0.10	0.30 ± 0.10	1.60 ± 0.10
YC164	H: 0.65 ± 0.05 H _i : 0.50 ± 0.15	0.30 ± 0.15	0.80 ± 0.05	3.20 ± 0.15	0.60 ± 0.10	0.30 ± 0.15	1.60 ± 0.15
YC248	H: 0.45 ± 0.05 H _i : 0.30 ± 0.05	0.30 ± 0.15	0.50 ± 0.05	4.00 ± 0.20	0.45 ± 0.10	0.40 ± 0.15	1.60 ± 0.15
YC324	H: 1.10 ± 0.15 H _i : 0.90 ± 0.15	0.50 ± 0.20	1.27 ± 0.05	5.08 ± 0.20	0.60 ± 0.10	0.50 ± 0.15	3.20 ± 0.20
TC122	H: 0.30 ± 0.05	0.25 ± 0.15	0.50 ± 0.05	1.00 ± 0.10	0.30 ± 0.10	0.25 ± 0.15	1.00 ± 0.10
TC124	H: 0.30 ± 0.10	0.20 ± 0.10	0.50 ± 0.05	2.00 ± 0.10	0.40 ± 0.10	0.25 ± 0.10	1.00 ± 0.10
TC164	H: 0.60 ± 0.15	0.30 ± 0.15	0.80 ± 0.05	3.20 ± 0.15	0.60 ± 0.10	0.30 ± 0.15	1.60 ± 0.15
YC158T	H: 0.45 ± 0.05 H _i : 0.32 ± 0.05	0.30 ± 0.15	0.64 ± 0.05	3.20 ± 0.20	0.60 ± 0.10	0.35 ± 0.15	1.60 ± 0.15
YC358L YC358T	H: 1.10 ± 0.15 H _i : 0.90 ± 0.15	0.50 ± 0.15	1.27 ± 0.05	6.40 ± 0.20	0.60 ± 0.10	0.50 ± 0.15	3.20 ± 0.20



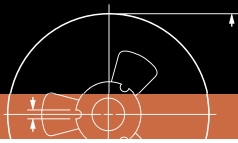

Chip Resistors Selection Charts

YC/TC - Thick film array / network chip resistors

Electrical characteristics								
Type	Power P ₇₀	Operating Temp. range	MWV	RCOV	DWV	Resistance range & tolerance	T. C. R.	Jumper criteria (unit: A)
YC102	1/32W	-55°C to +125°C	15V	30V	30V	E24 ±5% 10Ω ≤ R ≤ 1MΩ E24/E96 ±1% 10Ω ≤ R ≤ 1MΩ Jumper < 50mΩ	±200 ppm/°C	Rated current 0.5 Max. current 1.0
YC104	1/32W		12.5V	25V	25V	E24 ±5% 10Ω ≤ R ≤ 1MΩ E24/E96 ±1% 10Ω ≤ R ≤ 1MΩ Jumper < 50mΩ		Rated current 0.5 Max. current 1.0
YC122	1/16W	-55°C to +155°C	50V	100V	100V	E24 ±5% 1Ω ≤ R ≤ 1MΩ E24/E96 ±1% 1Ω ≤ R ≤ 1MΩ Jumper < 50mΩ	1Ω ≤ R ≤ 10Ω ±250 ppm/°C 10Ω ≤ R ≤ 1MΩ ±200 ppm/°C	Rated current 0.5 Max. current 1.0
YC124	1/16W		25V	50V	100V	E24 ±5% 1Ω ≤ R ≤ 1MΩ E24/E96 ±1% 1Ω ≤ R ≤ 1MΩ Jumper < 50mΩ		Rated current 1.0 Max. current 2.0
YC162	1/16W		50V	100V	100V	E24/E96 ±1% 1Ω ≤ R ≤ 1MΩ E24 ±5% 1Ω ≤ R ≤ 1MΩ Jumper < 50mΩ		Rated current 1.0 Max. current 2.0
YC164	1/16W		50V	100V	100V	E24 ±5% 1Ω ≤ R ≤ 1MΩ E24/E96 ±1% 1Ω ≤ R ≤ 1MΩ Jumper < 50mΩ	±200 ppm/°C	Rated current 1.0 Max. current 2.0
YC248	1/16W		50V	100V	100V	E24 ±5% 10Ω ≤ R ≤ 1MΩ E24/E96 ±1% 10Ω ≤ R ≤ 1MΩ Jumper < 50mΩ		Rated current 2.0 Max. current 10.0
YC324	1/8W		200V	500V	500V	E24 ±5% 10Ω ≤ R ≤ 1MΩ E24/E96 ±1% 10Ω ≤ R ≤ 1MΩ Jumper < 50mΩ		Rated current 2.0 Max. current 10.0
TC122	1/16W		50V	100V	100V	E24 ±5% 10Ω ≤ R ≤ 1MΩ E24/E96 ±1% 10Ω ≤ R ≤ 1MΩ Jumper < 50mΩ		Rated current 1.0 Max. current 1.5
TC124	1/16W		50V	100V	100V	E24 ±5% 10Ω ≤ R ≤ 1MΩ E24/E96 ±1% 10Ω ≤ R ≤ 1MΩ Jumper < 50mΩ	Rated current 1.0 Max. current 1.5	
TC164	1/16W		50V	100V	100V	E24 ±5% 10Ω ≤ R ≤ 1MΩ E24/E96 ±1% 10Ω ≤ R ≤ 1MΩ Jumper < 50mΩ	Rated current 1.0 Max. current 2.0	
YC158T	1/16W		25V	50V	50V	E24 ±5% 10Ω ≤ R ≤ 100KΩ	--	--
YC358T YC358L	1/16W	50V	100V	100V	E24 ±5% 10Ω ≤ R ≤ 330KΩ	--	--	

Environmental characteristics			
Performance test	Test method	Procedure	Requirements
Life	MIL-STD-202 Method 108A	1000 hours at 70 ±2°C applied RCWV 1.5 hours on, 0.5 hours off, still air required	± (2% +50mΩ) < 100mΩ for jumper
High temperature exposure	MIL-STD-202 Method 108A	1000 hours at maximum operating temperature depending on specification, unpowered	± (1% +50mΩ) < 50mΩ for jumper
Moisture resistance	MIL-STD-202 Method 106G	Each temperature / humidity cycle is defined as 8 hours(method 106G), 3 cycles / 24 hours for 10d with 25°C / 65°C 95% R.H	± (2% +50mΩ) < 100mΩ for jumper
Thermal shock	MIL-STD-202 Method 107G	-55 / +125°C Note: Number of cycles required is 300. Devices mounted Maximum transfer time is 20 seconds. Dwell time is 15 minutes. Air – Air	± (1% +50mΩ) for others < 50mΩ for jumper
Solderability	Wetting	J-STD-002B test B Electrical test not required. Magnification 50X Lead-free solder bath at 245 ±3°C Dipping time: 3 ±0.5 seconds	Well tinned (≥ 95% covered)
	Resistance to soldering heat	MIL-STD-202 method 210F Lead-free solder, 260°C, 10 seconds immersion time	± (1% +50mΩ) < 50mΩ for jumper No visible damage
Short time overload	IEC 60115 -1 4.13	2.5 times RCWV or maximum overload voltage whichever is less for 5 seconds at room temperature	± (2% +50mΩ) < 50mΩ for jumper No visible damage



Chip Resistors Selection Charts

YC/TC - Arrays, convex / concave / flat

Global part number - Arrays

Ordering example: YC122-JR-07100KL

Y C 1 2 2 - J R - 0 7 1 0 0 K L/T

Series name (code 1-2) ————

YC = Array & Network
(convex / flat) thick film
TC = Array (concave) thick film

Size code (inch) (code 3-4) ————

10 = 0201 x 2 (0202)
0201 x 4 (0204)
12 = 0402 x 2 (0404)
0402 x 4 (0408)
16 = 0603 x 2 (0606)
0603 x 4 (0612)
24 = 0602 x 8 (0616)
32 = 1206 x 4 (1224)

Number of resistors (code 5) ————

2 = 2 resistors
4 = 4 resistors
8 = 8 resistors

Default code (code 17)
T = The only code for YC102

Resistance (code 12-16)
0R = Jumper
10R = 10Ω
100R = 100Ω
100K = 100KΩ

Taping reel (code 10-11)
07 = 7 inch Dia. reel
13 = 13 inch Dia. reel

T. C. R. (code 9)
"—" = Based on spec.

Packing style (code 8)
R = Paper tape reel
K = Embossed plastic tape reel

Tolerance (code 7)
F = ±1%
J = ±5% (for Jumper ordering)

Note: 1. All of our RSMD products are RoHS compliant. "LFP" of the internal 2D reel label mentions "Lead Free Process"
2. Letter L is system default code for ordering only

Phycomp worldwide - Traditional type												
Array thick film chip resistors												
Size: inch / mm	2 X 0402 / 1 X 1		4 X 0402 / 2 X 1		8 X 0602 / 4.0 X 1.6		4 X 0603 / 3.2 X 1.3				4 X 1206 / 5.2 X 3.1	
Power	1/16 W		1/16 W		1/16 W		1/16 W				1/8 W	
Tolerance	+5%	+1%	+5%	+1%	+5%	+1%	+5%	+1%	+5%	+1%	+5%	
Type	R-array / R-network (convex)	R-array / R-network (convex)	R-array / R-network (convex)	R-array / R-network (convex)	R-array / R-network (convex)	R-array / R-network (convex)	R-array / R-network (convex)	R-array / R-network (convex)	R-array / R-network (convex)	R-array / R-network (convex)	R-array / R-network (convex)	R-array / R-network (convex)
Resistance	E24	E24 / E96	E24	E24 / E96	E24	E24 / E96	E24	E24 / E96	E24	E24/E96	E24	
Packing	paper tape		paper tape		paper tape		paper tape				blister tape	
Quantity	4 000	---	---	---	---	---	---	---	---	---	---	2350 039 10...L
	5 000	---	---	---	---	2350 053 10...L	2350 043 1...L	2350 035 10...L	2350 025 1...L	2350 034 10...L	2350 024 1...L	---
	10 000	2350 013 11...L	2350 013 2...L	2350 033 11...L	2350 023 2...L	---	---	---	---	---	---	---
Jumper	5 000	---	---	---	---	2350 053 91001L	---	2350 035 91001L	---	2350 034 91001L	---	---
	10 000	2350 013 91001L	---	2350 033 91001L	---	---	---	---	---	---	---	---

For ordering rules: See page 14 for E24 / E96 values and the last 4 or 3 digits of the 12NC catalogue number

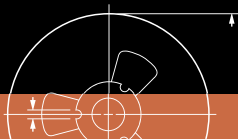

Chip Resistors Selection Charts

YC/TC - Network, T-type / L-type

Global part number - Networks

Ordering example: YC158TJR-07100KL

Y C 1 5 8 T J R - 0 7 1 0 0 K L

<p>Series name (code 1-2) ————</p> <p>YC = Array & Network (convex) thick film</p> <p>Size code (inch) (code 3-4) ————</p> <p>15 = 10Pin/8R (0612)</p> <p>35 = 10Pin/8R (1225)</p> <p>Number of resistors (code 5) ————</p> <p>8 = 8 resistors</p> <p>Schematic (code 6) ————</p> <p>L = L-type (for YC358)</p> <p>T = T-type (for YC158/358)</p>	<p>Default code (code 17)</p> <p>Resistance (code 12-16)</p> <p>0R = Jumper</p> <p>10R = 10Ω</p> <p>100R = 100Ω</p> <p>100K = 100KΩ</p> <p>Taping reel (code 10-11)</p> <p>07 = 7 inch Dia. reel</p> <p>13 = 13 inch Dia. reel</p> <p>T. C. R. (code 9)</p> <p>“—” = Based on spec.</p> <p>Packing style (code 8)</p> <p>R = Paper tape reel</p> <p>K = Embossed plastic tape reel</p> <p>Tolerance (code 7)</p> <p>J = ±5%</p>
---	--

Note: 1. All of our RSMD products are RoHS compliant. "LFP" of the internal 2D reel label mentions "Lead Free Process"
 2. Letter L is system default code for ordering only

Phycomp worldwide - Traditional type			
Network thick film chip resistors			
Size: inch (mm)	0612 (1632)		1225 (3264)
Power	1/16 W		1/16 W
Tolerance	+5%		+5%
Type	T-type 10 Pin / 8R PIN 5 and PIN 10 no resistance	T-type 10 Pin / 8R PIN 5 and PIN 10 no resistance	L-type 10 Pin / 8R PIN 1 and PIN 6 no resistance
Resistance	E24		E24
Packing	paper tape		blister tape
Quantity	4 000	---	2350 201 10...L
	5 000	2350 230 10...L	---

For ordering rules: See page 14 for E24 / E96 values and the last 4 or 3 digits of the 12NC catalogue number



Chip Resistors Selection Charts

AC - Automotive grade chip resistors, 0201 to 2512

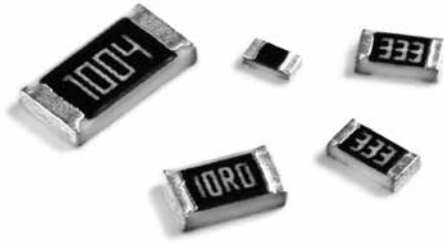

Features

- AEC-Q200 qualified
- Production part approval process (PPAP) support
- High reliability
- High quality level

Derating curve

Maximum dissipation (P) in percentage of rated power as a function of the operating ambient temperature (T_{amb}).

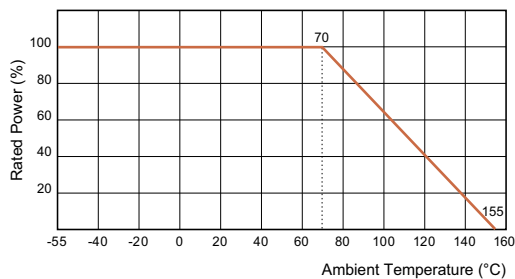

Construction

All size range except AC2010/ 2512 double power

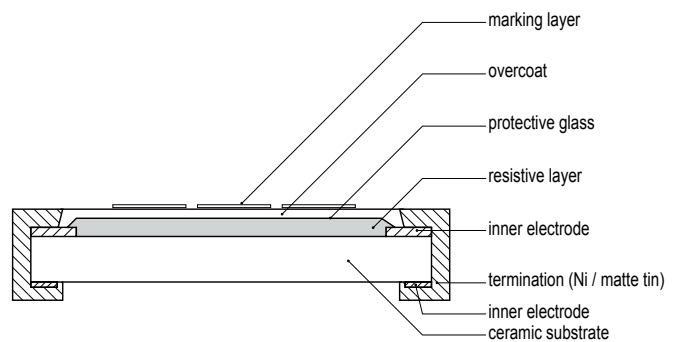

AC2010/ 2512 double power

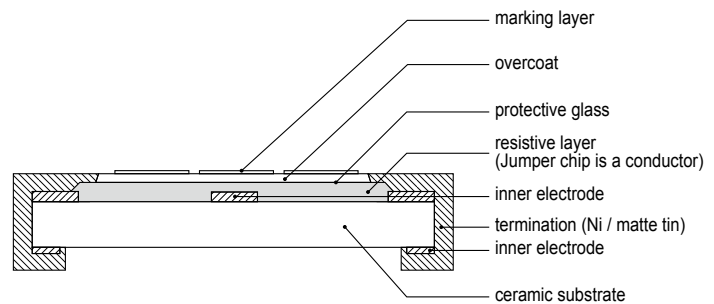

Dimensions

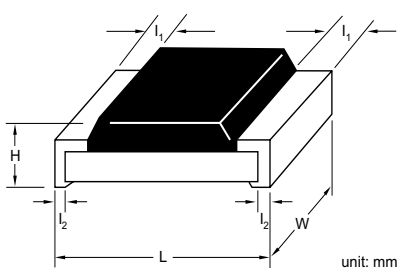

Type	L	W	H	l_1	l_2
AC0201	0.60 ± 0.03	0.30 ± 0.03	0.23 ± 0.03	0.12 ± 0.05	0.15 ± 0.05
AC0402	1.00 ± 0.05	0.50 ± 0.05	0.32 ± 0.05	0.20 ± 0.10	0.25 ± 0.10
AC0603	1.60 ± 0.10	0.80 ± 0.10	0.45 ± 0.10	0.25 ± 0.15	0.25 ± 0.15
AC0805	2.00 ± 0.10	1.25 ± 0.10	0.50 ± 0.10	0.35 ± 0.20	0.35 ± 0.20
AC1206	3.10 ± 0.10	1.60 ± 0.10	0.55 ± 0.10	0.45 ± 0.20	0.40 ± 0.20
AC1210	3.10 ± 0.10	2.60 ± 0.15	0.55 ± 0.10	0.45 ± 0.15	0.50 ± 0.20
AC1218	3.10 ± 0.10	4.60 ± 0.10	0.55 ± 0.10	0.45 ± 0.20	0.40 ± 0.20
AC2010	5.00 ± 0.10	2.50 ± 0.15	0.55 ± 0.10	0.55 ± 0.15	0.50 ± 0.20
AC2512	6.35 ± 0.10	3.10 ± 0.15	0.55 ± 0.10	0.60 ± 0.20	0.50 ± 0.20



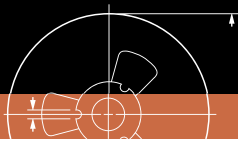

Chip Resistors Selection Charts

AC - Automotive grade chip resistors, 0201 to 2512

Electrical characteristics								
Type	Power P ₇₀	Operating Temp. range	MWV	RCOV	DWV	Resistance range & tolerance	T. C. R.	Jumper criteria (unit: A)
AC0201	1/20W	-55°C to 155°C	25V	50V	50V	E24 ±1%, ±5% 1Ω ≤ R ≤ 10MΩ E24/E96 ±0.5% 10Ω ≤ R ≤ 1MΩ Jumper < 50mΩ	1Ω ≤ R ≤ 10Ω -100/+350 ppm/°C 10Ω < R ≤ 10MΩ ±200 ppm/°C	Rated Current 0.5A Max. Current 1.0A
AC0402	1/16W		50V	100V	100V	E24 ±5% 1Ω ≤ R ≤ 22MΩ E24/E96 ±0.5%, ±1% 1Ω ≤ R ≤ 10MΩ Jumper < 50mΩ	1Ω ≤ R ≤ 10Ω ±200 ppm/°C 10Ω < R ≤ 10MΩ ±100 ppm/°C 10MΩ < R ≤ 22MΩ ±200 ppm/°C	Rated Current 1A Max. Current 2A
	1/8W		50V	100V	100V	E24 ±5% 1Ω ≤ R ≤ 10MΩ E24/E96 ±1%, 0.5% 1Ω ≤ R ≤ 10MΩ	1Ω ≤ R ≤ 10Ω ±200 ppm/°C 10Ω < R ≤ 10MΩ ±100 ppm/°C	--
AC0603	1/10W		75V	150V	150V	E24 ±5% 1Ω ≤ R ≤ 22MΩ E24/E96 ±0.5%, ±1% 1Ω ≤ R ≤ 10MΩ Jumper < 50mΩ	1Ω ≤ R ≤ 10Ω ±200 ppm/°C 10Ω < R ≤ 10MΩ ±100 ppm/°C 10MΩ < R ≤ 22MΩ ±200 ppm/°C	Rated Current 1A Max. Current 2A
	1/5W		75V	150V	150V	E24 ±5% 1Ω ≤ R ≤ 10MΩ E24/E96 ±1%, 0.5% 1Ω ≤ R ≤ 10MΩ	1Ω ≤ R ≤ 10Ω ±200 ppm/°C 10Ω < R ≤ 10MΩ ±100 ppm/°C	--
AC0805	1/8W		150V	300V	300V	E24 ±5% 1Ω ≤ R ≤ 22MΩ E24/E96 ±0.5%, ±1% 1Ω ≤ R ≤ 10MΩ Jumper < 50mΩ	1Ω ≤ R ≤ 10Ω ±200 ppm/°C 10Ω < R ≤ 10MΩ ±100 ppm/°C 10MΩ < R ≤ 22MΩ ±200 ppm/°C	Rated Current 2A Max. Current 5A
	1/4W		150V	300V	300V	E24 ±5% 1Ω ≤ R ≤ 10MΩ E24/E96 ±1%, 0.5% 1Ω ≤ R ≤ 10MΩ	1Ω ≤ R ≤ 10Ω ±200 ppm/°C 10Ω < R ≤ 10MΩ ±100 ppm/°C	--
AC1206	1/4W		200V	400V	500V	E24 ±5% 1Ω ≤ R ≤ 22MΩ E24/E96 ±0.5%, ±1% 1Ω ≤ R ≤ 10MΩ Jumper < 50mΩ	1Ω ≤ R ≤ 10Ω ±200 ppm/°C 10Ω < R ≤ 10MΩ ±100 ppm/°C 10MΩ < R ≤ 22MΩ ±200 ppm/°C	Rated Current 2A Max. Current 10A
	1/2W		200V	400V	500V	E24 ±5% 1Ω ≤ R ≤ 10MΩ E24/E96 ±1%, 0.5% 1Ω ≤ R ≤ 10MΩ	1Ω ≤ R ≤ 10Ω ±200 ppm/°C 10Ω < R ≤ 10MΩ ±100 ppm/°C	--
AC1210	1/2W		200V	500V	500V	E24 ±5% 1Ω ≤ R ≤ 22MΩ E24/E96 ±0.5%, ±1% 1Ω ≤ R ≤ 10MΩ Jumper < 50mΩ	1Ω ≤ R ≤ 10Ω ±200 ppm/°C 10Ω < R ≤ 10MΩ ±100 ppm/°C 10MΩ < R ≤ 22MΩ ±200 ppm/°C	Rated Current 2A Max. Current 10A
	1W		200V	500V	500V	E24 ±5% 1Ω ≤ R ≤ 10MΩ E24/E96 ±1%, 0.5% 1Ω ≤ R ≤ 10MΩ	1Ω ≤ R ≤ 10Ω ±200 ppm/°C 10Ω < R ≤ 10MΩ ±100 ppm/°C	--
AC1218	1W		200V	500V	500V	E24 ±5% 1Ω ≤ R ≤ 1MΩ E24/E96 ±0.5%, ±1% 1Ω ≤ R ≤ 1MΩ Jumper < 50mΩ	1Ω ≤ R ≤ 10Ω ±200 ppm/°C 10Ω < R ≤ 1MΩ ±100 ppm/°C	Rated Current 6A Max. Current 10A
	1.5W		200V	500V	500V	E24 ±5% 1Ω ≤ R ≤ 1MΩ E24/E96 ±1%, 0.5% 1Ω ≤ R ≤ 1MΩ	1Ω ≤ R ≤ 10Ω ±200 ppm/°C 10Ω < R ≤ 1MΩ ±100 ppm/°C	--
AC2010	3/4W		200V	500V	500V	E24 ±5% 1Ω ≤ R ≤ 22MΩ E24/E96 ±0.5%, ±1% 1Ω ≤ R ≤ 10MΩ Jumper < 50mΩ	1Ω ≤ R ≤ 10Ω ±200 ppm/°C 10Ω < R ≤ 10MΩ ±100 ppm/°C 10MΩ < R ≤ 22MΩ ±200 ppm/°C	Rated Current 2A Max. Current 10A
	1.25W		200V	500V	500V	E24 ±5% 1Ω ≤ R ≤ 10MΩ E24/E96 ±1%, 0.5% 1Ω ≤ R ≤ 10MΩ	1Ω ≤ R ≤ 10Ω ±200 ppm/°C 10Ω < R ≤ 10MΩ ±100 ppm/°C	--
AC2512	1W		200V	500V	500V	E24 ±5% 1Ω ≤ R ≤ 22MΩ E24/E96 ±0.5%, ±1% 1Ω ≤ R ≤ 10MΩ Jumper < 50mΩ	1Ω ≤ R ≤ 10Ω ±200 ppm/°C 10Ω < R ≤ 10MΩ ±100 ppm/°C 10MΩ < R ≤ 22MΩ ±200 ppm/°C	Rated Current 2A Max. Current 10A
	2W		200V	500V	500V	E24 ±5% 1Ω ≤ R ≤ 10MΩ E24/E96 ±1%, 0.5% 1Ω ≤ R ≤ 10MΩ	1Ω ≤ R ≤ 10Ω ±200 ppm/°C 10Ω < R ≤ 10MΩ ±100 ppm/°C	--



Chip Resistors Selection Charts

AC - Automotive grade chip resistors, 0201 to 2512

Environmental characteristics				
Performance test		Test method	Procedure	Requirements
Life		AEC-Q200-REV C-Test 8 MIL-STD-202 Method 108	1000 hours at 125°C applied RCWV 1.5 hours on, 0.5 hours off	± (1%+50mΩ) for D/F tol ± (3%+50mΩ) for J tol < 100 mΩ for Jumper
High temperature exposure		AEC-Q200 Test 3 MIL-STD-202 Method 108	1000 hours at TA = 155°C, unpowered	± (1%+50mΩ) for D/F tol ± (2%+50mΩ) for J tol < 50 mΩ for Jumper
Moisture resistance		AEC-Q200 Test 6 MIL-STD-202 Method 106	Each temperature / humidity cycle is defined as 8 hours (method 106F), 3 cycles / 24 hours for 10d with 25°C / 65°C 95% R.H.	± (0.5%+50mΩ) for D/F tol ± (2%+50mΩ) for J tol < 100 mΩ for Jumper
Biased humidity		AEC-Q200 Test 7 MIL-STD-202 Method 103	1000 hours; + 85°C 85% R.H.; 10% of operating power Measured at 24 ±2 hours after test	± (1%+50mΩ) for D/F tol ± (3%+50mΩ) for J tol < 100 mΩ for Jumper
Thermal shock		AEC-Q200 Test 16 MIL-STD-202 Method 107	-55 / +125°C Number of cycles is 300. Devices mounted Maximum transfer time is 20 seconds. Dwell time is 15 minutes. Air – Air	± (0.5%+50mΩ) for D/F tol ± (1%+50mΩ) for J tol < 50 mΩ for Jumper
Solderability	Wetting	AEC-Q200 Test 18 J-STD-002B test B	Electrical test not required. Magnification 50X Lead-free solder bath at 245 ±3°C Dipping time: 3 ±0.5 seconds	Well tinned (≥ 95% covered) No visible damage
	Resistance to soldering heat	AEC-Q200 Test 15 MIL-STD-202 Method 215	Lead-free solder, 260°C, 10 seconds immersion time	± (0.5%+50mΩ) for D/F tol ± (1%+50mΩ) for J tol < 50 mΩ for Jumper No visible damage
Short time overload		IEC60115-1 4.13	2.5 times RCWV or maximum overload voltage which- ever is less for 5 seconds at room temperature	± (1%+50mΩ) for D/F tol ± (2%+50mΩ) for J tol < 50 mΩ for Jumper
ESD		AEC-Q200 Test 17 AEC-Q200-002	Human Body Mode, 1 pos. + 1 neg. discharges 0402/0603: 1KV 0805 and above: 2KV	± (3.0%+0.05Ω)
FOS		ASTM-B-809-95	Sulfur (saturated vapor) 500 hours, 60 ±2°C unpowered	± (1.0%+0.05Ω)

Global part number - Preferred type

Ordering example: AC0603JR-07100KL

<p>Series name (code 1-2) _____</p> <p>AC = Automotive grade</p> <p>Size code (code 3-6) _____</p> <p>(inch / metric)</p> <p>0201 = 0.6 x 0.3</p> <p>0402 = 1.0 x 0.5</p> <p>0603 = 1.6 x 0.8</p> <p>0612 = 1.6 x 3.2</p> <p>0805 = 2.0 x 1.25</p> <p>1020 = 2.5 x 5.0</p> <p>1206 = 3.2 x 1.6</p> <p>1210 = 3.2 x 2.6</p> <p>1218 = 3.2 x 4.5</p> <p>1225 = 3.2 x 6.4</p> <p>2010 = 5.0 x 2.5</p> <p>2512 = 6.35 x 3.2</p> <p>Tolerance (code 7) _____</p> <p>D = ±0.5%</p> <p>F = ±1%</p> <p>J = ±5% (for jumper ordering)</p>	<p>AC 0603 J R — 07 100K L</p>	<p>Default code^(1/2) (code 17)</p> <p>Resistance (code 12-16)</p> <p>0R = Jumper</p> <p>10R = 10Ω</p> <p>100R = 100Ω</p> <p>100K = 100KΩ</p> <p>Taping reel (code 10-11)</p> <p>07 = 7 inch Dia. reel</p> <p>10 = 10 inch Dia. reel</p> <p>13 = 13 inch Dia. reel</p> <p>7W = 7 inch Dia. reel</p> <p>2 x standard power type</p> <p>3W = 13 inch Dia. reel</p> <p>2 x standard power type</p> <p>T. C. R. (code 9)</p> <p>“—” = Based on spec.</p> <p>(— for thick film only)</p> <p>Packing style (code 8)</p> <p>R = Paper tape reel</p> <p>K = Embossed plastic tape reel</p>
--	---------------------------------------	---

Note: 1. All of our RSMD products are RoHS compliant. "LFP" of the internal 2D reel label mentions "Lead Free Process"
 2. Letter L is system default code for ordering only
 3. AC series products are available by "Global part number" only



Chip Resistors Selection Charts

AC - Automotive grade chip resistors, wide termination , 0612 to 1225



Features

- AEC-Q200 qualified
- Production part approval process (PPAP) support
- High reliability
- High quality level

Derating curve	Construction																
<p>Maximum dissipation (P) in percentage of rated power as a function of the operating ambient temperature (T_{amb}).</p> <table border="1"> <caption>Derating Curve Data</caption> <thead> <tr> <th>Ambient Temperature (°C)</th> <th>Rated Power (%)</th> </tr> </thead> <tbody> <tr><td>-55</td><td>100</td></tr> <tr><td>0</td><td>100</td></tr> <tr><td>60</td><td>100</td></tr> <tr><td>70</td><td>100</td></tr> <tr><td>100</td><td>66.7</td></tr> <tr><td>140</td><td>33.3</td></tr> <tr><td>155</td><td>15</td></tr> </tbody> </table>	Ambient Temperature (°C)	Rated Power (%)	-55	100	0	100	60	100	70	100	100	66.7	140	33.3	155	15	
Ambient Temperature (°C)	Rated Power (%)																
-55	100																
0	100																
60	100																
70	100																
100	66.7																
140	33.3																
155	15																

Dimensions																									
<p style="text-align: right;">unit: mm</p>	<table border="1"> <thead> <tr> <th>Type</th> <th>L</th> <th>W</th> <th>H</th> <th>l_1</th> <th>l_2</th> </tr> </thead> <tbody> <tr> <td>AC0612</td> <td>1.60 ± 0.20</td> <td>3.20 ± 0.20</td> <td>0.55 ± 0.10</td> <td>0.18 ± 0.15</td> <td>0.40 ± 0.15</td> </tr> <tr> <td>AC1020</td> <td>2.50 ± 0.20</td> <td>5.00 ± 0.20</td> <td>0.55 ± 0.10</td> <td>0.25 ± 0.20</td> <td>0.90 ± 0.20</td> </tr> <tr> <td>AC1225</td> <td>3.20 ± 0.20</td> <td>6.40 ± 0.20</td> <td>0.55 ± 0.10</td> <td>0.45 ± 0.20</td> <td>0.75 ± 0.20</td> </tr> </tbody> </table>	Type	L	W	H	l_1	l_2	AC0612	1.60 ± 0.20	3.20 ± 0.20	0.55 ± 0.10	0.18 ± 0.15	0.40 ± 0.15	AC1020	2.50 ± 0.20	5.00 ± 0.20	0.55 ± 0.10	0.25 ± 0.20	0.90 ± 0.20	AC1225	3.20 ± 0.20	6.40 ± 0.20	0.55 ± 0.10	0.45 ± 0.20	0.75 ± 0.20
Type	L	W	H	l_1	l_2																				
AC0612	1.60 ± 0.20	3.20 ± 0.20	0.55 ± 0.10	0.18 ± 0.15	0.40 ± 0.15																				
AC1020	2.50 ± 0.20	5.00 ± 0.20	0.55 ± 0.10	0.25 ± 0.20	0.90 ± 0.20																				
AC1225	3.20 ± 0.20	6.40 ± 0.20	0.55 ± 0.10	0.45 ± 0.20	0.75 ± 0.20																				

Electrical characteristics								
Type	Power P_{70}	Operating Temp. range	MWV	RCOV	DWV	Resistance range & tolerance	T. C. R.	Jumper criteria (unit: A)
AC0612	3/4W	-55°C to 155°C	200V	400V	500V	E24 $\pm 5\%$ $1\Omega \leq R \leq 1M\Omega$ E24/E96 $\pm 0.5\%, \pm 1\%$ $1\Omega \leq R \leq 1M\Omega$ Jumper $< 50m\Omega$	$1\Omega \leq R \leq 10\Omega \pm 200 \text{ ppm}/^\circ\text{C}$ $10\Omega < R \leq 1M\Omega \pm 100 \text{ ppm}/^\circ\text{C}$	Rated Current 2A Max. Current 10A
AC1020	1W		200V	400V	500V			
AC1225	2W		200V	400V	500V			



Chip Resistors Selection Charts

AC - Automotive grade chip resistors, wide termination , 0612 to 1225

Environmental characteristics				
Performance test		Test method	Procedure	Requirements
Life		AEC-Q200-REV C-Test 8 MIL-STD-202 Method 108	1000 hours at 125°C applied RCWV 1.5 hours on, 0.5 hours off	± (1%+50mΩ) for D/F tol ± (3%+50mΩ) for J tol < 100 mΩ for Jumper
High temperature exposure		AEC-Q200 Test 3 MIL-STD-202 Method 108	1000 hours at maximum operating temperature depending on specification	± (1%+50mΩ) for D/F tol ± (2%+50mΩ) for J tol < 50 mΩ for Jumper
Moisture resistance		AEC-Q200 Test 6 MIL-STD-202 Method 106	Each temperature / humidity cycle is defined as 8 hours (method 106F), 3 cycles / 24 hours for 10d with 25°C / 65°C 95% R.H.	± (0.5%+50mΩ) for D/F tol ± (2%+50mΩ) for J tol < 100 mΩ for Jumper
Biased humidity		AEC-Q200 Test 7 MIL-STD-202 Method 103	1000 hours; + 85°C 85% R.H.; 10% of operating power Measured at 24 ±2 hours after test	± (1%+50mΩ) for D/F tol ± (3%+50mΩ) for J tol < 100 mΩ for Jumper
Thermal shock		AEC-Q200 Test 16 MIL-STD-202 Method 107	-55 / +125°C Number of cycles is 300. Devices mounted Maximum transfer time is 20 seconds. Dwell time is 15 minutes. Air – Air	± (0.5%+50mΩ) for D/F tol ± (1%+50mΩ) for J tol < 50 mΩ for Jumper
Solderability	Wetting	AEC-Q200 Test 18 J-STD-002B test B	Electrical test not required. Magnification 50X Lead-free solder bath at 245 ±3°C Dipping time: 3 ±0.5 seconds	Well tinned (≥ 95% covered) No visible damage
	Resistance to soldering heat	AEC-Q200 Test 15 MIL-STD-202 Method 215	Lead-free solder, 260°C, 10 seconds immersion time	± (0.5%+50mΩ) for D/F tol ± (1%+50mΩ) for J tol < 50 mΩ for Jumper No visible damage
Short time overload		IEC60115-1 4.13	2.5 times RCWV or maximum overload voltage whichever is less for 5 seconds at room temperature	± (1%+50mΩ) for D/F tol ± (2%+50mΩ) for J tol < 50 mΩ for Jumper

Global part number - Preferred type

Ordering example: AC0612FR-07100KL

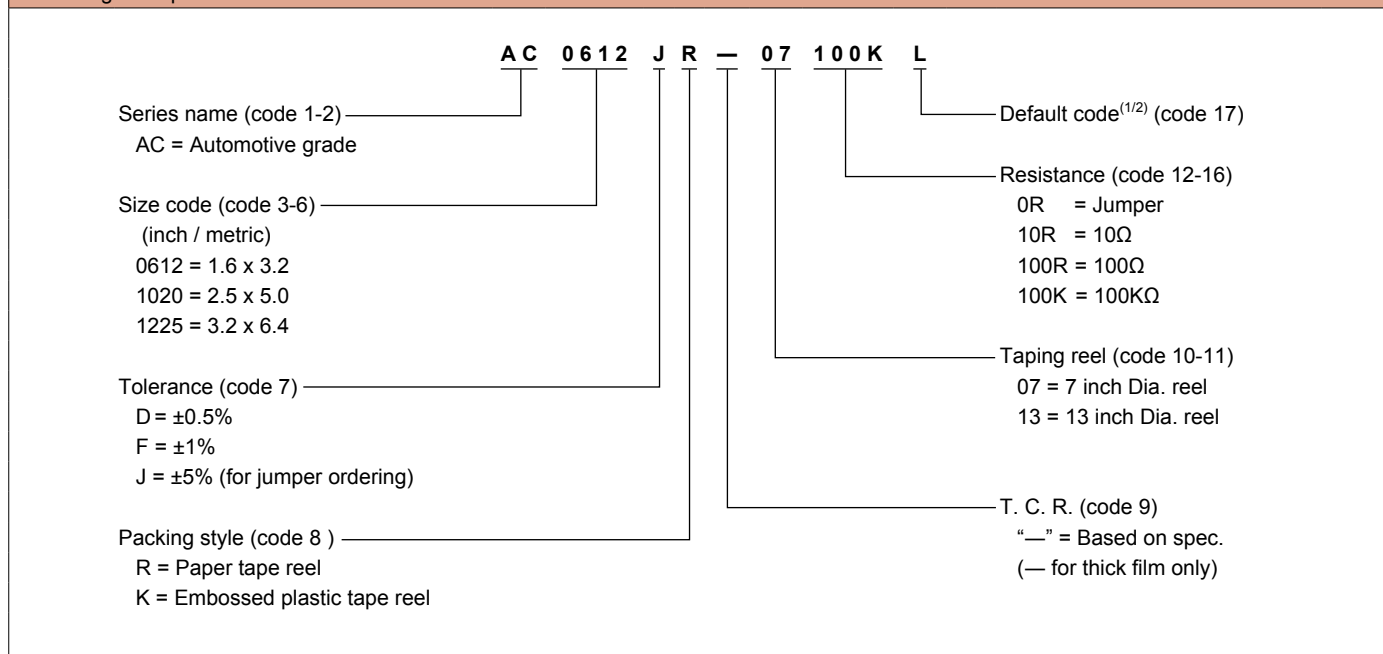

Note: 1. All of our RSMD products are RoHS compliant. "LFP" of the internal 2D reel label mentions "Lead Free Process"
2. Letter L is system default code for ordering only
3. AC wide series products are available by "Global part number" only



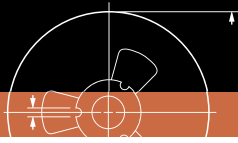

Chip Resistors Selection Charts

AC - Automotive grade chip resistors, TCR 50ppm, 0402 to 1206

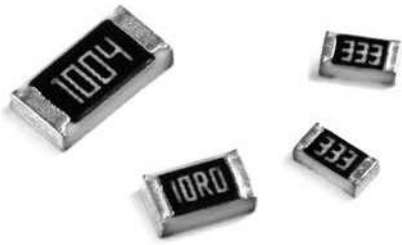

Features

- AEC-Q200 qualified
- Narrow tolerance
- Low T. C. R.
- Highly reliable construction
- Compatible with all soldering processes
- RoHS compliant
- Moisture sensitivity level: MSL I

Derating curve	Construction
<p>Maximum dissipation (P) in percentage of rated power as a function of the operating ambient temperature (T_{amb}).</p> <p>Rated Power (%)</p> <p>Ambient Temperature (°C)</p>	

Dimensions																															
<p>unit: mm</p>	<table border="1"> <thead> <tr> <th>Type</th> <th>L</th> <th>W</th> <th>H</th> <th>l_1</th> <th>l_2</th> </tr> </thead> <tbody> <tr> <td>AC0402</td> <td>1.00 ± 0.05</td> <td>0.50 ± 0.05</td> <td>0.32 ± 0.05</td> <td>0.20 ± 0.10</td> <td>0.25 ± 0.10</td> </tr> <tr> <td>AC0603</td> <td>1.60 ± 0.10</td> <td>0.80 ± 0.10</td> <td>0.45 ± 0.10</td> <td>0.25 ± 0.15</td> <td>0.25 ± 0.15</td> </tr> <tr> <td>AC0805</td> <td>2.00 ± 0.10</td> <td>1.25 ± 0.10</td> <td>0.50 ± 0.10</td> <td>0.35 ± 0.20</td> <td>0.35 ± 0.20</td> </tr> <tr> <td>AC1206</td> <td>3.10 ± 0.10</td> <td>1.60 ± 0.10</td> <td>0.55 ± 0.10</td> <td>0.45 ± 0.20</td> <td>0.40 ± 0.20</td> </tr> </tbody> </table>	Type	L	W	H	l_1	l_2	AC0402	1.00 ± 0.05	0.50 ± 0.05	0.32 ± 0.05	0.20 ± 0.10	0.25 ± 0.10	AC0603	1.60 ± 0.10	0.80 ± 0.10	0.45 ± 0.10	0.25 ± 0.15	0.25 ± 0.15	AC0805	2.00 ± 0.10	1.25 ± 0.10	0.50 ± 0.10	0.35 ± 0.20	0.35 ± 0.20	AC1206	3.10 ± 0.10	1.60 ± 0.10	0.55 ± 0.10	0.45 ± 0.20	0.40 ± 0.20
Type	L	W	H	l_1	l_2																										
AC0402	1.00 ± 0.05	0.50 ± 0.05	0.32 ± 0.05	0.20 ± 0.10	0.25 ± 0.10																										
AC0603	1.60 ± 0.10	0.80 ± 0.10	0.45 ± 0.10	0.25 ± 0.15	0.25 ± 0.15																										
AC0805	2.00 ± 0.10	1.25 ± 0.10	0.50 ± 0.10	0.35 ± 0.20	0.35 ± 0.20																										
AC1206	3.10 ± 0.10	1.60 ± 0.10	0.55 ± 0.10	0.45 ± 0.20	0.40 ± 0.20																										

Electrical characteristics							
Type	Power P_{70}	Operating Temp. range	MWV	RCOV	DWV	Resistance range & tolerance	T. C. R.
AC0402	1/16W	-55°C to +155°C	50V	100V	100V	E24/E96 ±0.1%, ±0.5%, ±1% 10Ω ≤ R ≤ 1MΩ	±50 ppm/°C
AC0603	1/10W		75V	150V	150V		
AC0805	1/8W		150V	300V	300V		
AC1206	1/4W		200V	400V	500V		



Chip Resistors Selection Charts

AC - Automotive grade chip resistors, TCR 50ppm, 0402 to 1206

Environmental characteristics				
Performance test		Test method	Procedure	Requirements
Life		MIL-STD-202 -method 108A	1000 hours at 70 ±2°C applied RCWV 1.5 hours on, 0.5 hours off, still air required	± (1% +50mΩ)
High temperature exposure		MIL-STD-202 -method 108A	1000 hours at maximum operating temperature depending on specification, unpowered	± (1% +50mΩ)
Moisture resistance		MIL-STD-202 -method 106G	Each temperature / humidity cycle is defined as 8 hours (method 106G), 3 cycles / 24 hours for 10d with 25°C / 65°C 95% R.H	± (0.5% +50mΩ)
Thermal shock		MIL-STD-202 -method 107G	-55 / +125°C Note: Number of cycles required is 300. Devices mounted Maximum transfer time is 20 seconds. Dwell time is 15 minutes. Air – Air	± (0.5% +50mΩ)
Solderability	Wetting	IPC/JEDECJ-STD-002B test B	Electrical test not required. Magnification 50X Lead-free solder bath at 245 ±3°C Dipping time: 3 ±0.5 seconds	Well tinned (≥ 95% covered) No visible damage
	Resistance to soldering heat	MIL-STD-202 -method 210F	Lead-free solder, 260°C, 10 seconds immersion time	± (0.5%+ 50mΩ) No visible damage
Short time overload		IEC 60115 -1 4.13	2.5 times RCWV or maximum overload voltage whichever is less for 5 seconds at room temperature	± (1%+ 50mΩ) No visible damage
Biased Humidity		AEC-Q200 -Test 7 MIL-STD-202 -method 103	1,000 hours; 85°C / 85% RH 10% of operating power Measurement at 24± 4 hours after test conclusion.	± (1.0%+0.05Ω)
ESD		AEC-Q200 -Test 17 AEC-Q200-002	Human Body Mode, 1 pos. + 1 neg. discharges 0402/0603: 1KV 0805 and above: 2KV	± (3.0%+0.05 Ω)
FOS		ASTM-B-809-95	Sulfur (saturated vapor) 500 hours, 60± 2°C unpowered	± (1.0%+0.05Ω)

Global part number - Preferred type for ordering Yageo / Phycomp branded products

Ordering example: AC0603DRE07100KL

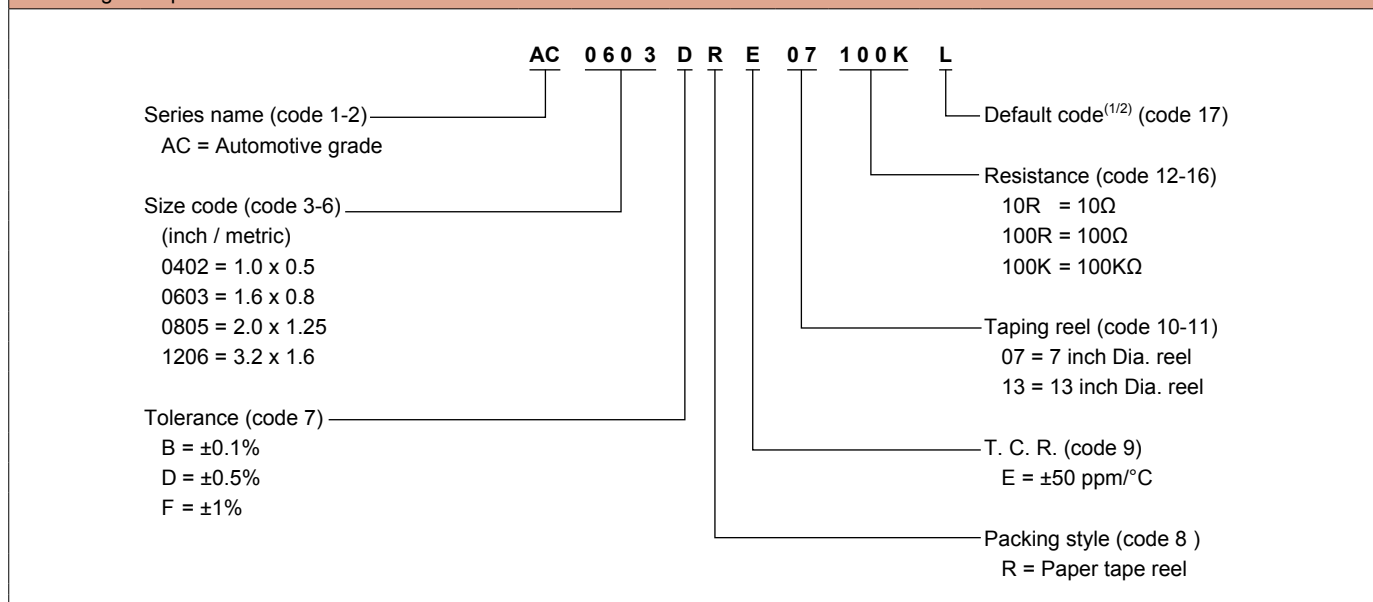

Note: 1. All of our RSMD products are RoHS compliant. "LFP" of the internal 2D reel label mentions "Lead Free Process"
2. Letter L is system default code for ordering only
3. AC series products are available by "Global part number" only

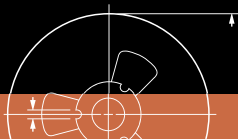

Chip Resistors Selection Charts

AF - Sulfur resistant chip resistors, 0201 to 2512



Features

- AEC-Q200 qualified
- Superior resistance against sulfur containing atmosphere
- Highly reliable electrode construction
- Compatible with all soldering processes
- Highly stable in auto-placement surface mounting applications
- Halogen free product and production

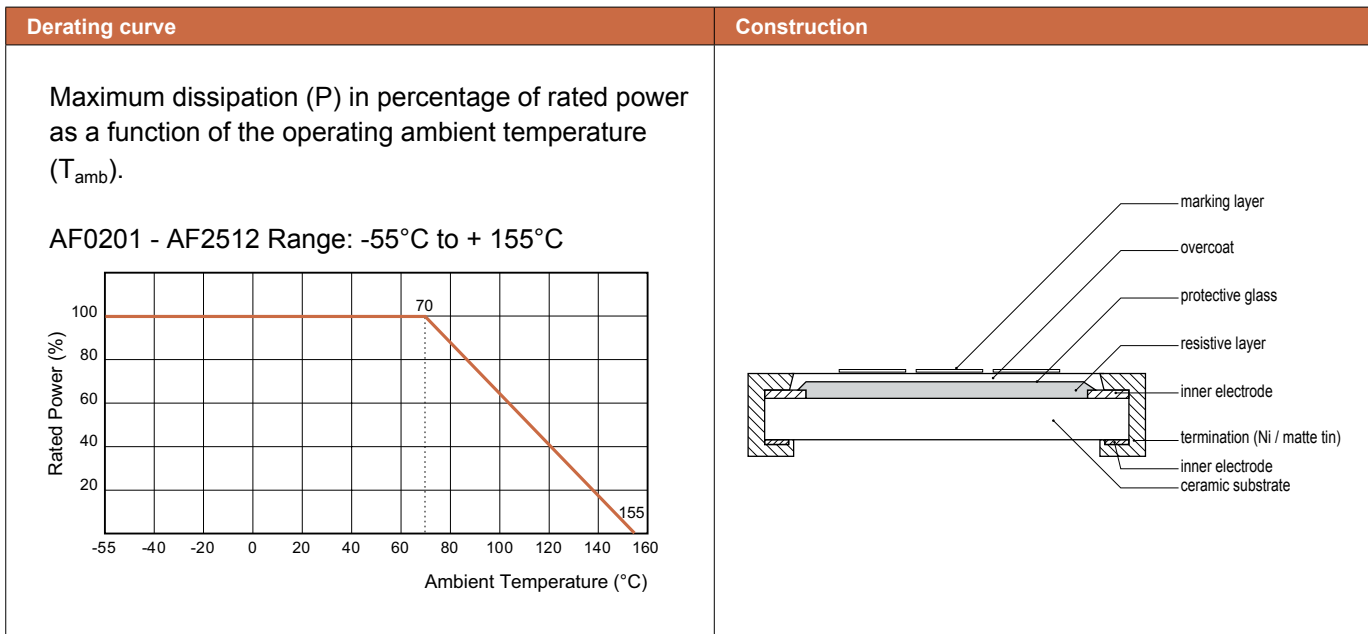

Dimensions																																																													
<p style="text-align: right;">unit: mm</p>	<table border="1"> <thead> <tr> <th>Type</th> <th>L</th> <th>W</th> <th>H</th> <th>l_1</th> <th>l_2</th> </tr> </thead> <tbody> <tr><td>AF0201</td><td>0.60 ± 0.03</td><td>0.30 ± 0.03</td><td>0.23 ± 0.03</td><td>0.12 ± 0.05</td><td>0.15 ± 0.05</td></tr> <tr><td>AF0402</td><td>1.00 ± 0.05</td><td>0.50 ± 0.05</td><td>0.35 ± 0.05</td><td>0.20 ± 0.10</td><td>0.25 ± 0.10</td></tr> <tr><td>AF0603</td><td>1.60 ± 0.10</td><td>0.80 ± 0.10</td><td>0.45 ± 0.10</td><td>0.25 ± 0.15</td><td>0.25 ± 0.15</td></tr> <tr><td>AF0805</td><td>2.00 ± 0.10</td><td>1.25 ± 0.10</td><td>0.50 ± 0.10</td><td>0.35 ± 0.20</td><td>0.35 ± 0.20</td></tr> <tr><td>AF1206</td><td>3.10 ± 0.10</td><td>1.60 ± 0.10</td><td>0.55 ± 0.10</td><td>0.45 ± 0.20</td><td>0.50 ± 0.20</td></tr> <tr><td>AF1210</td><td>3.10 ± 0.10</td><td>2.60 ± 0.15</td><td>0.57 ± 0.10</td><td>0.45 ± 0.20</td><td>0.50 ± 0.20</td></tr> <tr><td>AF1218</td><td>3.10 ± 0.10</td><td>4.60 ± 0.10</td><td>0.57 ± 0.10</td><td>0.45 ± 0.20</td><td>0.50 ± 0.20</td></tr> <tr><td>AF2010</td><td>5.00 ± 0.10</td><td>2.50 ± 0.15</td><td>0.57 ± 0.10</td><td>0.55 ± 0.20</td><td>0.55 ± 0.20</td></tr> <tr><td>AF2512</td><td>6.35 ± 0.10</td><td>3.10 ± 0.15</td><td>0.57 ± 0.10</td><td>0.60 ± 0.20</td><td>0.60 ± 0.20</td></tr> </tbody> </table>	Type	L	W	H	l_1	l_2	AF0201	0.60 ± 0.03	0.30 ± 0.03	0.23 ± 0.03	0.12 ± 0.05	0.15 ± 0.05	AF0402	1.00 ± 0.05	0.50 ± 0.05	0.35 ± 0.05	0.20 ± 0.10	0.25 ± 0.10	AF0603	1.60 ± 0.10	0.80 ± 0.10	0.45 ± 0.10	0.25 ± 0.15	0.25 ± 0.15	AF0805	2.00 ± 0.10	1.25 ± 0.10	0.50 ± 0.10	0.35 ± 0.20	0.35 ± 0.20	AF1206	3.10 ± 0.10	1.60 ± 0.10	0.55 ± 0.10	0.45 ± 0.20	0.50 ± 0.20	AF1210	3.10 ± 0.10	2.60 ± 0.15	0.57 ± 0.10	0.45 ± 0.20	0.50 ± 0.20	AF1218	3.10 ± 0.10	4.60 ± 0.10	0.57 ± 0.10	0.45 ± 0.20	0.50 ± 0.20	AF2010	5.00 ± 0.10	2.50 ± 0.15	0.57 ± 0.10	0.55 ± 0.20	0.55 ± 0.20	AF2512	6.35 ± 0.10	3.10 ± 0.15	0.57 ± 0.10	0.60 ± 0.20	0.60 ± 0.20
Type	L	W	H	l_1	l_2																																																								
AF0201	0.60 ± 0.03	0.30 ± 0.03	0.23 ± 0.03	0.12 ± 0.05	0.15 ± 0.05																																																								
AF0402	1.00 ± 0.05	0.50 ± 0.05	0.35 ± 0.05	0.20 ± 0.10	0.25 ± 0.10																																																								
AF0603	1.60 ± 0.10	0.80 ± 0.10	0.45 ± 0.10	0.25 ± 0.15	0.25 ± 0.15																																																								
AF0805	2.00 ± 0.10	1.25 ± 0.10	0.50 ± 0.10	0.35 ± 0.20	0.35 ± 0.20																																																								
AF1206	3.10 ± 0.10	1.60 ± 0.10	0.55 ± 0.10	0.45 ± 0.20	0.50 ± 0.20																																																								
AF1210	3.10 ± 0.10	2.60 ± 0.15	0.57 ± 0.10	0.45 ± 0.20	0.50 ± 0.20																																																								
AF1218	3.10 ± 0.10	4.60 ± 0.10	0.57 ± 0.10	0.45 ± 0.20	0.50 ± 0.20																																																								
AF2010	5.00 ± 0.10	2.50 ± 0.15	0.57 ± 0.10	0.55 ± 0.20	0.55 ± 0.20																																																								
AF2512	6.35 ± 0.10	3.10 ± 0.15	0.57 ± 0.10	0.60 ± 0.20	0.60 ± 0.20																																																								



Chip Resistors Selection Charts

AF - Sulfur resistant chip resistors, 0201 to 2512

Electrical characteristics								
Type	Power P ₇₀	Operating Temp. range	MWV	RCOV	DWV	Resistance range & tolerance	T. C. R.	Jumper criteria (unit: A)
AF0201	1/20W	-55°C to +155°C	25V	50V	50V	E24 ±5% 1Ω ≤ R ≤ 10MΩ E24/E96 ±0.5%, ±1% 1Ω ≤ R ≤ 10MΩ Jumper < 50mΩ	1Ω ≤ R ≤ 10Ω -100/ 350 ppm/°C 10Ω < R ≤ 10MΩ ±200 ppm/°C	Rated current 0.5 Max. current 1.0
AF0402	1/16W		50V	100V	100V	5% (E24) 1Ω ≤ R ≤ 22MΩ 0.5%, 1% (E24/E96) 1Ω ≤ R ≤ 10MΩ Jumper < 50mΩ	1Ω ≤ R ≤ 10Ω ±200ppm/°C 10Ω < R ≤ 10MΩ ±100ppm/°C 10MΩ < R ≤ 22MΩ ±200ppm/°C	Rated current 1.0 Max. current 2.0
	1/8W		50V	100V	100V	5% (E24) 1Ω ≤ R ≤ 10MΩ 0.5%, 1%, (E24/E96) 1Ω ≤ R ≤ 10MΩ	1Ω ≤ R ≤ 10Ω ±200 ppm/°C 10Ω < R ≤ 10MΩ ±100 ppm/°C	-
AF0603	1/10W		75V	150V	150V	5% (E24) 1Ω ≤ R ≤ 22MΩ 0.5%, 1% (E24/E96) 1Ω ≤ R ≤ 10MΩ Jumper < 50mΩ	1Ω ≤ R ≤ 10Ω ±200ppm/°C 10Ω < R ≤ 10MΩ ±100ppm/°C 10MΩ < R ≤ 22MΩ ±200ppm/°C	Rated current 1.0 Max. current 2.0
	1/5 W		75V	150V	150V	5% (E24) 1Ω ≤ R ≤ 10MΩ 0.5%, 1%, (E24/E96) 1Ω ≤ R ≤ 10MΩ	1Ω ≤ R ≤ 10Ω ±200 ppm/°C 10Ω < R ≤ 10MΩ ±100 ppm/°C	-
AF0805	1/8W		150V	300V	300V	5% (E24) 1Ω ≤ R ≤ 22MΩ 0.5%, 1% (E24/E96) 1Ω ≤ R ≤ 10MΩ Jumper < 50mΩ	1Ω ≤ R ≤ 10Ω ±200ppm/°C 10Ω < R ≤ 10MΩ ±100ppm/°C 10MΩ < R ≤ 22MΩ ±200ppm/°C	Rated current 2.0 Max. current 5.0
	1/4W		150V	300V	300V	5% (E24) 1Ω ≤ R ≤ 10MΩ 0.5%, 1%, (E24/E96) 1Ω ≤ R ≤ 10MΩ	1Ω ≤ R ≤ 10Ω ±200 ppm/°C 10Ω < R ≤ 10MΩ ±100 ppm/°C	-
AF1206	1/4W		200V	400V	500V	5% (E24) 1Ω ≤ R ≤ 22MΩ 0.5%, 1% (E24/E96) 1Ω ≤ R ≤ 10MΩ Jumper < 50mΩ	1Ω ≤ R ≤ 10Ω ±200ppm/°C 10Ω < R ≤ 10MΩ ±100ppm/°C 10MΩ < R ≤ 22MΩ ±200ppm/°C	Rated current 2.0 Max. current 10.0
	1/2 W		200V	400V	500V	5% (E24) 1Ω ≤ R ≤ 10MΩ 0.5%, 1%, (E24/E96) 1Ω ≤ R ≤ 10MΩ	1Ω ≤ R ≤ 10Ω ±200 ppm/°C 10Ω < R ≤ 10MΩ ±100 ppm/°C	-
AF1210	1/2W		200V	500V	500V	E24 ±5% 1Ω ≤ R ≤ 10MΩ E24/E96 ±0.5%, ±1% 1Ω ≤ R ≤ 10MΩ Jumper < 50mΩ	1Ω ≤ R ≤ 10Ω ±200 ppm/°C 10Ω < R ≤ 10MΩ ±100 ppm/°C	Rated current 2.0 Max. current 10.0
AF1218	1W		200V	500V	500V	E24 ±5% 1Ω ≤ R ≤ 1MΩ E24/E96 ±0.5%, ±1% 1Ω ≤ R ≤ 1MΩ Jumper < 50mΩ		Rated current 2.0 Max. current 10.0
AF2010	3/4W		200V	500V	500V	E24 ±5% 1Ω ≤ R ≤ 10MΩ E24/E96 ±0.5%, ±1% 1Ω ≤ R ≤ 10MΩ Jumper < 50mΩ		Rated current 2.0 Max. current 10.0
AF2512	1W	200V	500V	500V	E24 ±5% 1Ω ≤ R ≤ 10MΩ E24/E96 ±0.5%, ±1% 1Ω ≤ R ≤ 10MΩ Jumper < 50mΩ	Rated current 2.0 Max. current 10.0		

Environmental characteristics			
Performance test	Test method	Procedure	Requirements
Life	MIL-STD-202 Method 108	1000 hours at 70 ±2°C applied RCWV 1.5 hours on, 0.5 hours off, still air required	± (1% +50mΩ) < 100mΩ for jumper
High temperature exposure	MIL-STD-202 Method 108	1000 hours at maximum operating temperature depending on specification, unpowered	± (1% +50mΩ) < 100mΩ for jumper
Moisture resistance	MIL-STD-202 Method 106	Each temperature / humidity cycle is defined as 8 hours (method 106G), 3 cycles / 24 hours for 10d with 25°C / 65°C 95% R.H	± (0.5% +50mΩ) for 1% tol. ± (1% +50mΩ) for 5% tol. < 100mΩ for jumper
Thermal shock	MIL-STD-202 Method 107	-55 / +125°C Note: Number of cycles required is 300. Devices mounted Maximum transfer time is 20 seconds. Dwell time is 15 minutes. Air – Air	± (0.5% +50mΩ) for 1% tol. ± (1% +50mΩ) for 5% tol. < 100mΩ for jumper
Solderability	Wetting	J-STD-002B test B Electrical test not required. Magnification 50X Lead-free solder bath at 245 ±3°C Dipping time: 3 ±0.5 seconds	Well tinned (≥ 95% covered) No visible damage
	Resistance to soldering heat	MIL-STD-202 Method 215 Lead-free solder, 260°C, 10 seconds immersion time	± (1% +50mΩ) No visible damage
Short time overload	IEC60115-1 4.13	2.5 times RCWV or maximum overload voltage whichever is less for 5 seconds at room temperature	± (1% +50mΩ) No visible damage
FOS	ASTM-B-809-95* * Modified	Sulfur 750 hours, 105°C, Rating with no power	± (4% +50mΩ)



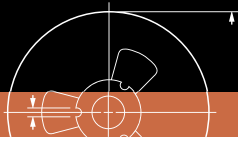

Chip Resistors Selection Charts

AF - Sulfur resistant chip resistors, 0201 to 2512

Global part number - Preferred type

Ordering example: AF0603JR-07100KL

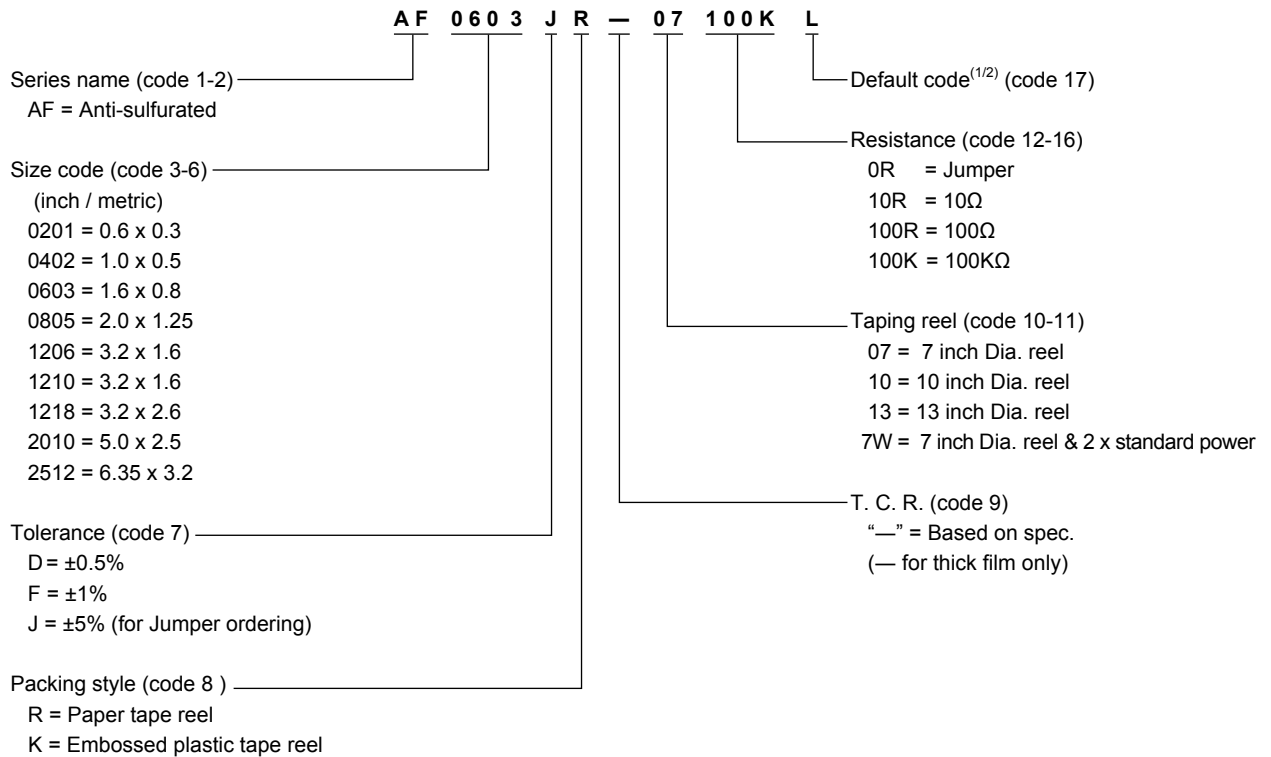

- Note:** 1. All our RSMD products meet RoHS Compliant. "LFP" of the internal 2D reel label mentions "Lead Free Process"
 2. Letter L is system default code for order only
 3. AF series products are available by "Global part number" only



Chip Resistors Selection Charts

AF - Sulfur resistant chip resistors, Arrays

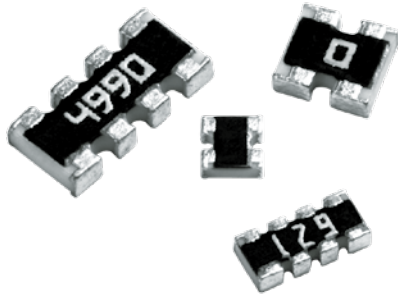

Features

- AEC-Q200 qualified
- Superior resistance against sulfur containing atmosphere
- Highly reliable electrode construction
- Compatible with all soldering processes
- Highly stable in auto-placement surface mounting applications
- Halogen free product and production

Schematics

AF122 /AF162

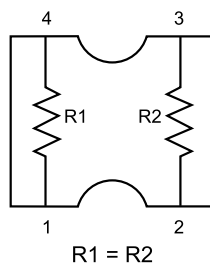

AF124 /AF164

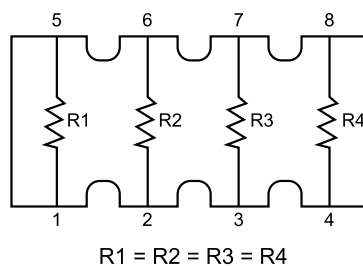

Dimensions

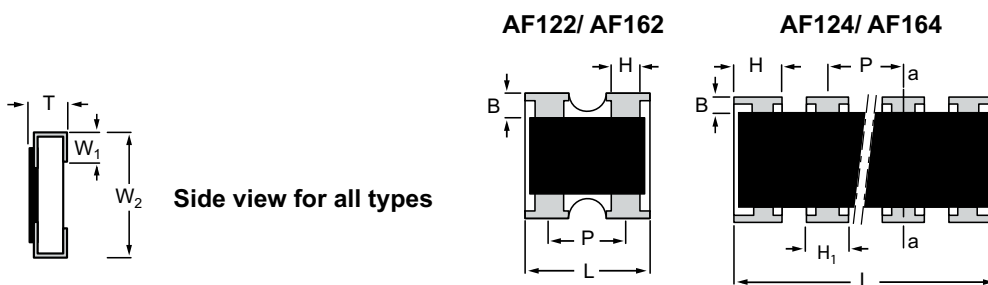

unit: mm

Type	H / H1	B	P	L	T	W1	W2
AF122	0.30 +0.10/-0.05	0.24 ± 0.10	0.67 ± 0.05	1.00 ± 0.10	0.30 ± 0.10	0.25 ± 0.10	1.00 ± 0.10
AF124	H : 0.45 ± 0.05 H1 : 0.30 ± 0.05	0.25 ± 0.15	0.50 ± 0.05	2.00 ± 0.10	0.45 ± 0.10	0.30 ± 0.15	1.00 ± 0.10
AF162	0.35 ± 0.10	0.30 ± 0.10	0.80 ± 0.05	1.6 ± 0.10	0.40 ± 0.10	0.30 ± 0.10	1.6 ± 0.10
AF164	H: 0.65 ± 0.05 H1: 0.50 ± 0.15	0.30 ± 0.15	0.80 ± 0.05	3.2 ± 0.15	0.60 ± 0.10	0.30 ± 0.15	1.6 ± 0.15





Chip Resistors Selection Charts

AF - Sulfur resistant chip resistors, Arrays

Electrical characteristics								
Type	Power rating	Operating Temp. range	MWV	RCOV	DWV	Resistance range & tolerance	T. C. R.	Jumper criteria (unit: A)
AF122	1/16W	-55°C to 155°C	50V	100V	100V	E24 ±5% 1Ω ≤ R ≤ 1MΩ E24/E96 ±1% 10Ω ≤ R ≤ 1MΩ Jumper < 50mΩ	1Ω ≤ R < 10Ω ±250 ppm/°C 10Ω ≤ R < 1MΩ ±200 ppm/°C	Rated current 0.5A Max. current 1.0A
AF124	1/16W		25V	50V	100V	E24 ±5% 1Ω ≤ R ≤ 1MΩ E24/E96 ±1% 1Ω ≤ R ≤ 1MΩ Jumper < 50mΩ	1Ω ≤ R < 10Ω ±250 ppm/°C 10Ω ≤ R < 1MΩ ±200 ppm/°C	Rated current 1.0A Max. current 2.0A
AF162	1/16W		50V	100V	100V	E24 ±5% 1Ω ≤ R ≤ 1MΩ E24/E96 ±1% 1Ω ≤ R ≤ 1MΩ Jumper < 50mΩ	1Ω ≤ R < 10Ω ±250 ppm/°C 10Ω ≤ R < 1MΩ ±200 ppm/°C	Rated current 1.0A Max. current 2.0A
AF164	1/16W		50V	100V	100V	E24 ±5% 1Ω ≤ R ≤ 1MΩ E24/E96 ±1% 1Ω ≤ R ≤ 1MΩ Jumper < 50mΩ	±250 ppm/°C	Rated current 1.0A Max. current 2.0A

Environmental characteristics			
Performance test	Test method	Procedure	Requirements
Life	MIL-STD-202 -method 108	1000 hours at 70 ±5°C applied RCWV 1.5 hours on, 0.5 hours off, still air required	± (2% +50mΩ) < 100mΩ for jumper
High temperature exposure	MIL-STD-202 -method 108	1000 hours at maximum operating temperature depending on specification, unpowered No direct impingement of forced air to the parts Tolerances: 125±3°C	± (1% +50mΩ) < 50mΩ for jumper
Moisture resistance	MIL-STD-202 -method 106	Each temperature / humidity cycle is defined as 8 hours (method 106F), 3 cycles / 24 hours for 10d with 25°C / 65°C 95% R.H	± (2% +50mΩ) < 50mΩ for jumper
Thermal shock	MIL-STD-202 -method 107	-55 / +125°C Note: Number of cycles required is 300. Devices mounted Maximum transfer time is 20 seconds. Dwell time is 15 minutes. Air – Air	± (1% +50mΩ) for others < 50mΩ for jumper
Solderability	Wetting	J-STD-002B test B Electrical test not required. Magnification 50X Lead-free solder bath at 245 ±3°C Dipping time: 3 ±0.5 seconds	Well tinned (≥ 95% covered)
	Resistance to soldering heat	MIL-STD-202 Method 210 Lead-free solder, 260°C, 10 seconds immersion time	± (1% +50mΩ) < 50mΩ for jumper No visible damage
Short time overload	IEC60115-1 4.13	2.5 times RCWV or maximum overload voltage whichever is less for 5 seconds at room temperature	± (2% +50mΩ) < 50mΩ for jumper No visible damage
FOS	ASTM-B-809-95* *Modified	Sulfur 750 hours, 105°C, Rating with no power	± (4% +50mΩ)



Chip Resistors Selection Charts

AF - Sulfur resistant chip resistors, Arrays

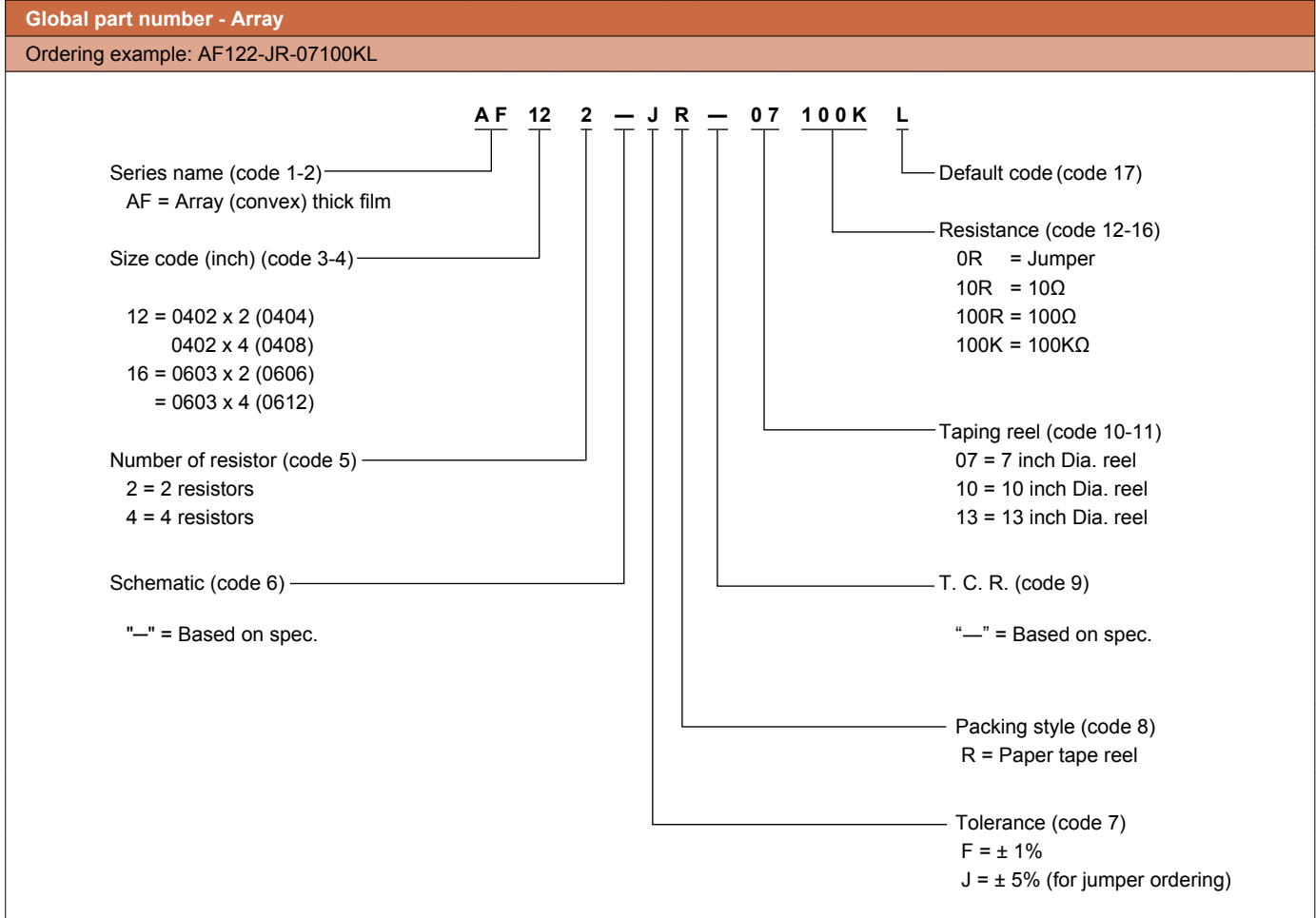

Note: 1. All our RSMD products meet RoHS Compliant. "LFP" of the internal 2D reel label mentions "Lead Free Process"
2. Letter L is system default code for order only



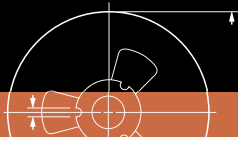

Chip Resistors Selection Charts

AA - Automotive grade sulfur-resistant chip resistors, 0201 to 2512

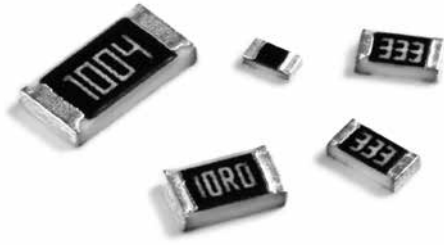

Features

- AEC-Q200 qualified
- Production part approval process (PPAP) support
- High reliability
- High quality level

Derating curve	Construction
<p>Maximum dissipation (P) in percentage of rated power as a function of the operating ambient temperature (T_{amb}).</p> <p>A line graph with 'Rated Power (%)' on the y-axis (0 to 100) and 'Ambient Temperature (°C)' on the x-axis (-55 to 160). A horizontal line is at 100% until 70°C. From 70°C, a line slopes down to 15% at 155°C.</p>	<p>A cross-sectional diagram of a chip resistor. Labels from top to bottom: marking layer, overcoat, protective glass, resistive layer (Jumper chip is a conductor), inner electrode, termination (Ni/matte tin), inner electrode, and ceramic substrate.</p>

Dimensions			
AA0201/0402	AA0603/0805/1206 1210/2010/2512	AA1218	Side view for all type

unit: mm

Type	L	W	H	l_1	l_2
AA0201	0.60 ± 0.03	0.30 ± 0.03	0.23 ± 0.03	0.12 ± 0.05	0.15 ± 0.05
AA0402	1.00 ± 0.05	0.50 ± 0.05	0.32 ± 0.05	0.20 ± 0.10	0.25 ± 0.10
AA0603	1.60 ± 0.10	0.80 ± 0.10	0.45 ± 0.10	0.25 ± 0.15	0.25 ± 0.15
AA0805	2.00 ± 0.10	1.25 ± 0.10	0.50 ± 0.10	0.35 ± 0.20	0.35 ± 0.20
AA1206	3.10 ± 0.10	1.60 ± 0.10	0.55 ± 0.10	0.45 ± 0.20	0.40 ± 0.20
AA1210	3.10 ± 0.10	2.60 ± 0.15	0.55 ± 0.10	0.45 ± 0.15	0.50 ± 0.20
AA1218	3.10 ± 0.10	4.60 ± 0.10	0.55 ± 0.10	0.45 ± 0.20	0.40 ± 0.20
AA2010	5.00 ± 0.10	2.50 ± 0.15	0.55 ± 0.10	0.55 ± 0.15	0.50 ± 0.20
AA2512	6.35 ± 0.10	3.10 ± 0.15	0.55 ± 0.10	0.60 ± 0.20	0.50 ± 0.20



Chip Resistors Selection Charts

AA - Automotive grade sulfur-resistant chip resistors, 0201 to 2512

Electrical characteristics								
Type	Power P_{70}	Operating Temp. range	MWV	RCOV	DWV	Resistance range & tolerance	T. C. R. (ppm/°C)	Jumper criteria (unit: A)
AA0201	1/20W	-55°C to 155°C	25V	50V	50V	E24 ±5% $1\Omega \leq R \leq 10M\Omega$ E24/E96 ±0.5%,±1% $1\Omega \leq R \leq 10M\Omega$ Jumper < 50mΩ	$1\Omega \leq R \leq 10\Omega$ -100/ ±400 ppm/°C $10\Omega < R \leq 10M\Omega$ ±300 ppm/°C	Rated Current 0.5A Max. Current 1.0A
AA0402	1/16W		50V	100V	100V	E24 ±5% $1\Omega \leq R \leq 22M\Omega$ E24/E96 ±0.5%,±1% $1\Omega \leq R \leq 10M\Omega$ Jumper < 50mΩ	$1\Omega \leq R \leq 10\Omega$ ±200 ppm/°C $10\Omega < R \leq 10M\Omega$ ±150 ppm/°C $10M\Omega < R \leq 22M\Omega$ ±200 ppm/°C	Rated Current 1A Max. Current 2A
AA0603	1/10W		75V	150V	150V			Rated Current 1A Max. Current 2A
AA0805	1/8W		150V	300V	300V			Rated Current 2A Max. Current 5A
AA1206	1/4W		200V	400V	500V	E24 ±5% $1\Omega \leq R \leq 1M\Omega$ E24/E96 ±0.5%,±1% $1\Omega \leq R \leq 1M\Omega$ Jumper < 50mΩ	$1\Omega \leq R \leq 10\Omega$ ±200 ppm/°C $10\Omega < R \leq 10M\Omega$ ±150 ppm/°C $10M\Omega < R \leq 22M\Omega$ ±200 ppm/°C	Rated Current 2A Max. Current 10A
AA1210	1/2W		200V	500V	500V			Rated Current 2A Max. Current 10A
AA1218	1W		200V	500V	500V	E24 ±5% $1\Omega \leq R \leq 22M\Omega$ E24/E96 ±0.5%,±1% $1\Omega \leq R \leq 10M\Omega$ Jumper < 50mΩ	$1\Omega \leq R \leq 10\Omega$ ±200 ppm/°C $10\Omega < R \leq 10M\Omega$ ±150 ppm/°C $10M\Omega < R \leq 22M\Omega$ ±200 ppm/°C	Rated Current 6A Max. Current 10A
AA2010	3/4W		200V	500V	500V			Rated Current 2A Max. Current 10A
AA2512	1W		200V	500V	500V			Rated Current 2A Max. Current 10A

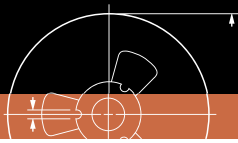

Chip Resistors Selection Charts

AA - Automotive grade sulfur-resistant chip resistors, 0201 to 2512

Environmental characteristics				
Performance test		Test method	Procedure	Requirements
Life		AEC-Q200 Test 8 MIL-STD-202 Method 108	1000 hours at 125°C applied RCWV 1.5 hours on, 0.5 hours off	± (1% +50mΩ) < 100mΩ for jumper
High temperature exposure		AEC-Q200 Test 3 MIL-STD-202 Method 108	1000 hours at maximum operating temperature depending on specification	± (1% +50mΩ) < 50mΩ for jumper
Moisture resistance		AEC-Q200 Test 6 MIL-STD-202 Method 106	Each temperature / humidity cycle is defined as 8 hours (method 106F), 3 cycles / 24 hours for 10d with 25°C / 65°C 95% R.H.	± (0.5% +50mΩ) for 1% tol. ± (2% +50mΩ) for 5% tol. < 100mΩ for jumper
Biased humidity		AEC-Q200 Test 7 MIL-STD-202 Method 103	1000 hours; + 85°C 85% R.H.; 10% of operating power Measured at 24 ±2 hours after test	± (3% +50mΩ) < 100mΩ for jumper
Thermal shock		AEC-Q200 Test 16 MIL-STD-202 Method 107	-55 / +125°C Number of cycles is 300. Devices mounted Maximum transfer time is 20 seconds. Dwell time is 15 minutes. Air – Air	± (1% +50mΩ) < 50mΩ for jumper
Solderability	Wetting	AEC-Q200 Test 18 J-STD-002B test B	Electrical test not required. Magnification 50X Lead-free solder bath at 245 ±3°C Dipping time: 3 ±0.5 seconds	Well tinned (≥ 95% covered) No visible damage
	Resistance to soldering heat	AEC-Q200 Test 15 MIL-STD-202 Method 210	Lead-free solder, 260°C, 10 seconds immersion time	± (0.5%+50mΩ) for 1% tol. ± (1%+50mΩ) for 5% tol. < 50 mΩ for Jumper No visible damage
Short time overload		IEC60115-1 4.13	2.5 times RCWV or maximum overload voltage whichever is less for 5 seconds at room temperature	± (1%+50mΩ) < 50 mΩ for Jumper
FOS		ASTM-B-809-95	Sulfur (saturated vapor) 1000 hours, 90±2°C, Rating with no power	± (1%+50mΩ)
		ASTM-B-809-95* * Modified	Sulfur 750 hours, 105°C, Rating with no power	± (4%+50mΩ)

Global part number - Preferred type

Ordering example: AA0603JR-07100KL

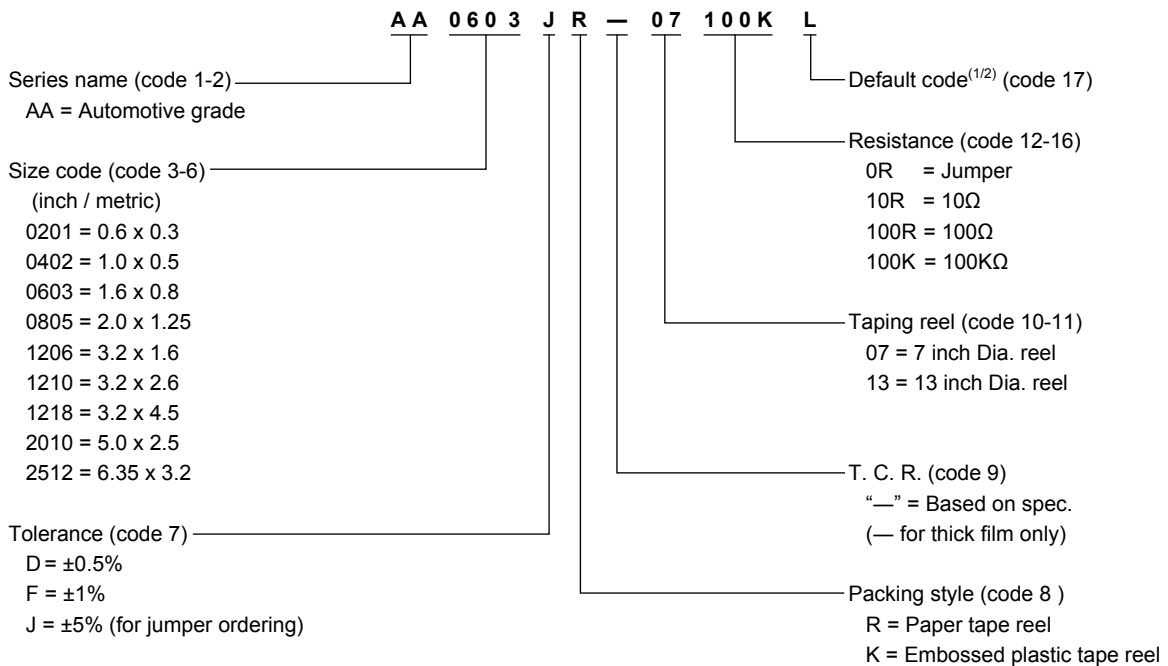

Note: 1. All of our RSMD products are RoHS compliant. "LFP" of the internal 2D reel label mentions "Lead Free Process"
 2. Letter L is system default code for ordering only
 3. AA series products are available by "Global part number" only



Chip Resistors Selection Charts

SR - Surge chip resistors, 0402 to 2512



Features

- AEC-Q200 qualified
- Higher component and equipment reliability
- Excellent performance at pulse loading

Derating curve

Maximum dissipation (P) in percentage of rated power as a function of the operating ambient temperature (T_{amb}).

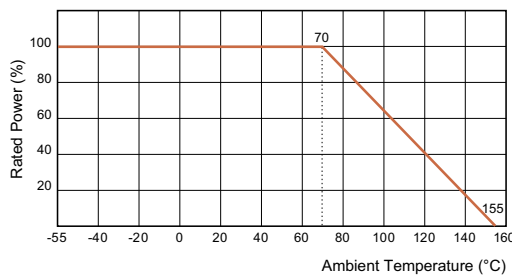

Construction

All size range except SR2512 with D/F tol

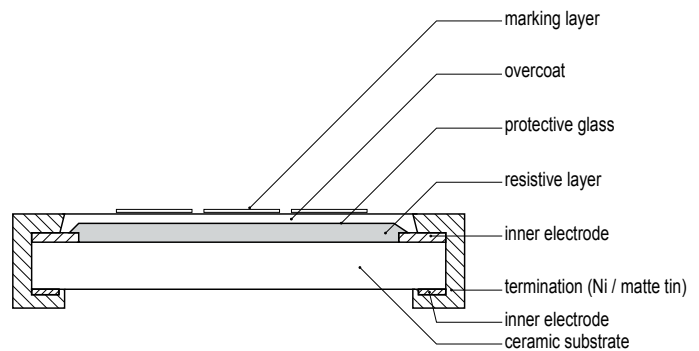

SR1206 (1W) & SR2512 (D/F tol)

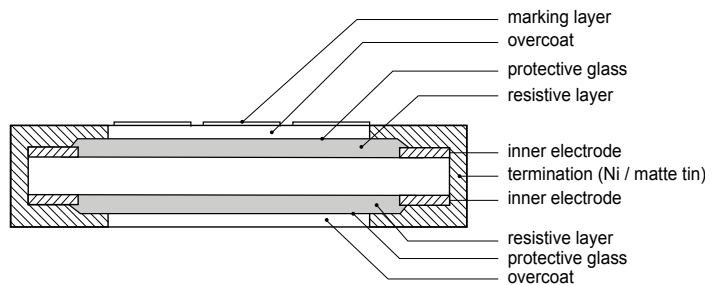

Dimensions

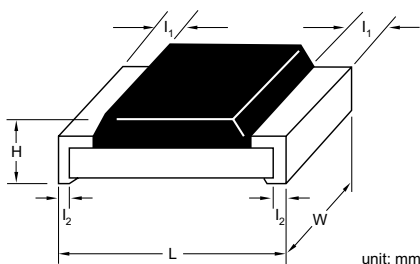

unit: mm

Type	L	W	H	l_1	l_2
SR0402	1.00 ± 0.05	0.50 ± 0.05	0.35 ± 0.05	0.20 ± 0.10	0.25 ± 0.10
SR0603	1.60 ± 0.10	0.80 ± 0.10	0.45 ± 0.10	0.25 ± 0.15	0.25 ± 0.15
SR0805	2.00 ± 0.10	1.25 ± 0.10	0.50 ± 0.10	0.35 ± 0.20	0.35 ± 0.20
SR1206	3.10 ± 0.10	1.60 ± 0.10	0.55 ± 0.10	0.45 ± 0.20	0.40 ± 0.20
SR1210	3.10 ± 0.10	2.60 ± 0.15	0.55 ± 0.10	0.45 ± 0.15	0.50 ± 0.20
SR1218	3.10 ± 0.10	4.60 ± 0.10	0.55 ± 0.10	0.45 ± 0.20	0.40 ± 0.20
SR2010	5.00 ± 0.10	2.50 ± 0.15	0.55 ± 0.10	0.55 ± 0.15	0.50 ± 0.20
SR2512	6.35 ± 0.10	3.10 ± 0.15	0.55 ± 0.10	0.60 ± 0.20	0.50 ± 0.20



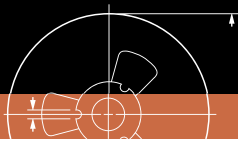

Chip Resistors Selection Charts

SR - Surge chip resistors, 0402 to 2512

Electrical characteristics								
Type	Power P ₇₀	Operating Temp. range	MWV	RCOV	DWV	Resistance range & tolerance	T. C. R.	
SR0402	1/16W	-55°C to +155°C	50V	100V	100V	E24 ±0.5%, ±1%, ±5%, ±10%, ±20% E96 ±0.5%, ±1%	1Ω ≤ R ≤ 1MΩ	±200 ppm/°C
	1/8W							
	1/5W							
SR0603	1/10W		75V	150V	150V			
	1/5W							
SR0805	1/4W		150V	300V	300V			
	1/8W							
	1/3W							
SR1206	1/2W		200V	400V	500V			
	1/4W							
	3/4W							
	1W							
SR1210	1/2W	200V	400V	500V				
	1W							
SR1218	1W	200V	400V	500V				
	1.5W							
SR2010	3/4W	200V	400V	500V				
	1.25W							
SR2512	1W	200V	400V	500V				
	2W							

Environmental characteristics				
Performance test	Test method	Procedure	Requirements	
Life	MIL-STD-202 -method 108	1000 hours at 70 ±2°C applied RCWV 1.5 hours on, 0.5 hours off, still air required	± (3% +50mΩ)	
High temperature exposure	IEC 60068-2-2	1000 hours at maximum operating temperature depending on specification, unpowered	± (3% +50mΩ)	
Solderability	Wetting	J-STD-002B test B	Electrical test not required. Magnification 50X Lead-free solder bath at 245 ±3°C Dipping time: 3 ±0.5 seconds	Well tinned (≥ 95% covered) No visible damage
	Resistance to soldering heat	MIL-STD-202 -method 210F	Lead-free solder, 260°C, 10 seconds immersion time	± (1% +50mΩ) No visible damage
Short time overload	IEC60115-1 4.13	2.5 times RCWV or maximum overload voltage whichever is less for 5 seconds at room temperature	± (2% +50mΩ) No visible damage	

Pulse-Load behavior	
±5%, ±10%, ±20%	±0.5%, ±1%

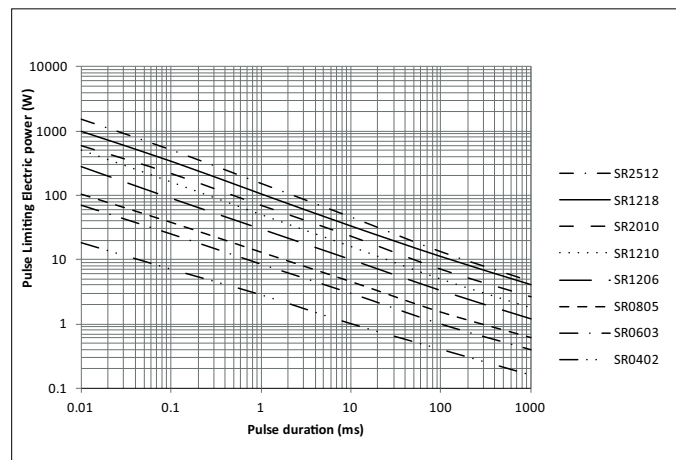
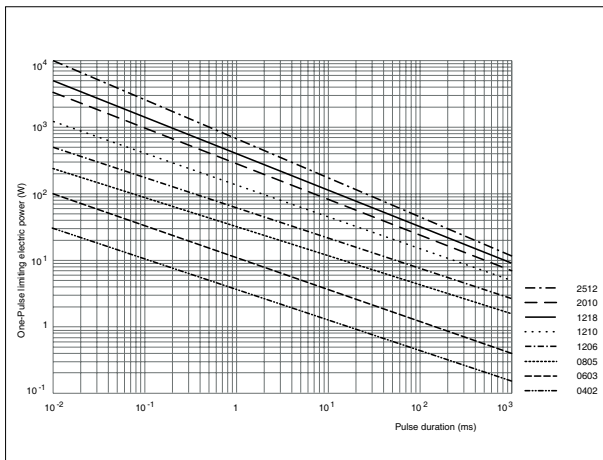

Chip Resistors Selection Charts

SR - Surge chip resistors, 0402 to 2512

Global part number - Preferred type for ordering Yageo / Phycomp branded products

Ordering example: SR0805MR-07100KL

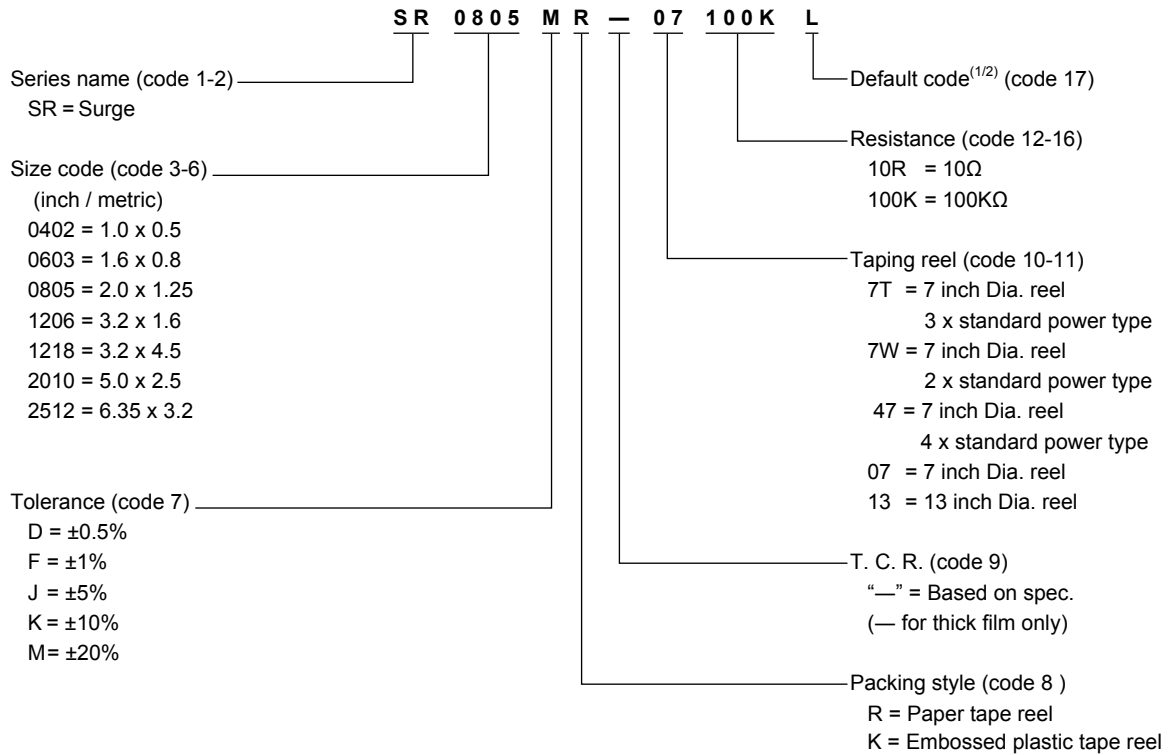

Note: 1. All of our RSMD products are RoHS compliant. "LFP" of the internal 2D reel label mentions "Lead Free Process"
 2. Letter L is system default code for ordering only

Phycomp worldwide - Traditional type

Surge chip resistors						
Size: inch (mm)	0805 (2012)	1206 (3216)	1218 (3248)	2512 (6432)		
Power	1/8 W	1/4 W	1 W	1 W		
Tolerance	+10%	+5%	+10%	+5%	+10%	+20%
Resistance	E24	E24	E24	E24	E24	E24
Packing	paper tape	paper tape	paper tape	paper tape	paper tape	paper tape
Quantity	4 000	---	2350 557 10...L	2350 556 11...L	2350 556 10...L	2350 556 13...L
	5 000	2350 554 12...L	2350 550 10...L	---	---	---

For ordering rules: See page 14 for E24 / E96 values and the last 4 or 3 digits of the 12NC catalogue number



Chip Resistors Selection Charts

RV - High voltage chip resistors, 0603 to 2512



Features

- Higher maximum working voltage compared to RC series
- Safety certificate IEC62368-1 G.10.2 (2.5kV impulse)
compliance: RV0603 (100K ~ 10MΩ)
RV0805 (100K ~ 22MΩ)
RV1206 (100K ~ 27MΩ)
- Compatible with lead containing and lead-free soldering processes
- Highly stable in auto-placement surface mounting

Derating curve	Construction										
<p>Maximum dissipation (P) in percentage of rated power as a function of the operating ambient temperature (T_{amb}).</p> <table border="1"> <caption>Derating Curve Data</caption> <thead> <tr> <th>Ambient Temperature (°C)</th> <th>Rated Power (%)</th> </tr> </thead> <tbody> <tr><td>-55</td><td>100</td></tr> <tr><td>0</td><td>100</td></tr> <tr><td>70</td><td>100</td></tr> <tr><td>155</td><td>15</td></tr> </tbody> </table>	Ambient Temperature (°C)	Rated Power (%)	-55	100	0	100	70	100	155	15	
Ambient Temperature (°C)	Rated Power (%)										
-55	100										
0	100										
70	100										
155	15										

Dimensions																																					
<p style="text-align: right;">unit: mm</p>	<table border="1"> <thead> <tr> <th>Type</th> <th>L</th> <th>W</th> <th>H</th> <th>l_1</th> <th>l_2</th> </tr> </thead> <tbody> <tr> <td>RV0603</td> <td>1.60 ± 0.10</td> <td>0.80 ± 0.10</td> <td>0.45 ± 0.10</td> <td>0.25 ± 0.15</td> <td>0.25 ± 0.15</td> </tr> <tr> <td>RV0805</td> <td>2.00 ± 0.10</td> <td>1.25 ± 0.10</td> <td>0.50 ± 0.10</td> <td>0.35 ± 0.20</td> <td>0.35 ± 0.20</td> </tr> <tr> <td>RV1206</td> <td>3.10 ± 0.10</td> <td>1.60 ± 0.10</td> <td>0.55 ± 0.10</td> <td>0.40 ± 0.20</td> <td>0.45 ± 0.20</td> </tr> <tr> <td>RV2010</td> <td>5.00 ± 0.10</td> <td>2.50 ± 0.15</td> <td>0.55 ± 0.10</td> <td>0.45 ± 0.15</td> <td>0.50 ± 0.20</td> </tr> <tr> <td>RV2512</td> <td>6.35 ± 0.10</td> <td>3.10 ± 0.15</td> <td>0.55 ± 0.10</td> <td>0.60 ± 0.20</td> <td>0.50 ± 0.20</td> </tr> </tbody> </table>	Type	L	W	H	l_1	l_2	RV0603	1.60 ± 0.10	0.80 ± 0.10	0.45 ± 0.10	0.25 ± 0.15	0.25 ± 0.15	RV0805	2.00 ± 0.10	1.25 ± 0.10	0.50 ± 0.10	0.35 ± 0.20	0.35 ± 0.20	RV1206	3.10 ± 0.10	1.60 ± 0.10	0.55 ± 0.10	0.40 ± 0.20	0.45 ± 0.20	RV2010	5.00 ± 0.10	2.50 ± 0.15	0.55 ± 0.10	0.45 ± 0.15	0.50 ± 0.20	RV2512	6.35 ± 0.10	3.10 ± 0.15	0.55 ± 0.10	0.60 ± 0.20	0.50 ± 0.20
Type	L	W	H	l_1	l_2																																
RV0603	1.60 ± 0.10	0.80 ± 0.10	0.45 ± 0.10	0.25 ± 0.15	0.25 ± 0.15																																
RV0805	2.00 ± 0.10	1.25 ± 0.10	0.50 ± 0.10	0.35 ± 0.20	0.35 ± 0.20																																
RV1206	3.10 ± 0.10	1.60 ± 0.10	0.55 ± 0.10	0.40 ± 0.20	0.45 ± 0.20																																
RV2010	5.00 ± 0.10	2.50 ± 0.15	0.55 ± 0.10	0.45 ± 0.15	0.50 ± 0.20																																
RV2512	6.35 ± 0.10	3.10 ± 0.15	0.55 ± 0.10	0.60 ± 0.20	0.50 ± 0.20																																



Chip Resistors Selection Charts

RV - High voltage chip resistors, 0603 to 2512

Electrical characteristics							
Type	Power P ₇₀	Operating Temp. range	MWV	RCOV	DWV	Resistance range & tolerance	T. C. R.
RV0603	1/10W	-55°C to +155°C	350V	500V	500V	E24 ±5% E24/E96 ±1% 47Ω ≤ R ≤ 10MΩ E24/E96 ±0.5%	47Ω ≤ R ≤ 10MΩ ±100 ppm/°C 10MΩ < R ≤ 22MΩ ±200 ppm/°C
RV0805	1/8W		400V	800V	800V	E24 ±5% 47Ω ≤ R ≤ 22MΩ E24/E96 ±1% 47Ω ≤ R ≤ 22MΩ E24/E96 ±0.5% 47Ω ≤ R ≤ 10MΩ	
RV1206	1/4W		500V	1000V	1000V	E24 ±5% 47Ω ≤ R ≤ 27MΩ E24/E96 ±1% 47Ω ≤ R ≤ 27MΩ E24/E96 ±0.5% 47Ω ≤ R ≤ 15MΩ	
RV2010	3/4W		500V	1000V	1000V	E24 ±5% 47Ω ≤ R ≤ 22MΩ E24/E96 ±1% 47Ω ≤ R ≤ 22MΩ E24/E96 ±0.5% 47Ω ≤ R ≤ 10MΩ	
RV2512	1W		500V	1000V	1000V	E24 ±5% 47Ω ≤ R ≤ 16MΩ E24/E96 ±1% 47Ω ≤ R ≤ 16MΩ E24/E96 ±0.5% 47Ω ≤ R ≤ 10MΩ	

Environmental characteristics			
Performance test	Test method	Procedure	Requirements
Life	MIL-STD-202 Method 108A	1000 hours at 70 ±2°C applied RCWV 1.5 hours on, 0.5 hours off, still air required	± (2% +50mΩ)
High temperature exposure	MIL-STD-202 Method 108A	1000 hours at maximum operating temperature depending on specification, unpowered	± (1% +50mΩ)
Moisture resistance	MIL-STD-202 Method 106G	Each temperature / humidity cycle is defined as 8 hours (method 106G), 3 cycles / 24 hours for 10d with 25°C / 65°C 95% R.H	± (2% +50mΩ)
Thermal shock	MIL-STD-202 Method 107G	-55 / +125°C Note: Number of cycles required is 300. Devices mounted Maximum transfer time is 20 seconds. Dwell time is 15 minutes. Air – Air	± (0.5% +50mΩ) for 10K to 10M ± (1% +50mΩ) for others
Solderability	Wetting	IEC 60115 -1 4.13 Electrical test not required. Magnification 50X Lead-free solder bath at 245 ±3°C Dipping time: 3 ±0.5 seconds	Well tinned (≥ 95% covered) No visible damage
	Resistance to soldering heat	MIL-STD-202 method 210F Lead-free solder, 260°C, 10 seconds immersion time	± (1% +50mΩ) No visible damage
Short time overload	J-STD-002B test B	2.5 times RCWV or maximum overload voltage whichever is less for 5 seconds at room temperature	± (2% +50mΩ) No visible damage

Chip Resistors Selection Charts

CP - Cooper termination chip resistor, 0201



Features

- This product with lead free terminations meet RoHS requirements.
- Excellent bending strength
- High reliability
- High component and equipment reliability
- Saving of PCB space
- Better thermal conductivity

Derating curve	Construction										
<p>Maximum dissipation (P) in percentage of rated power as a function of the operating ambient temperature (T_{amb}).</p> <table border="1"> <caption>Derating Curve Data</caption> <thead> <tr> <th>Ambient Temperature (°C)</th> <th>Rated Power (%)</th> </tr> </thead> <tbody> <tr><td>-55</td><td>100</td></tr> <tr><td>0</td><td>100</td></tr> <tr><td>70</td><td>100</td></tr> <tr><td>125</td><td>0</td></tr> </tbody> </table>	Ambient Temperature (°C)	Rated Power (%)	-55	100	0	100	70	100	125	0	<p>Labels in diagram:</p> <ul style="list-style-type: none"> Overcoat Primary glass layer Resistive layer Inner electrode Sputtered conductor layer Termination (Cu) Inner electrode Ceramic substrate <p>Dimensions: H (height), l₂ (width of termination)</p>
Ambient Temperature (°C)	Rated Power (%)										
-55	100										
0	100										
70	100										
125	0										

Dimensions												
<p>unit: mm</p> <table border="1"> <thead> <tr> <th>Type</th> <th>L</th> <th>W</th> <th>H</th> <th>l₁</th> <th>l₂</th> </tr> </thead> <tbody> <tr> <td>CP0201</td> <td>0.60 ± 0.03</td> <td>0.30 ± 0.03</td> <td>0.27 ± 0.03</td> <td>>0.05</td> <td>>0.2</td> </tr> </tbody> </table>	Type	L	W	H	l ₁	l ₂	CP0201	0.60 ± 0.03	0.30 ± 0.03	0.27 ± 0.03	>0.05	>0.2
Type	L	W	H	l ₁	l ₂							
CP0201	0.60 ± 0.03	0.30 ± 0.03	0.27 ± 0.03	>0.05	>0.2							

Electrical characteristics							
Type	Power P70	Operating Temp. range	MWV	RCOV	DWV	Resistance range	T.C.R
CP0201	1/20W	-55°C to 125°C	25V	50V	50V	E24/96 ±1%, ±5% 10Ω~1MΩ	±200 ppm/°C

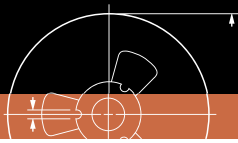

Chip Resistors Selection Charts

CP - Cooper termination chip resistor, 0201

Environmental characteristics				
Performance test		Test method	Procedure	Requirements
Life		MIL-STD-202 -method 108A	1000 hours at 70 ±2°C applied RCWV 1.5 hours on, 0.5 hours off, still air required	±(1%+50mΩ) for F tol. ±(3%+50mΩ) for J tol.
High temperature exposure		MIL-STD-202 -method 108A	1000 hours at maximum operating temperature depending on specification, unpowered	±(1%+50mΩ)
Rapid change of temperature		MIL-STD-202 Method 107	-55/+125°C Note Number of cycles required is 100 Devices Maximum transfer time is 20 seconds Dwell time is 30 minutes. Air - Air	±(1%+50mΩ)
Terminal Strength (SMD)		AEC-Q200 Test 22 AEC-Q200-006	Force of 5N for 0201, The force applied for 10±1 seconds.	± (1% +50mΩ) No visible damage
Solderability	Wetting	IPC/JEDECJ-STD-002B test B	Electrical test not required. Magnification 50X Lead-free solder bath at 245 ±3°C Dipping time: 3 ±0.5 seconds	Well tinned (≥ 95% covered) No visible damage
	Resistance to soldering heat	MIL-STD-202 -method 210F	Lead-free solder, 260°C, 10 seconds immersion time	± (0.5%+ 50mΩ) No visible damage
Short time overload		IEC 60115 -1 4.13	2.5 times RCWV or maximum overload voltage whichever is less for 5 seconds at room temperature	± (1%+ 50mΩ) No visible damage

Global part number - Preferred type for ordering Yageo / Phycomp branded products

Ordering example: CP0201FR-07100KL

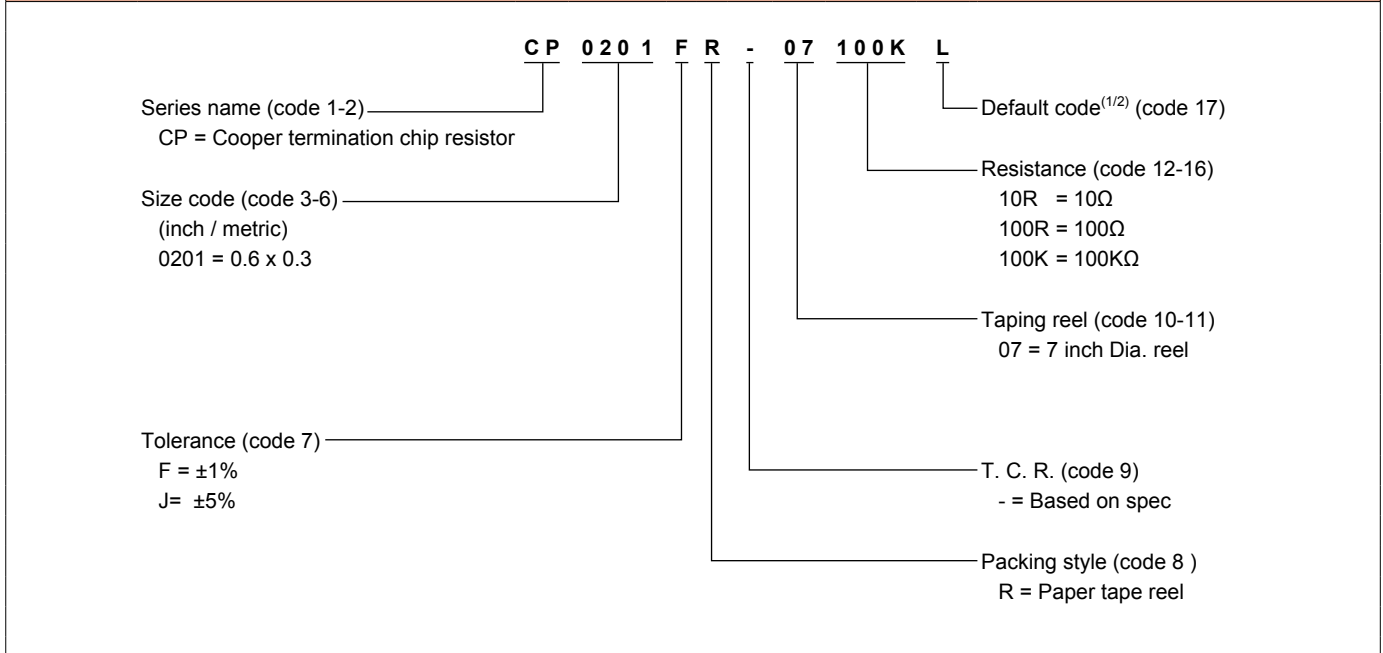

Note: 1. All of our RSMD products are RoHS compliant. "LFP" of the internal 2D reel label mentions "Lead Free Process"
 2. Letter L is system default code for ordering only
 3. CP series products are available by "Global part number" only



Chip Resistors Selection Charts

RT - Thin film high precision high stability chip resistors, 0201 to 2512



Features

- High precision - High stability
- Low T. C. R. / low noise
- High accuracy ($\pm 0.01\%$, $\pm 0.02\%$, $\pm 0.05\%$, $\pm 0.1\%$, $\pm 0.25\%$, $\pm 0.5\%$, $\pm 1\%$)

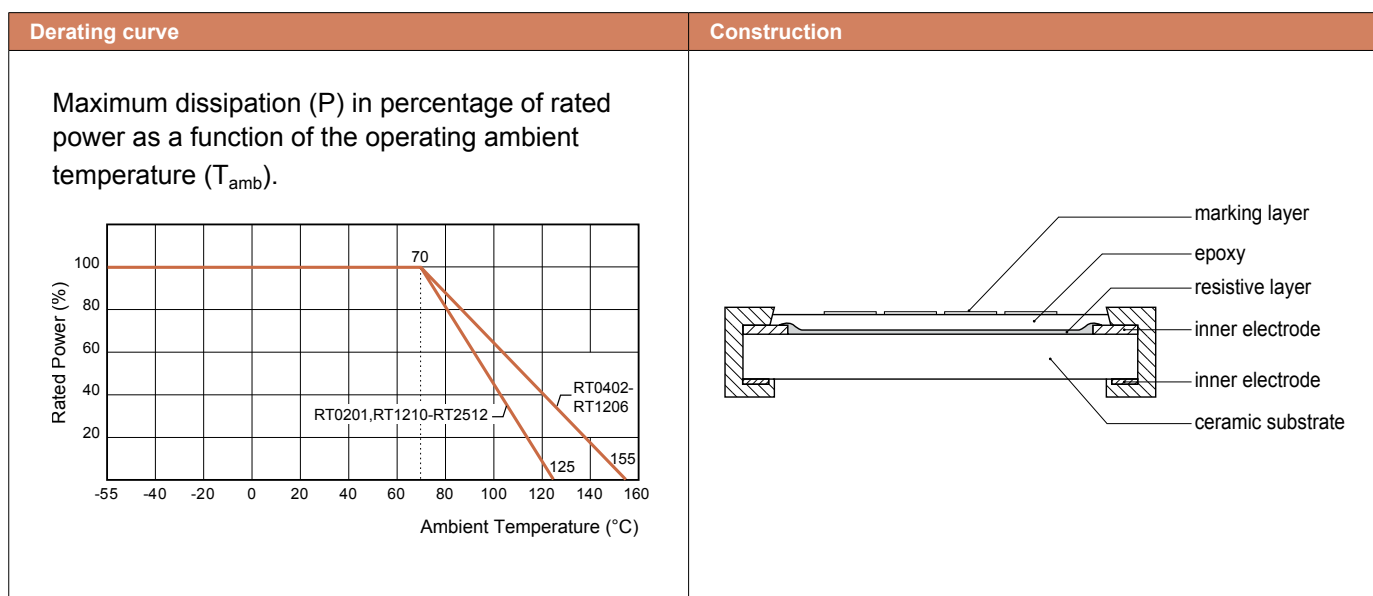

Dimensions																																																							
<p>unit: mm</p>	<table border="1"> <thead> <tr> <th>Type</th> <th>L</th> <th>W</th> <th>H</th> <th>l_1</th> <th>l_2</th> </tr> </thead> <tbody> <tr> <td>RT0201</td> <td>0.60 ± 0.03</td> <td>0.30 ± 0.03</td> <td>0.23 ± 0.03</td> <td>0.10 ± 0.05</td> <td>0.15 ± 0.05</td> </tr> <tr> <td>RT0402</td> <td>1.00 ± 0.10</td> <td>0.50 ± 0.05</td> <td>0.30 ± 0.05</td> <td>0.20 ± 0.10</td> <td>0.25 ± 0.10</td> </tr> <tr> <td>RT0603</td> <td>1.60 ± 0.10</td> <td>0.80 ± 0.10</td> <td>0.45 ± 0.10</td> <td>0.25 ± 0.15</td> <td>0.25 ± 0.15</td> </tr> <tr> <td>RT0805</td> <td>2.00 ± 0.10</td> <td>1.25 ± 0.10</td> <td>0.50 ± 0.10</td> <td>0.35 ± 0.20</td> <td>0.35 ± 0.20</td> </tr> <tr> <td>RT1206</td> <td>3.10 ± 0.10</td> <td>1.60 ± 0.10</td> <td>0.55 ± 0.10</td> <td>0.45 ± 0.20</td> <td>0.40 ± 0.20</td> </tr> <tr> <td>RT1210</td> <td>3.10 ± 0.10</td> <td>2.60 ± 0.15</td> <td>0.55 ± 0.10</td> <td>0.50 ± 0.20</td> <td>0.50 ± 0.20</td> </tr> <tr> <td>RT2010</td> <td>5.00 ± 0.10</td> <td>2.50 ± 0.15</td> <td>0.55 ± 0.10</td> <td>0.60 ± 0.20</td> <td>0.50 ± 0.20</td> </tr> <tr> <td>RT2512</td> <td>6.35 ± 0.10</td> <td>3.20 ± 0.15</td> <td>0.55 ± 0.10</td> <td>0.60 ± 0.20</td> <td>0.50 ± 0.20</td> </tr> </tbody> </table>	Type	L	W	H	l_1	l_2	RT0201	0.60 ± 0.03	0.30 ± 0.03	0.23 ± 0.03	0.10 ± 0.05	0.15 ± 0.05	RT0402	1.00 ± 0.10	0.50 ± 0.05	0.30 ± 0.05	0.20 ± 0.10	0.25 ± 0.10	RT0603	1.60 ± 0.10	0.80 ± 0.10	0.45 ± 0.10	0.25 ± 0.15	0.25 ± 0.15	RT0805	2.00 ± 0.10	1.25 ± 0.10	0.50 ± 0.10	0.35 ± 0.20	0.35 ± 0.20	RT1206	3.10 ± 0.10	1.60 ± 0.10	0.55 ± 0.10	0.45 ± 0.20	0.40 ± 0.20	RT1210	3.10 ± 0.10	2.60 ± 0.15	0.55 ± 0.10	0.50 ± 0.20	0.50 ± 0.20	RT2010	5.00 ± 0.10	2.50 ± 0.15	0.55 ± 0.10	0.60 ± 0.20	0.50 ± 0.20	RT2512	6.35 ± 0.10	3.20 ± 0.15	0.55 ± 0.10	0.60 ± 0.20	0.50 ± 0.20
Type	L	W	H	l_1	l_2																																																		
RT0201	0.60 ± 0.03	0.30 ± 0.03	0.23 ± 0.03	0.10 ± 0.05	0.15 ± 0.05																																																		
RT0402	1.00 ± 0.10	0.50 ± 0.05	0.30 ± 0.05	0.20 ± 0.10	0.25 ± 0.10																																																		
RT0603	1.60 ± 0.10	0.80 ± 0.10	0.45 ± 0.10	0.25 ± 0.15	0.25 ± 0.15																																																		
RT0805	2.00 ± 0.10	1.25 ± 0.10	0.50 ± 0.10	0.35 ± 0.20	0.35 ± 0.20																																																		
RT1206	3.10 ± 0.10	1.60 ± 0.10	0.55 ± 0.10	0.45 ± 0.20	0.40 ± 0.20																																																		
RT1210	3.10 ± 0.10	2.60 ± 0.15	0.55 ± 0.10	0.50 ± 0.20	0.50 ± 0.20																																																		
RT2010	5.00 ± 0.10	2.50 ± 0.15	0.55 ± 0.10	0.60 ± 0.20	0.50 ± 0.20																																																		
RT2512	6.35 ± 0.10	3.20 ± 0.15	0.55 ± 0.10	0.60 ± 0.20	0.50 ± 0.20																																																		



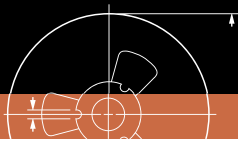

Chip Resistors Selection Charts

RT - Thin film high precision high stability chip resistors, 0201 to 2512

Electrical characteristics														
Type	Power P ₇₀	Operating Temp. range	MWV	RCOV	DWV	T.C.R. (ppm/°C)	Resistance Range (E24/E96) & tolerance							
							±0.01%	±0.02%	±0.05%	±0.1%	±0.25%	±0.5%	±1.0%	
RT0201	1/20W	-55°C to +125°C	25V	50V	50V	±50	---	---	---	22 ~75K	22 ~75K	22 ~75K	22 ~75K	
						±25	---	---	---	22~75K	22~75K	22~75K	22~75K	
						±15	---	---	---	22~5K	22~5K	22~5K	22~5K	
						±10	---	---	---	22~5K	22~5K	22~5K	22~5K	
						±5	---	---	---	---	---	---	---	
RT0402	1/16W	-55°C to +155°C	50V	100V	75V	±50	50.1~12K	50.1~12K	20~12K	4.7~240K	4.7~240K	4.7~240K	4.7~240K	
						±25	50.1~12K	50.1~12K	20~12K	4.7~240K	4.7~240K	4.7~240K	4.7~240K	
						±15	20~12K	20~12K	20~12K	20~200K	20~200K	20~200K	20~200K	
						±10	20~12K	20~12K	20~12K	20~200K	20~200K	20~200K	20~200K	
						±5	20~10K	20~10K	20~10K	20~10K	20~10K	---	---	
RT0603	1/10W		-55°C to +155°C	75V	150V	100V	±50	50.1~30K	50.1~30K	4.7~100K	1~1M	1~1M	1~1M	1~1M
							±25	50.1~30K	50.1~30K	4.7~100K	1~1M	1~1M	1~1M	1~1M
							±15	50.1~100K	50.1~100K	4.7~100K	4.7~680K	4.7~680K	4.7~680K	4.7~680K
							±10	50.1~100K	50.1~100K	4.7~100K	4.7~680K	4.7~680K	4.7~680K	4.7~680K
							±5	20~30K	20~30K	20~30K	20~30K	20~30K	---	---
RT0805	1/8W	-55°C to +155°C		150V	300V	200V	±50	50.1~30K	50.1~30K	4.7~200K	1~1.5M	1~1.5M	1~1.5M	1~1.5M
							±25	50.1~30K	50.1~30K	4.7~200K	1~1.5M	1~1.5M	1~1.5M	1~1.5M
							±15	50.1~200K	50.1~200K	4.7~200K	4.7~1M	4.7~1M	4.7~1M	4.7~1M
							±10	50.1~200K	50.1~200K	4.7~200K	4.7~1M	4.7~1M	4.7~1M	4.7~1M
							±5	20~50K	20~50K	20~50K	20~50K	20~50K	---	---
RT1206	1/4W		-55°C to +155°C	200V	400V	300V	±50	50.1~30K	50.1~30K	5.6~500K	1~1.5M	1~1.5M	1~1.5M	1~1.5M
							±25	50.1~30K	50.1~30K	5.6~500K	1~1.5M	1~1.5M	1~1.5M	1~1.5M
							±15	50.1~500K	50.1~500K	5.6~500K	5.6~1.5M	5.6~1.5M	5.6~1.5M	5.6~1.5M
							±10	50.1~500K	50.1~500K	5.6~500K	5.6~1.5M	5.6~1.5M	5.6~1.5M	5.6~1.5M
							±5	20~100K	20~100K	20~100K	20~100K	20~100K	---	---
RT1210	1/4W	-55°C to +155°C		200V	400V	400V	±50	---	---	4.7~1M	4.7~1M	4.7~1M	4.7~1M	4.7~1M
							±25	---	---	4.7~1M	4.7~1M	4.7~1M	4.7~1M	4.7~1M
							±15	---	---	100~100k	4.7~100k	4.7~100k	---	---
							±10	---	---	100~100k	4.7~100k	4.7~100k	---	---
							±5	---	---	---	---	---	---	---
RT2010	1/2W		-55°C to +125°C	200V	400V	400V	±50	---	---	4.7~1M	4.7~1M	4.7~1M	4.7~1M	4.7~1M
							±25	---	---	4.7~1M	4.7~1M	4.7~1M	4.7~1M	4.7~1M
							±15	---	---	100~100k	4.7~100k	4.7~100k	---	---
							±10	---	---	100~100k	4.7~100k	4.7~100k	---	---
							±5	---	---	---	---	---	---	---
RT2512	3/4W	-55°C to +125°C		200V	400V	400V	±50	---	---	4.7~1M	4.7~1M	4.7~1M	4.7~1M	4.7~1M
							±25	---	---	4.7~1M	4.7~1M	4.7~1M	4.7~1M	4.7~1M
							±15	---	---	100~100k	4.7~100k	4.7~100k	---	---
							±10	---	---	100~100k	4.7~100k	4.7~100k	---	---
							±5	---	---	---	---	---	---	---



Chip Resistors Selection Charts

RT - Thin film high precision high stability chip resistors, 0201 to 2512

Environmental characteristics				
Performance test	Test method	Procedure	Requirements	
Life	MIL-STD-202 Method 108A	1000 hours at 70 ±2°C applied RCWV 1.5 hours on, 0.5 hours off, still air required	±(0.5%+ 50mΩ)	
High temperature exposure	MIL-STD-202 Method 108A	1000 hours at maximum operating temperature depending on specification, unpowered	±(0.5%+ 50mΩ)	
Moisture resistance	MIL-STD-202 Method 106G	Each temperature / humidity cycle is defined as 8 hours (method 106G), 3 cycles / 24 hours for 10d with 25°C / 65°C 95% R.H	±(0.5%+ 50mΩ)	
Thermal shock	MIL-STD-202 Method 107G	-55 / +125°C Note: Number of cycles required is 300. Devices mounted Maximum transfer time is 20 seconds. Dwell time is 15 minutes. Air – Air	±(0.5%+ 50mΩ)	
Short time overload	IEC 60115-1 4.13	2.5 times RCWV or maximum overload voltage whichever is less for 5 seconds at room temperature	±(0.5%+ 50mΩ) No visible damage	
Solderability	Resistance to soldering heat	MIL-STD-202 method 210F	Lead-free solder, 260°C, 10 seconds immersion time	±(0.5%+ 50mΩ) No visible damage
	Wetting	J-STD-002B test B	Electrical test not required. Magnification 50X Lead-free solder bath at 245 ±3°C Dipping time: 3 ±0.5 seconds	Well tinned (≥ 95% covered) No visible damage

Global part number - Preferred type for ordering Yageo / Phycomp branded products

Ordering example: RT0603DRE07100KL

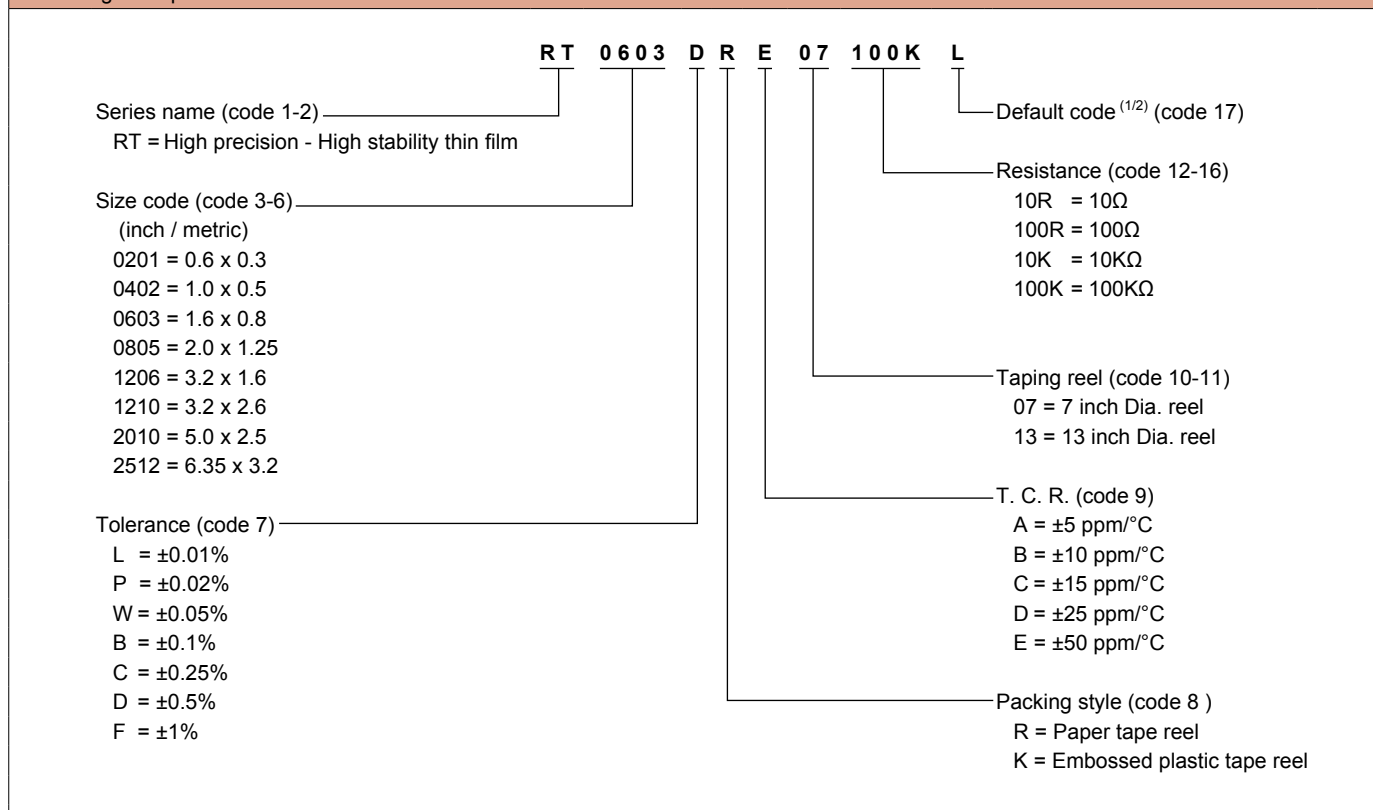

Note: 1. All of our RSMD products are RoHS compliant. "LFP" of the internal 2D reel label mentions "Lead Free Process"
2. Letter L is system default code for ordering only





Chip Resistors Selection Charts

RT - Thin film high precision high stability chip resistors, 0201 to 2512

Phycomp worldwide - Traditional type										
High precision - High stability										
Size: inch (mm)	0402 (1005)				0603 (1608)					
Power	1/16 W				1/10 W					
Tolerance	±1%	±0.5%	±0.25%	±0.1%	±1%	±0.5%	±0.25%	±0.1%		
Resistance	E24 / E96				E24 / E96					
Packing	paper tape				paper tape					
Quantity	TC25 5 000	---	---	---	---	2390 604 7....L	2390 604 6....L	2390 604 5....L	2390 604 4....L	
	TC50 5 000	---	---	---	---	2390 404 7....L	2390 404 6....L	2390 404 5....L	2390 404 4....L	
	TC25 10 000	2390 607 7....L	2390 607 6....L	2390 607 5....L	2390 607 4....L	---	---	---	---	
	TC50 10 000	2390 407 7....L	2390 407 6....L	2390 407 5....L	2390 407 4....L	---	---	---	---	

For ordering rules: See page 14 for E24 / E96 values and the last 4 or 3 digits of the 12NC catalogue number

Phycomp worldwide - Traditional type													
High precision - High stability													
Size: inch (mm)	0805 (2012)				1206 (3216)				1210 (3225)				
Power	1/8 W				1/4 W				1/2 W				
Tolerance	±1%	±0.5%	±0.25%	±0.1%	±1%	±0.5%	±0.25%	±0.1%	±1%	±0.5%	±0.25%	±0.1%	
Resistance	E24 / E96				E24 / E96				E24 / E96				
Packing	paper tape				paper tape				paper tape				
Quantity	TC10 5 000	2390 801 7....L	2390 801 6....L	2390 801 5....L	2390 801 4....L	2390 811 7....L	2390 811 6....L	2390 811 5....L	2390 811 4....L	2390 812 7....L	2390 812 6....L	2390 812 5....L	2390 812 4....L
	TC15 5 000	2390 701 7....L	2390 701 6....L	2390 701 5....L	2390 701 4....L	2390 711 7....L	2390 711 6....L	2390 711 5....L	2390 711 4....L	2390 712 7....L	2390 712 6....L	2390 712 5....L	2390 712 4....L
	TC25 5 000	2390 601 7....L	2390 601 6....L	2390 601 5....L	2390 601 4....L	2390 611 7....L	2390 611 6....L	2390 611 5....L	2390 611 4....L	2390 612 7....L	2390 612 6....L	2390 612 5....L	2390 612 4....L
	TC50 5 000	2390 401 7....L	2390 401 6....L	2390 401 5....L	2390 401 4....L	2390 411 7....L	2390 411 6....L	2390 411 5....L	2390 411 4....L	2390 412 7....L	2390 412 6....L	2390 412 5....L	2390 412 4....L

For ordering rules: See page 14 for E24 / E96 values and the last 4 or 3 digits of the 12NC catalogue number

Phycomp worldwide - Traditional type										
High precision - High stability										
Size: inch (mm)	2010 (5025)				2512 (6432)					
Power	1/2 W				3/4 W					
Tolerance	±1%	±0.5%	±0.25%	±0.1%	±1%	±0.5%	±0.25%	±0.1%		
Resistance	E24 / E96				E24 / E96					
Packing	blister tape				blister tape					
Quantity	TC10 4 000	2390 815 7....L	2390 815 6....L	2390 815 5....L	2390 815 4....L	2390 818 7....L	2390 818 6....L	2390 818 5....L	2390 818 4....L	
	TC15 4 000	2390 731 7....L	2390 731 6....L	2390 731 5....L	2390 731 4....L	2390 735 7....L	2390 735 6....L	2390 735 5....L	2390 735 4....L	
	TC25 4 000	2390 615 7....L	2390 615 6....L	2390 615 5....L	2390 615 4....L	2390 618 7....L	2390 618 6....L	2390 618 5....L	2390 618 4....L	
	TC50 4 000	2390 415 7....L	2390 415 6....L	2390 415 5....L	2390 415 4....L	2390 418 7....L	2390 418 6....L	2390 418 5....L	2390 418 4....L	

For ordering rules: See page 14 for E24 / E96 values and the last 4 or 3 digits of the 12NC catalogue number

Thin film product range against tolerance / T. C. R. (ordering code)																		
Tolerance	±0.05% (W)				±0.1% (B)				±0.25% (C)				±0.5% (D)		±1% (F)			
T. C. R. (ppm/°C)	±5 (A)	±10 (B)	±15 (C)	±25 (D)	±50 (E)	±5 (A)	±10 (B)	±15 (C)	±25 (D)	±50 (E)	±5 (A)	±10 (B)	±15 (C)	±25 (D)	±50 (E)	±25 (D)	±50 (E)	
RT0201									22R - 75K	22R - 75K				22R - 75K	22R - 75K	22R - 75K	22R - 75K	
RT0402	20R-10K	20R-12K	20R-12K	20R-12K	20R-12K	20R-10K	20R-70K	20R-70K	4.7R-240K	4.7R-240K	20R-10K	20R-70K	20R-70K	4.7R-240K	4.7R-240K	4.7R-240K	4.7R-240K	4.7R-240K
RT0603	20-30K	4.7R-100K	4.7R-100K	4.7R-100K	4.7R-100K	20-30K	4.7R-332K	4.7R-332K	1R-1M	1R-1M	20-30K	4.7R-332K	4.7R-332K	1R-1M	1R-1M	1R-1M	1R-1M	1R-1M
RT0805	20-50K	4.7R-200K	4.7R-200K	4.7R-200K	4.7R-200K	20-50K	4.7R-800K	4.7R-800K	1R-1.5M	1R-1.5M	20-50K	4.7R-800K	4.7R-800K	1R-1.5M	1R-1.5M	1R-1.5M	1R-1.5M	1R-1.5M
RT1206	20-100K	5.6R-500K	5.6R-500K	5.6R-500K	5.6R-500K	20-100K	5.6R-1M	5.6R-1M	1R-1.5M	1R-1.5M	20-100K	5.6R-1M	5.6R-1M	1R-1.5M	1R-1.5M	1R-1.5M	1R-1.5M	1R-1.5M
RT1210		100R-100K	100R-100K	4.7R-1M	4.7R-1M		4.7R-100K	4.7R-100K	4.7R-1M	4.7R-1M		4.7R-100K	4.7R-100K	4.7R-1M	4.7R-1M	4.7R-1M	4.7R-1M	4.7R-1M
RT2010		100R-100K	100R-100K	4.7R-1M	4.7R-1M		4.7R-100K	4.7R-100K	4.7R-1M	4.7R-1M		4.7R-100K	4.7R-100K	4.7R-1M	4.7R-1M	4.7R-1M	4.7R-1M	4.7R-1M
RT2512		100R-100K	100R-100K	4.7R-1M	4.7R-1M		4.7R-100K	4.7R-100K	4.7R-1M	4.7R-1M		4.7R-100K	4.7R-100K	4.7R-1M	4.7R-1M	4.7R-1M	4.7R-1M	4.7R-1M



Chip Resistors Selection Charts

AT - Automotive grade thin film high precision high stability chip resistors, 0402 to 1206



Features

- High precision - High stability
- Low T. C. R. / low noise
- High accuracy ($\pm 0.1\%$, $\pm 0.25\%$, $\pm 0.5\%$, $\pm 1\%$)
- Superior resistance against sulfur containing atmosphere
- AEC-Q200 qualified

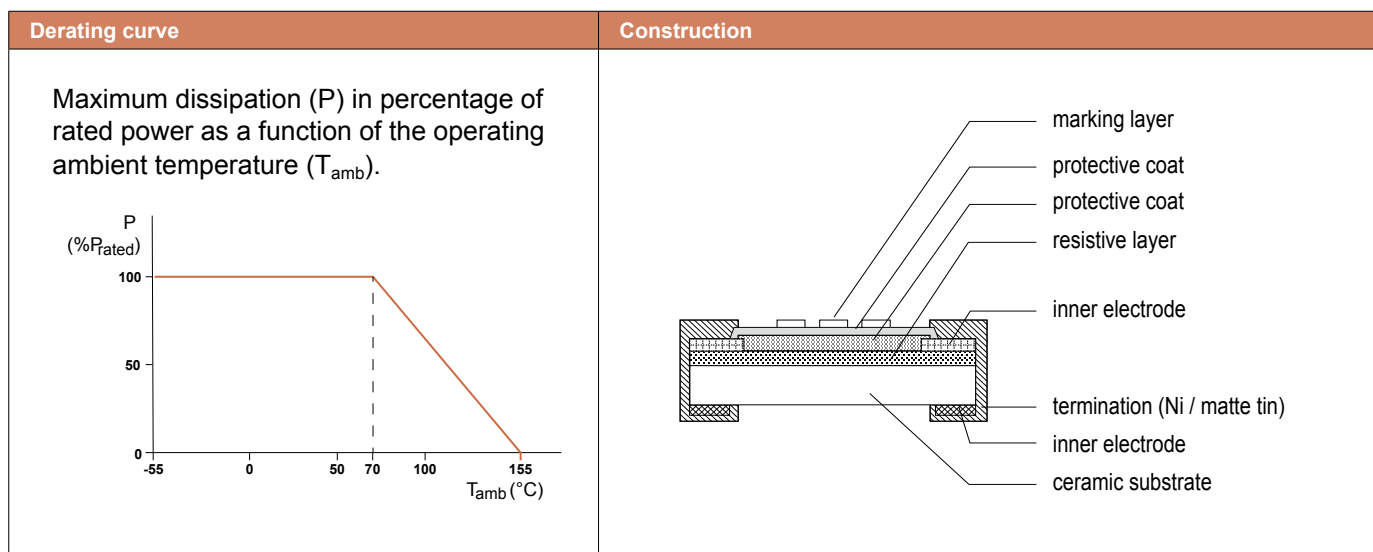

Dimensions						
<p>unit: mm</p>	Type	L	W	H	l_1	l_2
	AT0402	1.00 ± 0.10	0.50 ± 0.05	0.30 ± 0.05	0.20 ± 0.10	0.25 ± 0.10
	AT0603	1.60 ± 0.10	0.80 ± 0.10	0.45 ± 0.10	0.25 ± 0.15	0.25 ± 0.15
	AT0805	2.00 ± 0.10	1.25 ± 0.10	0.50 ± 0.10	0.35 ± 0.20	0.35 ± 0.20
	AT1206	3.10 ± 0.10	1.60 ± 0.10	0.55 ± 0.10	0.45 ± 0.20	0.40 ± 0.20

Electrical characteristics										
Type	Power rating	Operating Temp. range	MWV	RCOV	DWV	Resistance Range (E24/E96) & tolerance				T. C. R. (ppm/°C)
						$\pm 0.1\%$	$\pm 0.25\%$	$\pm 0.5\%$	$\pm 1.0\%$	
AT0402	1/16W	-55°C to +155°C	50V	100V	100V	10Ω~11KΩ				± 15 ppm/°C
						10Ω~100KΩ				± 25 ppm/°C, ± 50 ppm/°C
AT0603	1/10W		75V	150V	100V	10Ω~14KΩ				± 15 ppm/°C
						10Ω~330KΩ				± 25 ppm/°C, ± 50 ppm/°C
AT0805	1/8W		150V	300V	300V	10Ω~17KΩ				± 15 ppm/°C
		10Ω~1MΩ				± 25 ppm/°C, ± 50 ppm/°C				
AT1206	1/4W	200V	400V	500V	10Ω~20KΩ				± 15 ppm/°C	
					10Ω~1MΩ				± 25 ppm/°C, ± 50 ppm/°C	



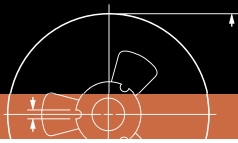

Chip Resistors Selection Charts

AT - Automotive grade thin film high precision high stability chip resistors, 0402 to 1206

Environmental characteristics				
Performance test	Test method	Procedure	Requirements	
Life/ Endurance	AEC-Q200 Test 8 MIL-STD-202 Method 108	1000 hours at 70± 5°C, RCWV applied for 1.5 hours on, 0.5 hour off, still air required	± (0.1%+50mΩ)	
		1000 hours at 125°C, derated voltage applied for 1.5 hours on, 0.5 hour off, still air required	± (0.3%+50mΩ)	
High Temperature Exposure temperature	AEC-Q200 Test 3 MIL-STD-202 Method 108	1000 hours at Tamb = 125°C, unpowered	± (0.1%+50mΩ)	
		1000 hours at Tamb = 155°C, unpowered	± (0.3%+50mΩ)	
Moisture Resistance	AEC-Q200 Test 6 MIL-STD-202 Method 106	Each temperature / humidity cycle is defined at 8 hours (method 106F), 3 cycles / 24 hours for 10d. with 25°C / 65°C 95% R.H, without steps 7a & 7b, unpowered Parts mounted on test-boards, without condensation on parts	± (0.1%+50mΩ)	
Thermal Shock	AEC-Q200 Test 16 MIL-STD-202 Method 107	-55 / +125°C Number of cycles is 300. Devices mounted Maximum transfer time is 20 seconds. Dwell time is 15 minutes. Air -Air	± (0.1%+50mΩ) No visible damage	
Short time overload	IEC60115-1 4.13	2.5 times of rated voltage or maximum overload voltage, the less of the above, for 5 sec at room temperature	± (0.05%+50mΩ)	
Solderability	Wetting	AEC-Q200 Test 18 J-STD-002	Electrical Test not required Magnification 50X SMD conditions: (a) Method B, aging 4 hours at 155°C dry heat, dipping at 235± 3°C for 5± 0.5 seconds. (b) Method B, steam aging 8 hours, dipping at 215± 3°C for 5± 0.5 seconds. (c) Method D, steam aging 8 hours, dipping at 260± 3°C for 7± 0.5 seconds	Well tinned (>95% covered) No visible damage
	Resistance to soldering heat	AEC-Q200 Test 15 MIL-STD-202 Method 210	Condition B, no pre-heat of samples Lead-free solder, 260± 5°C, 10± 1 seconds immersion time Procedure 2 for SMD: devices fluxed and cleaned with isopropanol	± (0.05%+50mΩ)
FOS	ASTM-B-809-5* * Modified	Sulfur 750 hours, 105°C, Rating with no power	± (4%+50mΩ)	

Global part number - Preferred type for ordering Yageo / Phycomp branded products

Ordering example: AT0603DRE07100KL

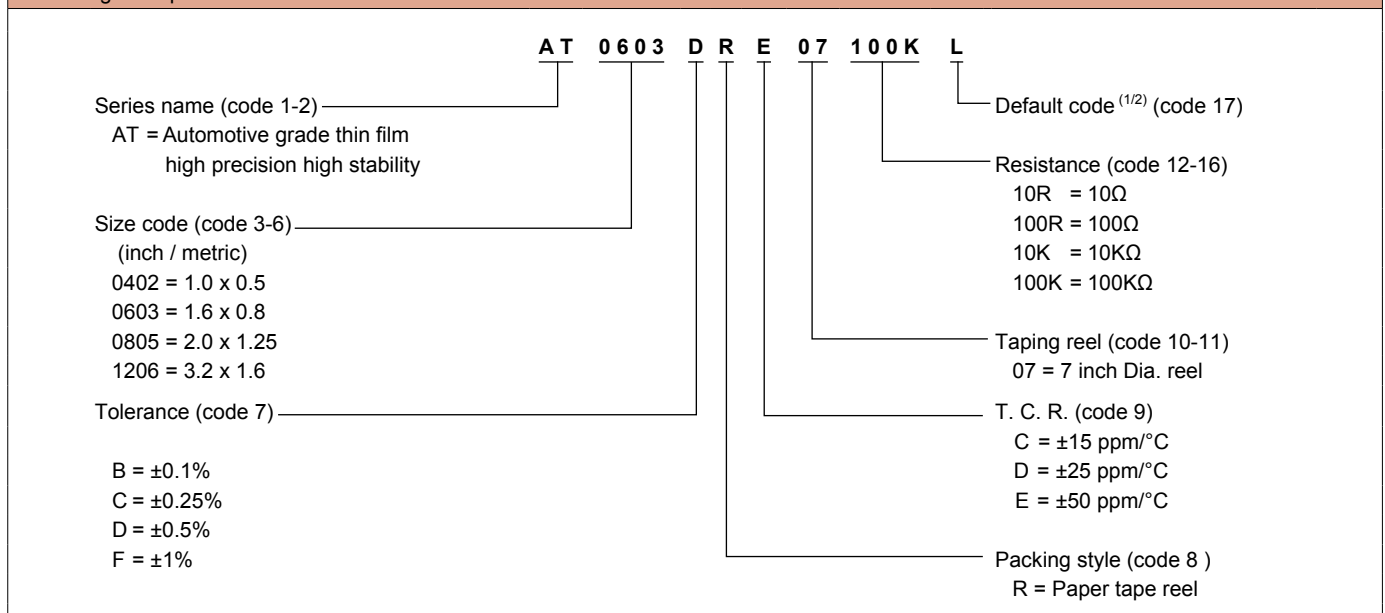

Note: 1. All of our RSMD products are RoHS compliant. "LFP" of the internal 2D reel label mentions "Lead Free Process"
2. Letter L is system default code for ordering only



Chip Resistors Selection Charts

RL - Thick film low ohmic chip resistors, 0402 to 2512



Features

- Current sensing of desktop & notebook PC
- Resistance values down to 0.01Ω
- Highly reliable electrode construction

Derating curve

Maximum dissipation (P) in percentage of rated power as a function of the operating ambient temperature (T_{amb}).

Normal Power: Range: -55°C to $+155^{\circ}\text{C}$

Double Power: Range: -55°C to $+125^{\circ}\text{C}$

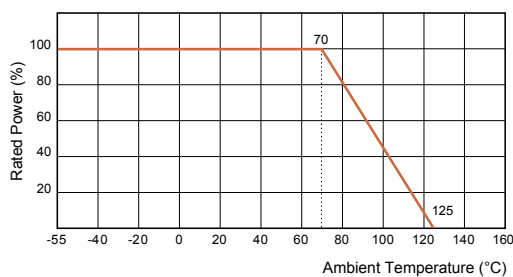
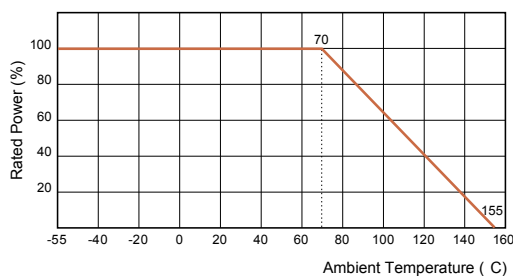

Construction

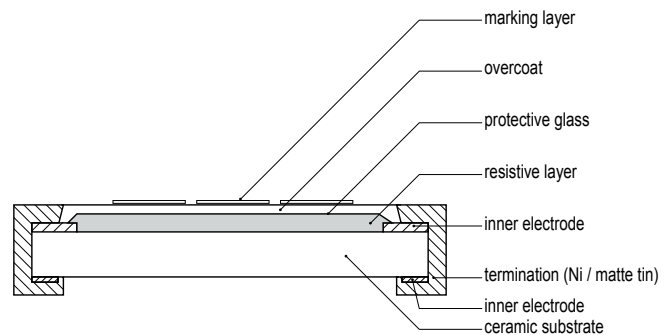

Dimensions

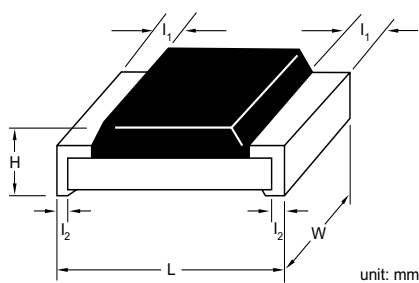

Type	L	W	H	l_1	l_2
RL0402	1.00 ± 0.10	0.50 ± 0.05	0.35 ± 0.05	0.20 ± 0.10	0.25 ± 0.10
RL0603	1.60 ± 0.10	0.80 ± 0.10	0.45 ± 0.10	0.25 ± 0.15	0.25 ± 0.15
RL0805	2.00 ± 0.10	1.25 ± 0.10	0.50 ± 0.10	0.35 ± 0.20	0.35 ± 0.20
RL1206	3.10 ± 0.10	1.60 ± 0.10	0.55 ± 0.10	0.45 ± 0.20	0.45 ± 0.20
RL1210	3.10 ± 0.10	2.60 ± 0.15	0.55 ± 0.10	0.50 ± 0.20	0.50 ± 0.20
RL1218	3.05 ± 0.15	4.60 ± 0.20	0.55 ± 0.10	0.45 ± 0.25	0.50 ± 0.25
RL2010	5.00 ± 0.10	2.50 ± 0.15	0.55 ± 0.10	0.60 ± 0.20	0.50 ± 0.20
RL2512	6.35 ± 0.10	3.20 ± 0.15	0.55 ± 0.10	0.60 ± 0.20	0.50 ± 0.20



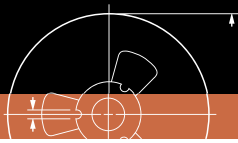

Chip Resistors Selection Charts

RL - Thick film low ohmic chip resistors, 0402 to 2512

Electrical characteristics						
Type	Power P ₇₀	Operating Temp. range	Resistance range & tolerance		T. C. R.	Jumper criteria
RL0402	1/16W	-55°C to +155°C	E24 ±1%, ±2%, ±5%	50mΩ ≤ R < 1Ω	See following table "T.C.R.- RL series"	Max. resistance 20mΩ Rated current 1.5A
RL0603	1/10W			10mΩ ≤ R < 1Ω		Max. resistance 20mΩ Rated current 2A
RL0805	1/8W	10mΩ ≤ R < 1Ω		Max. resistance 20mΩ Rated current 2.5A		
	1/4W	-55°C to +125°C		10mΩ ≤ R < 1Ω		-- --
RL1206	1/4W	-55°C to +155°C		10mΩ ≤ R < 1Ω		Max. resistance 20mΩ Rated current 3.5A
	1/2W	-55°C to +125°C		10mΩ ≤ R < 1Ω		-- --
RL1210	1/2W	-55°C to +155°C		10mΩ ≤ R < 1Ω		-- --
RL1218	1W			10mΩ ≤ R < 1Ω		-- --
RL2010	3/4W			10mΩ ≤ R < 1Ω		-- --
RL2512	1W			10mΩ ≤ R < 1Ω		-- --
			10mΩ ≤ R < 1Ω	-- --		

Note: The partial values of 25 / 40 / 50 / 60 / 250 / 400 / 500 mΩ are also available

T. C. R. - RL series										
Type	Operating Temp. range	Resistance range	T. C. R.							
			50mΩ ≤ R < 100mΩ	100mΩ ≤ R < 500mΩ		500mΩ ≤ R < 1Ω				
RL0402	-55°C to +125°C	50mΩ ≤ R < 1Ω	±1000 ppm/°C		±800 ppm/°C		±300 ppm/°C			
RL0603	-55°C to +125°C	10mΩ ≤ R < 1Ω	10mΩ ≤ R ≤ 36mΩ	36mΩ ≤ R ≤ 91mΩ	91mΩ < R ≤ 500mΩ	500mΩ < R < 1Ω				
			±1500 ppm/°C		±1200 ppm/°C		±800 ppm/°C	±300 ppm/°C		
RL0805	-55°C to +125°C	10mΩ ≤ R < 1Ω	10mΩ ≤ R ≤ 18mΩ	18mΩ < R ≤ 47mΩ	47mΩ < R ≤ 91mΩ	91mΩ < R ≤ 360mΩ	360mΩ < R ≤ 500mΩ	500mΩ < R < 1Ω		
			±1500 ppm/°C		±1200 ppm/°C		±1000 ppm/°C	±600 ppm/°C	±300 ppm/°C	±200 ppm/°C
			±1500 ppm/°C		±1000 ppm/°C		±800 ppm/°C	±600 ppm/°C	±300 ppm/°C	±200 ppm/°C
RL1206	-55°C to +125°C	10mΩ ≤ R < 1Ω	10mΩ ≤ R ≤ 30mΩ		30mΩ < R ≤ 56mΩ		56mΩ < R ≤ 180mΩ		180mΩ < R < 1Ω	
			±2000 ppm/°C		±1000 ppm/°C		±700 ppm/°C		±250 ppm/°C	
RL1210	-55°C to +125°C	10mΩ ≤ R < 1Ω	10mΩ ≤ R ≤ 18mΩ	18mΩ < R ≤ 47mΩ	47mΩ < R ≤ 91mΩ	91mΩ < R ≤ 360mΩ	360mΩ < R ≤ 500mΩ	500mΩ < R < 1Ω		
			±1500 ppm/°C		±1200 ppm/°C		±1000 ppm/°C	±600 ppm/°C	±300 ppm/°C	±200 ppm/°C
RL2010	-55°C to +125°C	10mΩ ≤ R < 1Ω	±1500 ppm/°C		±1200 ppm/°C		±1000 ppm/°C	±600 ppm/°C	±300 ppm/°C	±200 ppm/°C
RL2512			±1500 ppm/°C		±1200 ppm/°C		±800 ppm/°C	±600 ppm/°C	±300 ppm/°C	±200 ppm/°C

Environmental characteristics			
Performance test	Test method	Procedure	Requirements
Life	MIL-STD-202 Method 108A	1000 hours at 70°C ±2°C applied RCWV 1.5 hours on, 0.5 hours off, still air required	± (2%+0.5mΩ)
High temperature exposure	MIL-STD-202 Method 108A	1000 hours at maximum operating temperature depending on specification, unpowered	± (1%+0.5mΩ)
Moisture resistance	MIL-STD-202 Method 106G	Each temperature / humidity cycle is defined as 8 hours (method 106G), 3 cycles / 24 hours for 10d with 25°C / 65°C 95% R.H	± (2%+0.5mΩ)
Thermal shock	MIL-STD-202 Method 107G	-55 / +125°C Note: Number of cycles required is 300. Devices mounted Maximum transfer time is 20 seconds. Dwell time is 15 minutes. Air – Air	± (1%+0.5mΩ)
Solderability	Wetting	J-STD-002B test B Electrical test not required. Magnification 50X Lead-free solder bath at 245 ±3°C Dipping time: 3 ±0.5 seconds	Well tinned (≥ 95% covered) No visible damage
	Resistance to soldering heat	MIL-STD-202 method 210F Lead-free solder, 260°C, 10 seconds immersion time	± (1%+0.5mΩ) No visible damage
Short time overload	IEC 60115 -1 4.13	RL standard power: 6.25 times of rated power for 5 seconds at room temperature RL high power: 5 times of rated power for 5 seconds at room temperature	± (2%+0.5mΩ) No visible damage



Chip Resistors Selection Charts

RL - Thick film low ohmic chip resistors, 0402 to 2512

Global part number - Preferred type	
Ordering example: RL0603JR-070R01L	
<p>Series name (code 1-2) —————</p> <p>RL = Thick Film Low ohmic</p> <p>Size code (code 3-6) —————</p> <p>(inch / metric)</p> <p>0402 = 1.0 x 0.5</p> <p>0603 = 1.6 x 0.8</p> <p>0805 = 2.0 x 1.25</p> <p>1206 = 3.2 x 1.6</p> <p>1210 = 3.2 x 2.6</p> <p>1218 = 3.2 x 4.5</p> <p>2010 = 5.0 x 2.5</p> <p>2512 = 6.35 x 3.2</p> <p>Tolerance (code 7) —————</p> <p>F = ±1%</p> <p>G = ±2%</p> <p>J = ±5%</p> <p>"-" = Jumper ordering</p>	<p style="text-align: center;">RL 0603 J R - 07 0R01 L</p> <p>————— Default code^(1/2) (code 17)</p> <p>————— Resistance (code 12-16)</p> <p>0R01 = 0.01Ω</p> <p>0R1 = 0.1Ω</p> <p>0R2 = 0.2Ω</p> <p>————— Taping reel (code 10-11)</p> <p>07 = 7 inch Dia. reel</p> <p>13 = 13 inch Dia. reel</p> <p>————— T. C. R. (code 9)</p> <p>"—" = Based on spec.</p> <p>(— for thick film only)</p> <p>————— Packing style (code 8)</p> <p>R = Paper tape reel</p> <p>K = Embossed plastic tape reel</p>

Note: 1. All of our RSMD products are RoHS compliant. "LFP" of the internal 2D reel label mentions "Lead Free Process"
 2. Letter L is system default code for ordering only

Phycomp worldwide - Traditional type								
Low ohmic chip resistors								
Size: inch (mm)	0402 (1005)		0603 (1608)		0805 (2012)		1206 (3216)	
Power	1/16 W		1/10 W		1/8 W		1/4 W	
Tolerance	+5%	+1%	+5%	+1%	+5%	+1%	+5%	+1%
Resistance	E24	E24	E24	E24	E24	E24	E24	E24
Packing	paper tape		paper tape		paper tape		paper tape	
Quantity	5 000	---	2350 512 10...L	2350 512 12...L	2350 511 10...L	2350 511 12...L	2350 510 10...L	2350 510 12...L
	10 000	2350 513 20...L	2350 513 22...L	---	---	---	---	---

For ordering rules: See page 14 for E24 / E96 values and the last 4 or 3 digits of the 12NC catalogue number

Phycomp worldwide - Traditional type								
Low ohmic chip resistors								
Size: inch (mm)	1210 (3225)		1218 (3248)		2010 (5025)		2512 (6432)	
Power	1/2 W		1 W		3/4 W		1 W	
Tolerance	+5%	+1%	+5%	+1%	+5%	+1%	+5%	+1%
Resistance	E24	E24	E24	E24	E24	E24	E24	E24
Packing	paper tape		blister tape		blister tape		blister tape	
Quantity	4 000	---	2322 735 64...L	2322 735 7...L	2322 760 90..0L/60..7L	2322 761 90..0L/6...7L	2322 762 90..0L/60..7L	2322 763 90..0L/6...7L
	5 000	2390 735 90..0L/60..7L	2390 735 3...L	---	---	---	---	---

For ordering rules: See page 14 for E24 / E96 values and the last 4 or 3 digits of the 12NC catalogue number

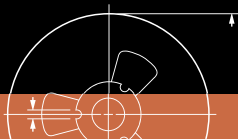

Chip Resistors Selection Charts

RL - Thick film low ohmic, high power chip resistors, 0805 / 1206

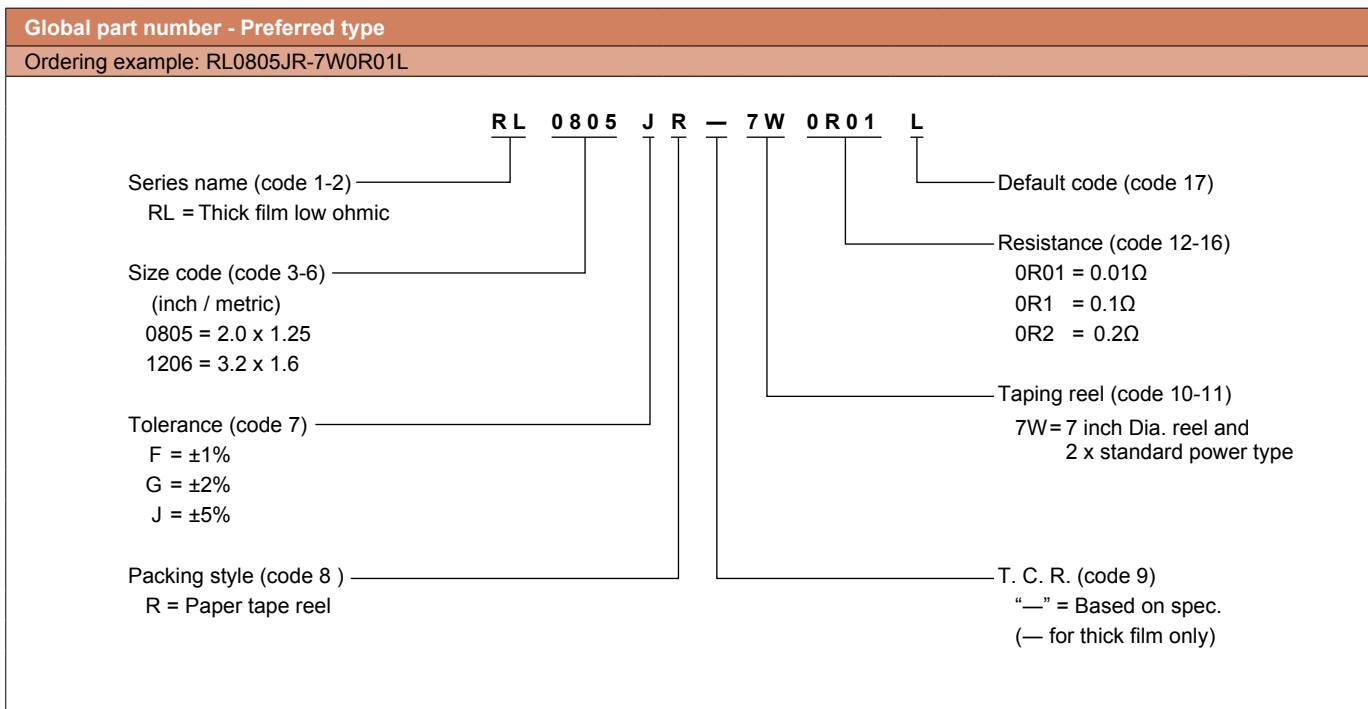

Note: 1. All of our RSMD products are RoHS compliant. "LFP" of the internal 2D reel label mentions "Lead Free Process"
 2. Letter L is system default code for ordering only

Phycomp worldwide - Traditional type

Low ohmic high power chip resistors

Size: inch (mm)	0805 (2012)		1206 (3216)	
Power	1/4 W		1/2 W	
Tolerance	+5%	+1%	+5%	+1%
Resistance	E24	E24 / E96	E24	E24 / E96
Packing	paper tape		paper tape	
Quantity 5000	2350 511 15...L	2350 511 17...L	2350 519 01...L	2350 519 1...L

For ordering rules: See page 14 for E24 / E96 values and the last 4 or 3 digits of the 12NC catalogue number



Chip Resistors Selection Charts

PT - Thick film low ohmic low T. C. R. chip resistors, 0402 to 2512

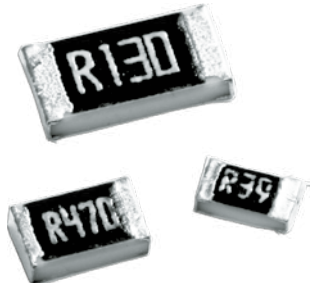

Features

- Excellent T. C. R.
- Precision current sensing control
- Excellent performance for current sensing applications
- Low ohmic and high power

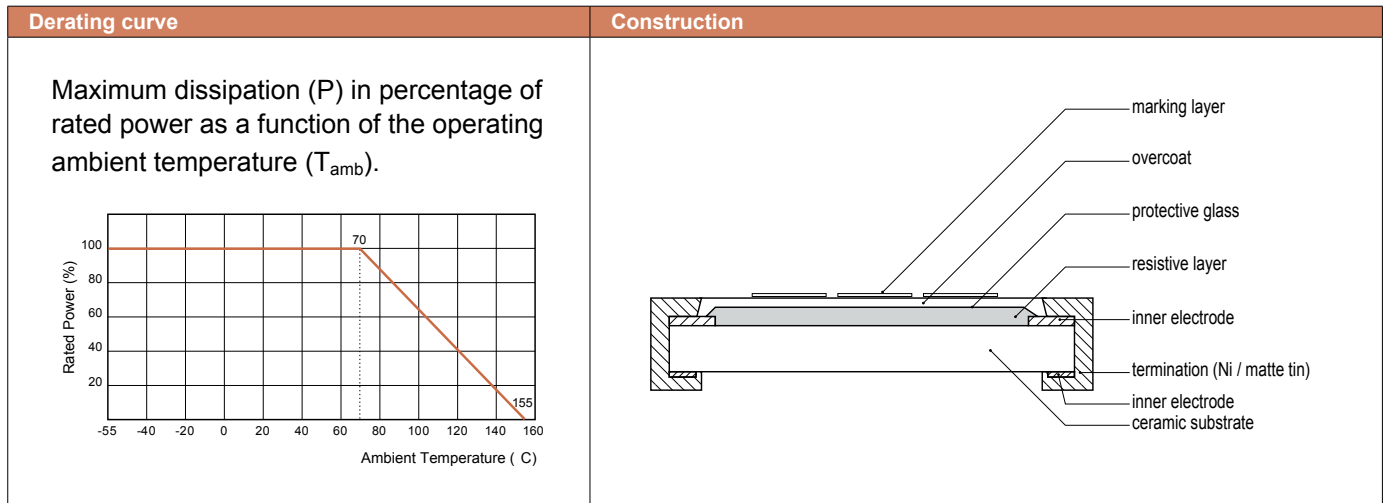

Dimensions																																																	
<p>unit: mm</p>	<table border="1"> <thead> <tr> <th>Type</th> <th>L</th> <th>W</th> <th>H</th> <th>l_1</th> <th>l_2</th> </tr> </thead> <tbody> <tr> <td>PT0402</td> <td>1.00 ± 0.10</td> <td>0.50 ± 0.05</td> <td>0.35 ± 0.05</td> <td>0.20 ± 0.10</td> <td>0.25 ± 0.10</td> </tr> <tr> <td>PT0603</td> <td>1.60 ± 0.10</td> <td>0.80 ± 0.10</td> <td>0.45 ± 0.10</td> <td>0.25 ± 0.15</td> <td>0.25 ± 0.15</td> </tr> <tr> <td>PT0805</td> <td>2.00 ± 0.10</td> <td>1.25 ± 0.10</td> <td>0.55 ± 0.10</td> <td>0.35 ± 0.20</td> <td>0.35 ± 0.20</td> </tr> <tr> <td>PT1206 ($50m\Omega \leq R < 75m\Omega$ & $91m\Omega \leq R < 1\Omega$)</td> <td>$3.10 \pm 0.10$</td> <td>$1.60 \pm 0.10$</td> <td>$0.55 \pm 0.10$</td> <td>$0.45 \pm 0.20$</td> <td>$0.45 \pm 0.20$</td> </tr> <tr> <td>PT1206 ($75m\Omega \leq R < 91m\Omega$)</td> <td>$3.10 \pm 0.10$</td> <td>$1.60 \pm 0.10$</td> <td>$0.55 \pm 0.10$</td> <td>$0.75 \pm 0.20$</td> <td>$0.45 \pm 0.20$</td> </tr> <tr> <td>PT2010</td> <td>5.00 ± 0.10</td> <td>2.50 ± 0.15</td> <td>0.55 ± 0.10</td> <td>0.60 ± 0.20</td> <td>0.50 ± 0.20</td> </tr> <tr> <td>PT2512</td> <td>6.35 ± 0.10</td> <td>3.20 ± 0.15</td> <td>0.55 ± 0.10</td> <td>0.60 ± 0.20</td> <td>0.50 ± 0.20</td> </tr> </tbody> </table> <p>Note: For relevant physical dimensions, please refer to above construction outlines Please contact our sales offices, distributors and representatives in your region before ordering</p>	Type	L	W	H	l_1	l_2	PT0402	1.00 ± 0.10	0.50 ± 0.05	0.35 ± 0.05	0.20 ± 0.10	0.25 ± 0.10	PT0603	1.60 ± 0.10	0.80 ± 0.10	0.45 ± 0.10	0.25 ± 0.15	0.25 ± 0.15	PT0805	2.00 ± 0.10	1.25 ± 0.10	0.55 ± 0.10	0.35 ± 0.20	0.35 ± 0.20	PT1206 ($50m\Omega \leq R < 75m\Omega$ & $91m\Omega \leq R < 1\Omega$)	3.10 ± 0.10	1.60 ± 0.10	0.55 ± 0.10	0.45 ± 0.20	0.45 ± 0.20	PT1206 ($75m\Omega \leq R < 91m\Omega$)	3.10 ± 0.10	1.60 ± 0.10	0.55 ± 0.10	0.75 ± 0.20	0.45 ± 0.20	PT2010	5.00 ± 0.10	2.50 ± 0.15	0.55 ± 0.10	0.60 ± 0.20	0.50 ± 0.20	PT2512	6.35 ± 0.10	3.20 ± 0.15	0.55 ± 0.10	0.60 ± 0.20	0.50 ± 0.20
Type	L	W	H	l_1	l_2																																												
PT0402	1.00 ± 0.10	0.50 ± 0.05	0.35 ± 0.05	0.20 ± 0.10	0.25 ± 0.10																																												
PT0603	1.60 ± 0.10	0.80 ± 0.10	0.45 ± 0.10	0.25 ± 0.15	0.25 ± 0.15																																												
PT0805	2.00 ± 0.10	1.25 ± 0.10	0.55 ± 0.10	0.35 ± 0.20	0.35 ± 0.20																																												
PT1206 ($50m\Omega \leq R < 75m\Omega$ & $91m\Omega \leq R < 1\Omega$)	3.10 ± 0.10	1.60 ± 0.10	0.55 ± 0.10	0.45 ± 0.20	0.45 ± 0.20																																												
PT1206 ($75m\Omega \leq R < 91m\Omega$)	3.10 ± 0.10	1.60 ± 0.10	0.55 ± 0.10	0.75 ± 0.20	0.45 ± 0.20																																												
PT2010	5.00 ± 0.10	2.50 ± 0.15	0.55 ± 0.10	0.60 ± 0.20	0.50 ± 0.20																																												
PT2512	6.35 ± 0.10	3.20 ± 0.15	0.55 ± 0.10	0.60 ± 0.20	0.50 ± 0.20																																												



Chip Resistors Selection Charts

PT - Thick film low ohmic low T. C. R. chip resistors, 0402 to 2512

Electrical characteristics						
Type	Power P ₇₀	Operating Temp. range	Max. working voltage	Tolerance	Resistance range & T. C. R.	Jumper criteria
PT0402	1/16W	-55°C to +155°C	(PxR) ^{1/2}	E24 ±2%, ±5% E24/E96 ±1%	50mΩ ≤ R < 68mΩ ±600 ppm/°C 68mΩ ≤ R < 100mΩ ±300 ppm/°C 100mΩ ≤ R < 1Ω ±200 ppm/°C	Max. resistance 10mΩ Rated current 3A
	1/8W					
PT0603	1/10W				50mΩ < R < 68mΩ 0/+400 ppm/°C 68mΩ ≤ R < 100mΩ 0/+300 ppm/°C 100mΩ ≤ R < 1Ω ±200 ppm/°C	Max. resistance 8mΩ Rated current 5A
	1/5W					
	1/3W					
PT0805	1/8W				50mΩ < R < 68mΩ 0/+350 ppm/°C 68mΩ ≤ R < 100mΩ 0/+250 ppm/°C 100mΩ ≤ R < 1Ω ±100 ppm/°C	Max. resistance 5mΩ Rated current 6A
	1/4W					
PT1206	1/4W				50mΩ ≤ R < 75mΩ ±350 ppm/°C 75mΩ ≤ R ≤ 100mΩ ±100 ppm/°C 100mΩ < R < 1Ω ±75 ppm/°C	Max. resistance 5mΩ Rated current 10A
	1/2W					
PT2010	3/4W				100mΩ ±100 ppm/°C 100mΩ < R < 1Ω ±75 ppm/°C	Max. resistance --- Rated current ---
	1W					
PT2512	1W	Max. resistance --- Rated current ---				
	2W					

Environmental characteristics			
Performance test	Test method	Procedure	Requirements
Life	MIL-STD-202 Method 108A	1000 hours at 70 ±2°C applied RCWV 1.5 hours on, 0.5 hours off, still air required	± (1% +0.5mΩ) < 20mΩ for jumper
High temperature exposure	MIL-STD-202 Method 108A	1000 hours at maximum operating temperature depending on specification, unpowered	± (1% +0.5mΩ) < 20mΩ for jumper
Moisture resistance	MIL-STD-202 Method 106G	Each temperature / humidity cycle is defined as 8 hours (method 106G), 3 cycles / 24 hours for 10d with 25°C / 65°C 95% R.H	± (0.5% +0.5mΩ) < 20mΩ for jumper
Thermal shock	MIL-STD-202 Method 107G	-55 / +125°C Note: Number of cycles required is 300. Devices mounted Maximum transfer time is 20 seconds. Dwell time is 15 minutes. Air – Air	± (1% +0.5mΩ) < 10mΩ for jumper
Solderability	Wetting	J-STD-002B test B Electrical test not required. Magnification 50X Lead-free solder bath at 245 ±3°C Dipping time: 3 ±0.5 seconds	Well tinned (≥ 95% covered) No visible damage
	Resistance to soldering heat	MIL-STD-202 method 210F Lead-free solder, 260°C, 10 seconds immersion time	± (0.5% +0.5mΩ) No visible damage < 10mΩ for jumper
Short time overload	IEC 60115 -1 4.13	PT standard power: 6.25 times of rated power for 5 seconds at room temperature PT high power: 5 times of rated power for 5 seconds at room temperature PT jumper: 2.5 times of rated current for 5 seconds at room temperature	± (1% +0.5mΩ) No visible damage < 10mΩ for jumper



Chip Resistors Selection Charts

PT - Thick film low ohmic low T. C. R. chip resistors, 0402 to 2512

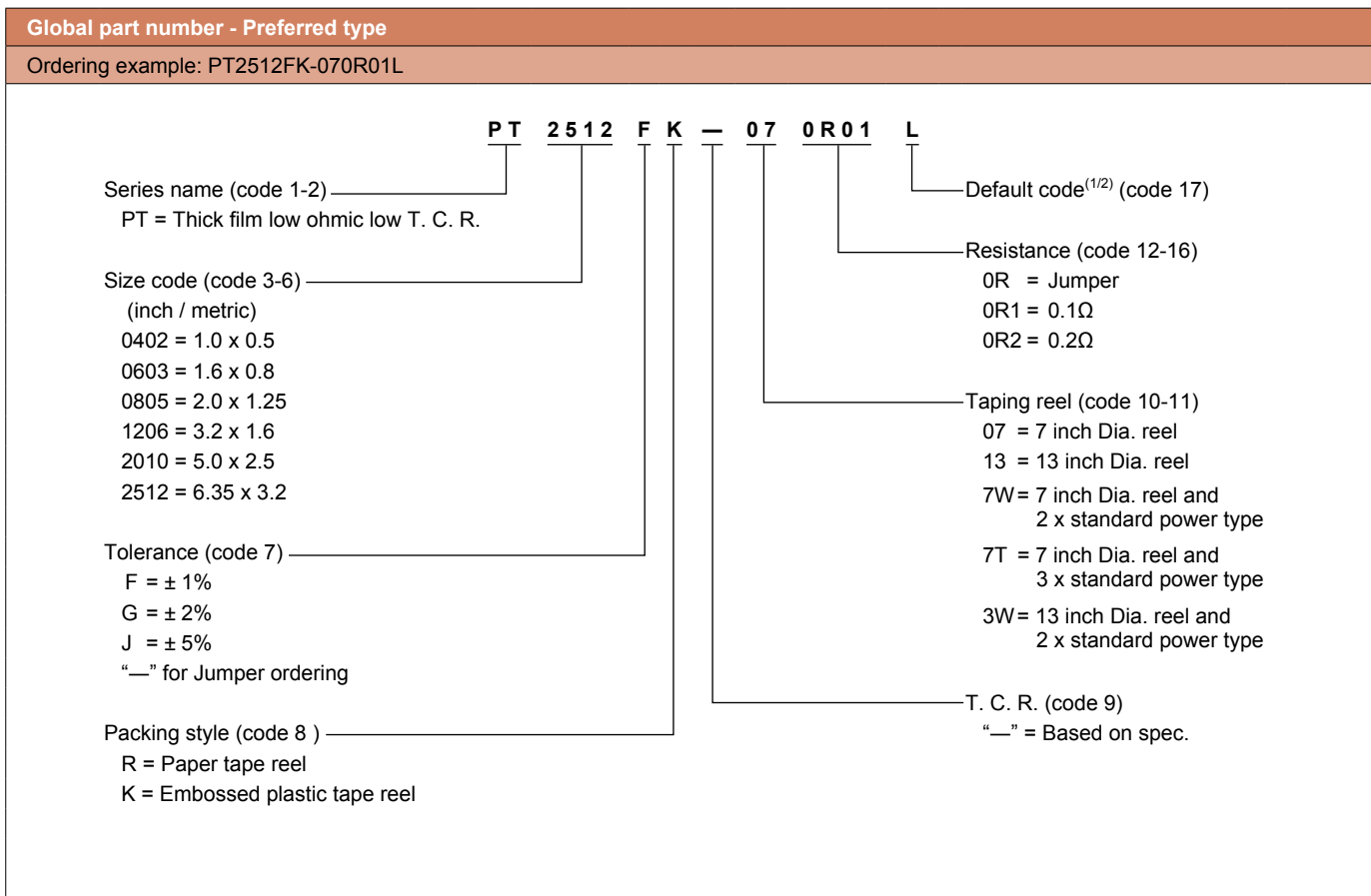

- Note:** 1. All of our RSMD products are RoHS compliant. "LFP" of the internal 2D reel label mentions "Lead Free Process"
 2. Letter L is system default code for ordering only
 3. PT series products are available by "Global part number" only



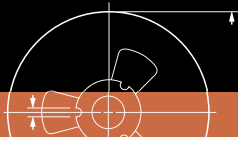

Chip Resistors Selection Charts

PA - Current sensors - low T. C. R. chip resistors, 0201 to 2512

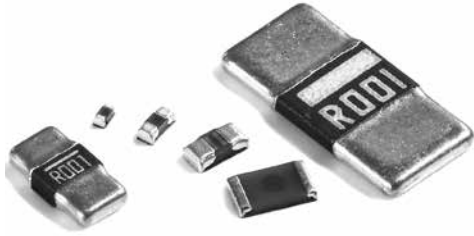

Features

- Excellent T. C. R. compared to thick film low ohmic
- Precision current sensing control
- Excellent performance for current sensing applications
- Ultra low ohmic down to 0.0005Ω

Derating curve	Construction
<p>Maximum dissipation (P) in percentage of rated power as a function of the operating ambient temperature (T_{amb}).</p>	<p>0201~0805</p> <p>1206 / 2512</p> <p>Note: construction will be adjusted to resistance value.</p>

Dimensions						
Type	Resistance range	L	W	H	l_1	l_2
PA0201	$5m\Omega \leq R \leq 10m\Omega$	0.60 ± 0.03	0.31 ± 0.04	Max. 0.3	0.15 ± 0.06	--
PA0402	$5m\Omega \leq R \leq 20m\Omega$	1.00 ± 0.10	0.55 ± 0.10	Max. 0.4	0.25 ± 0.10	--
PA0603	1mΩ	1.60 ± 0.20	0.80 ± 0.20	0.55 ± 0.15	0.38 ± 0.12	--
	$1m\Omega < R \leq 20m\Omega$	1.60 ± 0.20	$0.80 + 0.1/-0.20$	0.45 ± 0.15	0.38 ± 0.12	--
PA0805	1mΩ	2.03 ± 0.20	1.27 ± 0.20	0.45 ± 0.10	0.60 ± 0.15	--
	2mΩ	2.03 ± 0.20	1.27 ± 0.20	0.35 ± 0.10	0.50 ± 0.15	--
	$3m\Omega \leq R \leq 20m\Omega$	2.03 ± 0.20	1.27 ± 0.20	0.30 ± 0.10	0.35 ± 0.10	--
PA1206	1mΩ	3.20 ± 0.25	1.60 ± 0.25	0.65 ± 0.25	1.04 ± 0.25	1.04 ± 0.25
	$2m\Omega \leq R \leq 5m\Omega$	3.20 ± 0.25	1.60 ± 0.25	0.65 ± 0.25	0.64 ± 0.25	0.64 ± 0.25
	$6m\Omega \leq R \leq 50m\Omega$	3.20 ± 0.25	1.60 ± 0.25	0.65 ± 0.25	0.51 ± 0.25	0.51 ± 0.25
PA2512	$0.5m\Omega \leq R \leq 0.75m\Omega$	6.35 ± 0.25	3.18 ± 0.25	0.63 ± 0.25	2.72 ± 0.25	2.72 ± 0.25
	$1m\Omega \leq R \leq 4m\Omega$	6.35 ± 0.25	3.18 ± 0.25	0.63 ± 0.25	2.21 ± 0.25	2.21 ± 0.25
	$5m\Omega \leq R \leq 6m\Omega$	6.35 ± 0.25	3.18 ± 0.25	0.63 ± 0.25	1.19 ± 0.25	1.19 ± 0.25
	$7m\Omega \leq R \leq 100m\Omega$	6.35 ± 0.25	3.18 ± 0.25	0.63 ± 0.25	0.76 ± 0.25	0.76 ± 0.25



Chip Resistors Selection Charts

PA - Current sensors - low T. C. R. chip resistors, 1206 to 2010

Electrical characteristics									
Type	Technology	Size	Power P70	Operating Temp. range	Max. working voltage	Tolerance	Resistance range	T. C. R.	
PA	Metal Plate	0201	1/20W	-55°C to 125°C	(PxR) ^{1/2}	±0.5% ±1% ±5%	5mΩ ≤ R ≤ 10mΩ Jumper < 5mΩ	±150 ppm/°C	
			1/10W						
			3/20W						
			1/5W						
		0402	1/16W				-55°C to 155°C	2.5mΩ 5mΩ ≤ R ≤ 20mΩ Jumper < 1mΩ	±150 ppm/°C
			1/8W						
			1/6W						
			1/4W						
			1/3W						
		0603	1/10W				-55°C to 170°C	1mΩ ≤ R ≤ 20mΩ Jumper < 0.2mΩ	1mΩ ±200 ppm/°C 2mΩ/ 2.5mΩ ±150 ppm/°C 3mΩ~20mΩ ±50 ppm/°C ±75 ppm/°C
			1/5W						
			1/3W						
			2/5W						
			1/2W						
		0805	1/8W	1mΩ ≤ R ≤ 20mΩ Jumper < 0.2mΩ	1mΩ/ 1.5mΩ ±150 ppm/°C 2mΩ~20mΩ ± 50 ppm/°C				
			1/4W						
			1/2W						
			1W						
		1206	1/4W	-55°C to 170°C	1mΩ ≤ R ≤ 50mΩ Jumper < 0.2mΩ	1mΩ ≤ R ≤ 2mΩ ±75 ppm/°C ±100 ppm/°C			
			1/2W						
			1W		3mΩ ≤ R ≤ 50mΩ ±75 ppm/°C ±100 ppm/°C				
			1.5W						
		2512	1W	0.5mΩ ≤ R ≤ 100mΩ	±50 ppm/°C ±75 ppm/°C ±100 ppm/°C				
			2W						
3W									

Note: Please contact with sales offices, distributors and representatives in your region before ordering

Environmental characteristics			
Performance test	Test method	Procedure	Requirements
Life	MIL-STD-202 Method 108A	1000 hours at 70 ±2°C applied RCWV 1.5 hours on, 0.5 hours off, still air required	± (1% +0.5mΩ)
High temperature exposure	MIL-STD-202 Method 108A	1000 hours at maximum operating temperature depending on specification, unpowered	± (1% +0.5mΩ)
Moisture resistance	MIL-STD-202 Method 106G	Each temperature / humidity cycle is defined as 8 hours (method 106G), 3 cycles / 24 hours for 10d with 25°C / 65°C 95% R.H	± (0.5% +0.5mΩ)
Thermal shock	MIL-STD-202 Method 107G	-55 / +125°C Note: Number of cycles required is 300. Devices mounted Maximum transfer time is 20 seconds. Dwell time is 15 minutes. Air – Air	± (0.5% +0.5mΩ)
Solderability	Wetting	J-STD-002B test B Electrical test not required. Magnification 50X Lead-free solder bath at 245 ±3°C Dipping time: 3 ±0.5 seconds	Well tinned (≥ 95% covered)
	Resistance to soldering heat	MIL-STD-202 method 210F Lead-free solder, 260°C, 10 seconds immersion time	± (0.5% +0.5mΩ) No visible damage
Short time overload	IEC 60115 -1 4.13	5 times of rated power for 5 seconds at room temperature	± (0.5% +0.5mΩ) No visible damage



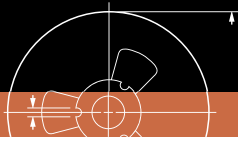

Chip Resistors Selection Charts

PA - Current sensors - low T. C. R. chip resistors, 0201 to 2512

Global part number - Preferred type

Ordering example: PA2512FKF070R01E

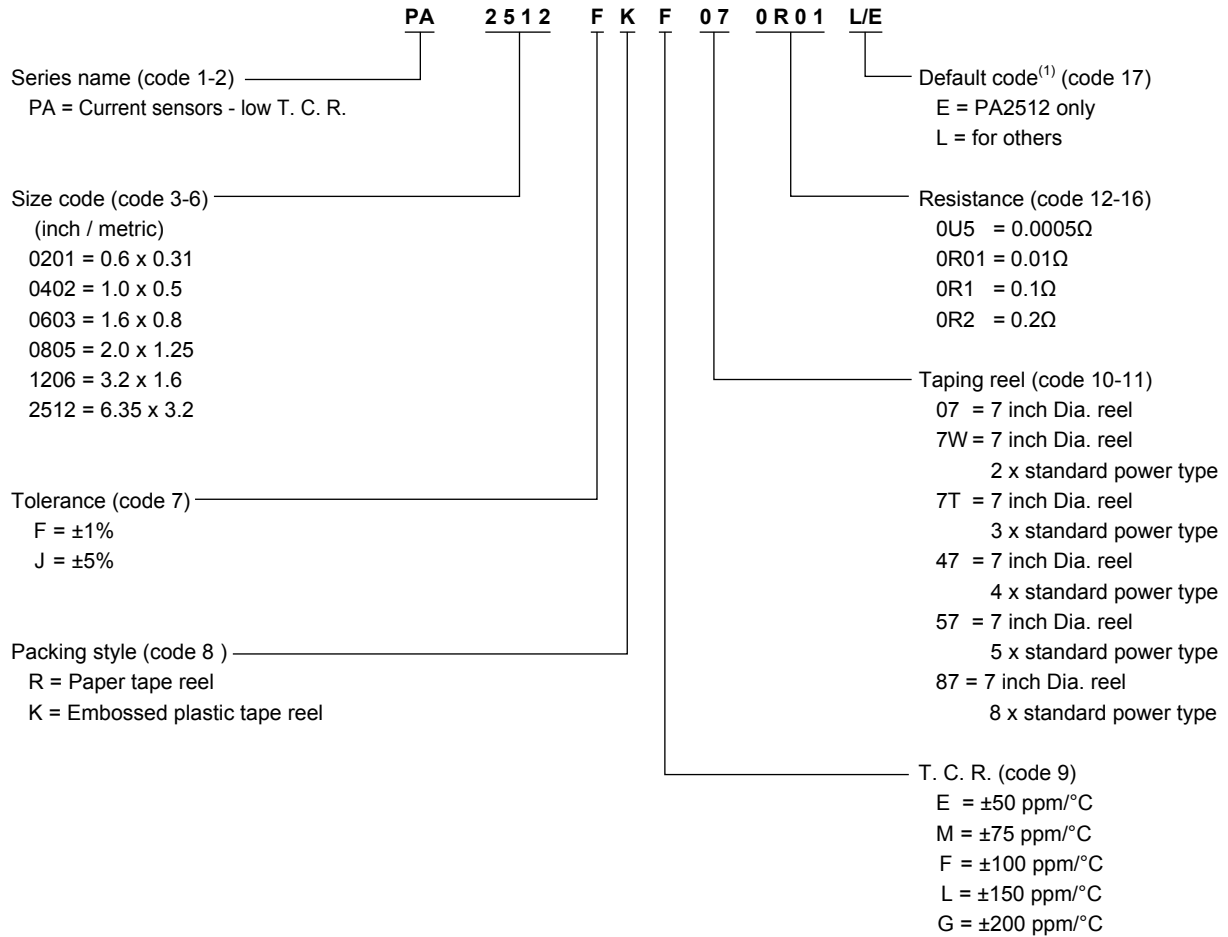

Note: 1. All of our RSMD products are RoHS compliant. "LFP" of the internal 2D reel label mentions "Lead Free Process"



Chip Resistors Selection Charts

PA - Low profile current sensors - low T. C. R. chip resistors, 1206 to 2010

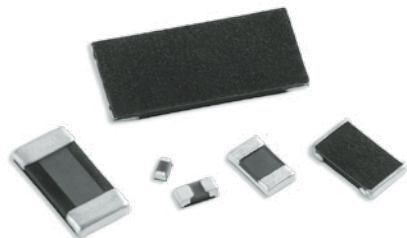

Features

- Excellent T. C. R. compared to thick film low ohmic
- Precision current sensing control
- Excellent performance for current sensing applications
- Ultra low ohmic down to 0.0005Ω

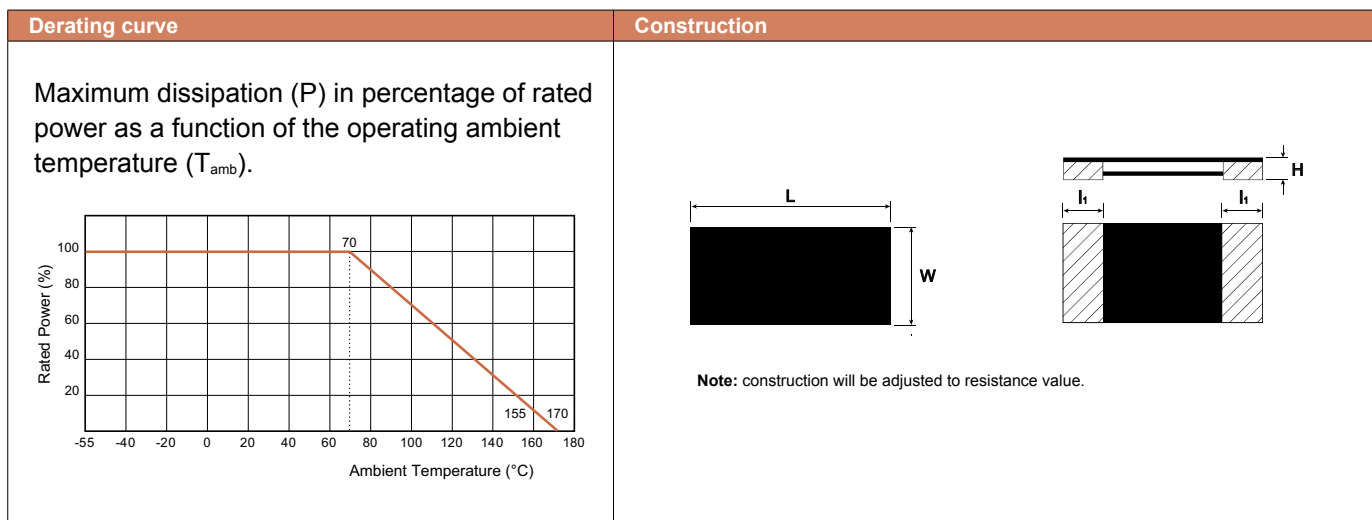

Dimensions					
unit: mm					
Type	Resistance range	L (mm)	W (mm)	H (mm)	l1 (mm)
PA1206	1mΩ	3.20 ± 0.25	1.60 ± 0.25	0.65 ± 0.25	0.51 ± 0.25
	2mΩ	3.20 ± 0.25	1.60 ± 0.25	0.55 ± 0.25	0.60 ± 0.25
	2.5/ 3mΩ	3.20 ± 0.25	1.60 ± 0.25	0.40 ± 0.25	0.80 ± 0.30
	4mΩ ≤ R ≤ 20mΩ	3.20 ± 0.25	1.60 ± 0.25	0.40 ± 0.25	0.60 ± 0.30
PA2010	1mΩ ≤ R ≤ 2mΩ	5.08 ± 0.20	2.54 ± 0.20	0.70 ± 0.15	0.70 ± 0.20
	3mΩ ≤ R ≤ 20mΩ	5.08 ± 0.20	2.54 ± 0.20	0.40 ± 0.15	0.70 ± 0.20

Electrical characteristics								
Type	Technology	Size	Power P70	Operating Temp. range	Max. working voltage	Tolerance	Resistance range	T. C. R.
PA	Metal Plate	1206	1/4W	-55°C to 170°C	(PxR) ^{1/2}	±0.5%	5mΩ ≤ R ≤ 20mΩ	±50 ppm/°C
			1/2W			±1%	1mΩ ≤ R ≤ 20mΩ	
			1W			±5%		
		2010	1/2W			±1%	1mΩ ≤ R ≤ 20mΩ	
			1W					
			2W					
		3W						

Note: Please contact with sales offices, distributors and representatives in your region before ordering.

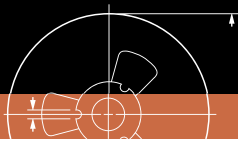

Chip Resistors Selection Charts

PA - Low profile current sensors - low T. C. R. chip resistors, 1206 to 2010

Environmental characteristics				
Performance test		Test method	Procedure	Requirements
Life		MIL-STD-202 Method 108A	1000 hours at 70 ±2°C applied RCWV 1.5 hours on, 0.5 hours off, still air required	± (1% +0.5mΩ)
High temperature exposure		MIL-STD-202 Method 108A	1000 hours at maximum operating temperature depending on specification, unpowered	± (1% +0.5mΩ)
Moisture resistance		MIL-STD-202 Method 106G	Each temperature / humidity cycle is defined as 8 hours (method 106G), 3 cycles / 24 hours for 10d with 25°C / 65°C 95% R.H	± (0.5% +0.5mΩ)
Thermal shock		MIL-STD-202 Method 107G	-55 / +125°C Note: Number of cycles required is 300. Devices mounted Maximum transfer time is 20 seconds. Dwell time is 15 minutes. Air – Air	± (0.5% +0.5mΩ)
Solderability	Wetting	J-STD-002B test B	Electrical test not required. Magnification 50X Lead-free solder bath at 245 ±3°C Dipping time: 3 ±0.5 seconds	Well tinned (≥ 95% covered)
	Resistance to soldering heat	MIL-STD-202 method 210F	Lead-free solder, 260°C, 10 seconds immersion time	± (0.5% +0.5mΩ) No visible damage
Short time overload		IEC 60115 -1 4.13	5 times of rated power for 5 seconds at room temperature	± (0.5% +0.5mΩ) No visible damage

Global part number - Preferred type

Ordering example: PA1206FRE070R01Z

<p>Series name (code 1-2) _____</p> <p>PA = Current sensors - low T. C. R.</p> <p>Size code (code 3-6) _____</p> <p>(inch / metric)</p> <p>1206 = 3.2 x 1.6</p> <p>2010 = 5.0 x 2.5</p> <p>Tolerance (code 7) _____</p> <p>D = ±0.5%</p> <p>F = ±1%</p> <p>J = ±5%</p> <p>Packing style (code 8) _____</p> <p>R = Paper tape reel</p> <p>K = Embossed plastic tape reel</p>	<p>PA 2010 F K E 07 0R01 Z</p>	<p>Default code⁽¹⁾ (code 17)</p> <p>Z = Default code for PA low profile</p> <p>Resistance (code 12-16)</p> <p>0R001 = 0.001Ω</p> <p>0R01 = 0.01Ω</p> <p>Taping reel (code 10-11)</p> <p>07 = 7 inch Dia. reel</p> <p>7W = 7 inch Dia. reel</p> <p>2 x standard power type</p> <p>47 = 7 inch Dia. reel</p> <p>4 x standard power type</p> <p>67 = 7 inch Dia. reel</p> <p>6 x standard power type</p> <p>T. C. R. (code 9)</p> <p>E = ±50 ppm/°C</p>
---	---	---

Note: 1. All of our RSMD products are RoHS compliant. "LFP" of the internal 2D reel label mentions "Lead Free Process"



Chip Resistors Selection Charts

PE - Current sensors - low T. C. R. chip resistors, 01005 to 2512



Features

- Excellent T. C. R. compared to thick film low ohmic
- Precision current sensing control
- Excellent performance for current sensing applications
- Ultra low ohmic down to 0.0005Ω

Derating curve	Construction
<p>Maximum dissipation (P) in percentage of rated power as a function of the operating ambient temperature (T_{amb}).</p>	<p style="text-align: right;"> marking layer protective coat end termination inner electrode protective coat ceramic substrate resistive layer </p> <p>Note: construction will be adjusted to resistance value.</p>

Dimensions					
unit: mm					
Type	Resistance range	L	W	H	l_1
PE0100	$200m\Omega \leq R \leq 500m\Omega$	0.40 ± 0.03	0.20 ± 0.03	0.14 ± 0.03	0.10 ± 0.03
PE0201	$50m\Omega \leq R \leq 200m\Omega$	0.60 ± 0.03	0.31 ± 0.04	0.27 ± 0.04	0.14 ± 0.06
PE0402	$10m\Omega \leq R \leq 910m\Omega$	$1.00+0.10/-0.15$	$0.50+0.10/-0.15$	0.35 ± 0.15	0.25 ± 0.10
PE0603	$20m\Omega \leq R \leq 50m\Omega$	1.60 ± 0.20	0.76 ± 0.25	0.35 ± 0.25	0.38 ± 0.25
	$51m\Omega \leq R \leq 910m\Omega$	1.52 ± 0.25	0.76 ± 0.25	0.45 ± 0.10	0.38 ± 0.25
PE0805	$20 m\Omega \leq R \leq 50m\Omega$	2.03 ± 0.25	1.27 ± 0.25	0.35 ± 0.25	0.38 ± 0.25
	$51m\Omega \leq R \leq 910m\Omega$			0.55 ± 0.10	0.35 ± 0.20
PE1206	$5m\Omega$	3.20 ± 0.25	1.60 ± 0.25	0.64 ± 0.25	0.64 ± 0.25
	$6m\Omega \leq R \leq 910m\Omega$				0.51 ± 0.25
PE2010	$5m\Omega \leq R \leq 6m\Omega$	5.08 ± 0.25	2.54 ± 0.25	0.64 ± 0.25	1.47 ± 0.25
	$7m\Omega \leq R \leq 910m\Omega$				0.51 ± 0.25
PE2512	$6m\Omega \leq R \leq 910m\Omega$	6.35 ± 0.25	3.18 ± 0.25	0.64 ± 0.25	0.76 ± 0.25



Chip Resistors Selection Charts

PE - Current sensors - low T. C. R. chip resistors, 01005 to 2512

Electrical characteristics										
Type	Technology	Size	Power P70	Operating Temp. range	Max. working voltage	Tolerance	Resistance range	T. C. R.		
PE	Metal Film	01005	1/32W	-55°C to 125°C	$(P \times R)^{1/2}$	±1% ±5%	200mΩ ≤ R ≤ 500mΩ	200mΩ ≤ R < 300mΩ ±300 ppm/°C 300mΩ ≤ R ≤ 500mΩ ±200 ppm/°C		
			1/16W							
		0201	1/20W			-55°C to 170°C	±0.5% R > 10mΩ ±1% ±5%	50mΩ ≤ R ≤ 200mΩ	50mΩ ≤ R ≤ 70mΩ ±350 ppm/°C 70mΩ < R ≤ 200mΩ ±100 ppm/°C	
			1/10W							
		0402	1/16W				±100 ppm/°C			
			1/8W							
			1/6W							
			1/4W							
		0603	1/10W				-55°C to 170°C	±0.5% R > 10mΩ ±1% ±5%	5m, 10m, 20mΩ ≤ R ≤ 910mΩ	±75 ppm/°C ±100 ppm/°C
			1/5W							
			1/3W							
			2/5W							
		0805	1/2W	±75 ppm/°C ±100 ppm/°C						
			1/8W							
			1/4W							
			1/3W							
		1206	1/2W	-55°C to 170°C		±0.5% R > 10mΩ ±1% ±5%		5mΩ ≤ R ≤ 910mΩ	5mΩ ≤ R ≤ 19mΩ ±75 ppm/°C ±100 ppm/°C ±50 ppm/°C 20mΩ ≤ R ≤ 910mΩ ±75 ppm/°C ±100 ppm/°C	
			1/4W							
			1W							
		2010	1/2W			±50 ppm/°C ±75 ppm/°C ±100 ppm/°C				
1W										
2512	1W	±50 ppm/°C ±75 ppm/°C ±100 ppm/°C								
	2W									

Note: Please contact with sales offices, distributors and representatives in your region before ordering

Environmental characteristics			
Performance test	Test method	Procedure	Requirements
Life	MIL-STD-202 Method 108A	1000 hours at 70 ±2°C applied RCWV 1.5 hours on, 0.5 hours off, still air required	± (1% +0.5mΩ)
High temperature exposure	MIL-STD-202 Method 108A	1000 hours at maximum operating temperature depending on specification, unpowered	± (1% +0.5mΩ)
Moisture resistance	MIL-STD-202 Method 106G	Each temperature / humidity cycle is defined as 8 hours (method 106G), 3 cycles / 24 hours for 10d with 25°C / 65°C 95% R.H	± (0.5% +0.5mΩ)
Thermal shock	MIL-STD-202 Method 107G	-55 / +125°C Note: Number of cycles required is 300. Devices mounted Maximum transfer time is 20 seconds. Dwell time is 15 minutes. Air – Air	± (0.5% +0.5mΩ)
Solderability	Wetting	J-STD-002B test B Electrical test not required. Magnification 50X Lead-free solder bath at 245 ±3°C Dipping time: 3 ±0.5 seconds	Well tinned (≥ 95% covered)
	Resistance to soldering heat	MIL-STD-202 method 210F Lead-free solder, 260°C, 10 seconds immersion time	± (0.5% +0.5mΩ) No visible damage
Short time overload	IEC 60115 -1 4.13	5 times of rated power for 5 seconds at room temperature	± (0.5% +0.5mΩ) No visible damage



Chip Resistors Selection Charts

PE - Current sensors - low T. C. R. chip resistors, 01005 to 2512

Global part number - Preferred type

Ordering example: PE2512FKF070R01L

<p>PE</p> <p>Series name (code 1-2)</p> <p>PE = Current sensors - low T. C. R.</p> <p>2512</p> <p>Size code (code 3-6)</p> <p>(inch / metric)</p> <p>0100 = 0.4 x 0.2</p> <p>0201 = 0.6 x 0.31</p> <p>0402 = 1.0 x 0.5</p> <p>0603 = 1.6 x 0.8</p> <p>0805 = 2.0 x 1.25</p> <p>1206 = 3.2 x 1.6</p> <p>2010 = 5.0 x 2.5</p> <p>2512 = 6.35 x 3.2</p> <p>F</p> <p>Tolerance (code 7)</p> <p>D = ±0.5%</p> <p>F = ±1%</p> <p>J = ±5%</p> <p>K</p> <p>Packing style (code 8)</p> <p>R = Paper tape reel</p> <p>K = Embossed plastic tape reel</p>	<p>F</p> <p>Tolerance (code 7)</p> <p>D = ±0.5%</p> <p>F = ±1%</p> <p>J = ±5%</p>	<p>07</p> <p>Taping reel (code 10-11)</p> <p>07 = 7 inch Dia. reel</p> <p>7W = 7 inch Dia. reel</p> <p>2 x standard power type</p> <p>7T = 7 inch Dia. reel</p> <p>3 x standard power type</p> <p>47 = 7 inch Dia. reel</p> <p>4 x standard power type</p> <p>57 = 7 inch Dia. reel</p> <p>5 x standard power type</p>	<p>0R01</p> <p>Resistance (code 12-16)</p> <p>0U5 = 0.0005Ω</p> <p>0R01 = 0.01Ω</p> <p>0R1 = 0.1Ω</p> <p>0R2 = 0.2Ω</p>	<p>L</p> <p>Default code⁽¹⁾ (code 17)</p>
--	--	---	--	---

T. C. R. (code 9)

E = ±50 ppm/°C

M = ±75 ppm/°C

F = ±100 ppm/°C

G = ±200 ppm/°C

I = ±300 ppm/°C

J = ±350 ppm/°C

Note: 1. All of our RSMD products are RoHS compliant. "LFP" of the internal 2D reel label mentions "Lead Free Process"

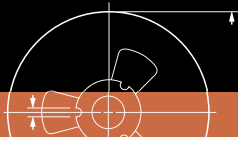

Chip Resistors Selection Charts

PE - Current sensors - low T. C. R. chip resistors, wide termination, 0508 to 0815

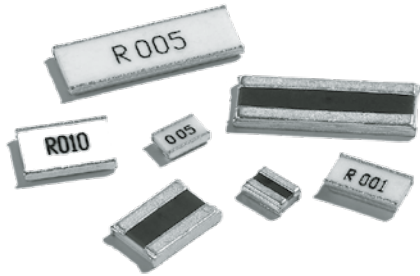

Features

- Excellent T. C. R. compared to thick film low ohmic
- Precision current sensing control
- Excellent performance for current sensing applications
- Low ohmic and high power

Derating curve	Construction																								
<p>Maximum dissipation (P) in percentage of rated power as a function of the operating ambient temperature (T_{amb}).</p> <table border="1"> <caption>Derating Curve Data</caption> <thead> <tr> <th>Ambient Temperature (°C)</th> <th>Rated Power (%)</th> </tr> </thead> <tbody> <tr><td>-55</td><td>100</td></tr> <tr><td>0</td><td>100</td></tr> <tr><td>20</td><td>100</td></tr> <tr><td>40</td><td>100</td></tr> <tr><td>60</td><td>100</td></tr> <tr><td>70</td><td>100</td></tr> <tr><td>80</td><td>90</td></tr> <tr><td>100</td><td>70</td></tr> <tr><td>120</td><td>50</td></tr> <tr><td>140</td><td>30</td></tr> <tr><td>155</td><td>15</td></tr> </tbody> </table>	Ambient Temperature (°C)	Rated Power (%)	-55	100	0	100	20	100	40	100	60	100	70	100	80	90	100	70	120	50	140	30	155	15	<div style="display: flex; justify-content: space-around;"> <div style="text-align: center;"> <p>PE0508</p> </div> <div style="text-align: center;"> <p>PE0612 / 0815</p> </div> </div>
Ambient Temperature (°C)	Rated Power (%)																								
-55	100																								
0	100																								
20	100																								
40	100																								
60	100																								
70	100																								
80	90																								
100	70																								
120	50																								
140	30																								
155	15																								

Dimensions					
unit: mm					
Type	Resistance range	L	W	H	l_1
PE0508	$5m\Omega \leq R \leq 1\Omega$	1.25 ± 0.10	2.00 ± 0.10	0.55 ± 0.15	0.35 ± 0.15
PE0612	$0.5m\Omega / 1m\Omega$	1.60 ± 0.20	3.20 ± 0.20	0.60 ± 0.15	0.55 ± 0.20
	$2m\Omega \leq R \leq 4m\Omega$	1.60 ± 0.20	3.20 ± 0.20	0.60 ± 0.15	0.40 ± 0.20
PE0815	$5m\Omega \leq R \leq 100m\Omega$	1.60 ± 0.20	3.20 ± 0.20	0.60 ± 0.15	0.30 ± 0.15
	$1m\Omega \leq R \leq 2m\Omega$	2.00 ± 0.20	3.70 ± 0.20	0.60 ± 0.15	0.50 ± 0.20
	$3m\Omega \leq R \leq 100m\Omega$	2.00 ± 0.20	3.70 ± 0.20	0.60 ± 0.15	0.60 ± 0.20



Chip Resistors Selection Charts

PE - Current sensors - low T. C. R. chip resistors, wide termination, 0508 to 0815

Electrical characteristics							
Type	Technology	Size	Power P ₇₀	Operating Temp. range	Max. working voltage	Tolerance	Resistance range & T. C. R.
PE	Metal Film	0508	1W	-55°C to +155°C	(P×R) ^{1/2}	±1% ±5%	5mΩ ≤ R < 75mΩ ±100 ppm/°C 75mΩ ≤ R ≤ 1Ω ±50 ppm/°C
		0612	1W				1mΩ ±150 ppm/°C 2mΩ ±100 ppm/°C 3mΩ ≤ R ≤ 1Ω ±50 ppm/°C
		0815	1/2W				1mΩ ≤ R ≤ 100mΩ ±75 ppm/°C ±100 ppm/°C
			1W				

Note: Please contact with sales offices, distributors and representatives in your region before ordering

Environmental characteristics			
Performance test	Test method	Procedure	Requirements
Life	MIL-STD-202 Method 108A	1000 hours at 70 ±2°C applied RCWV 1.5 hours on, 0.5 hours off, still air required	± (1% +0.5mΩ)
High temperature exposure	MIL-STD-202 Method 108A	1000 hours at maximum operating temperature depending on specification, unpowered	± (1% +0.5mΩ)
Moisture resistance	MIL-STD-202 Method 106G	Each temperature / humidity cycle is defined as 8 hours (method 106G), 3 cycles / 24 hours for 10d with 25°C / 65°C 95% R.H	± (0.5% +0.5mΩ)
Solderability	Wetting	J-STD-002B test B Electrical test not required. Magnification 50X Lead-free solder bath at 245 ±3°C Dipping time: 3 ±0.5 seconds	Well tinned (≥ 95% covered)
	Resistance to soldering heat	MIL-STD-202 method 210F Lead-free solder, 260°C, 10 seconds immersion time	± (0.5% +0.5mΩ) No visible damage
Short time overload	IEC 60115-1 4.13	5 times of rated power for 5 seconds at room temperature	± (0.5% +0.5mΩ) No visible damage

Global part number - Preferred type

Ordering example: PE0612FKF070R01L

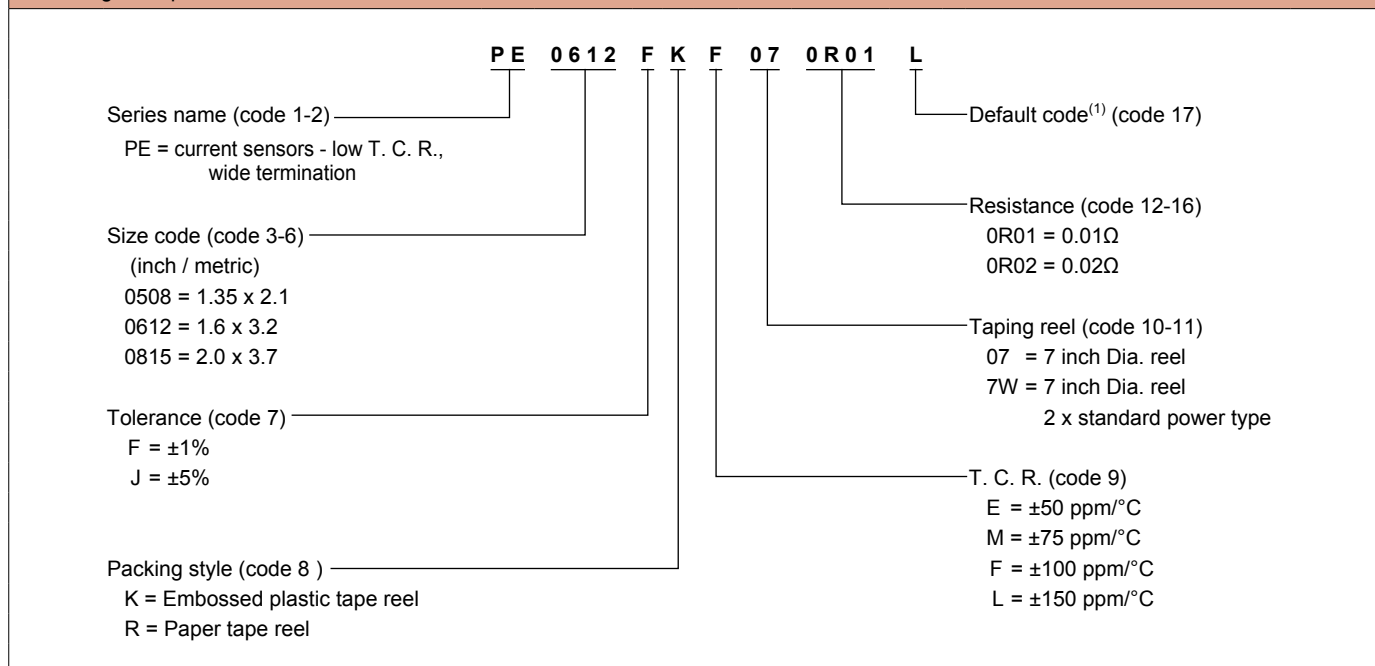

Note: 1. All of our RSMD products are RoHS compliant. "LFP" of the internal 2D reel label mentions "Lead Free Process"



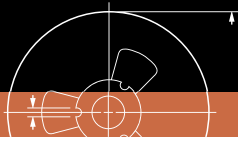

Chip Resistors Selection Charts

PS - Current sensors - low T.C.R. chip resistors, 4 termination, 0306 / 0612 / 1206

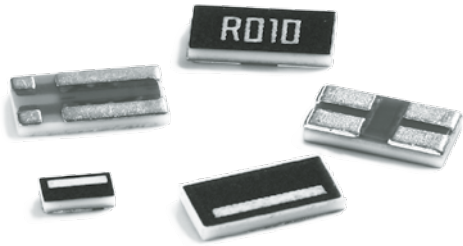

Features

- Excellent T. C. R. compared to thick film low ohmic
- Precision current sensing control
- Excellent performance for current sensing applications
- Ultra-low resistance and narrow tolerance are suitable for current detection

Derating curve (PS 0306 / 0612)

Maximum dissipation (P) in percentage of rated power as a function of the operating ambient temperature (T_{amb}).

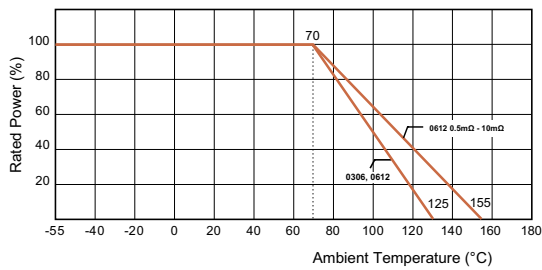

Construction (PS 0306 / 0612)

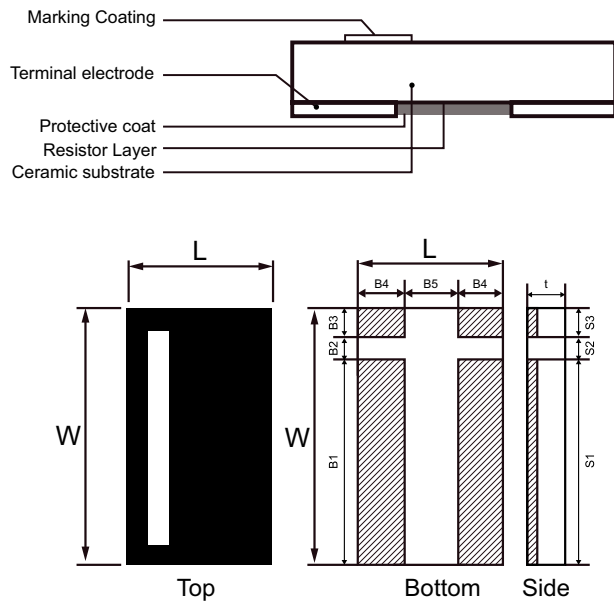

Derating curve (PS 1206)

PS1206 Derating curve (-40 ~ 125°C)

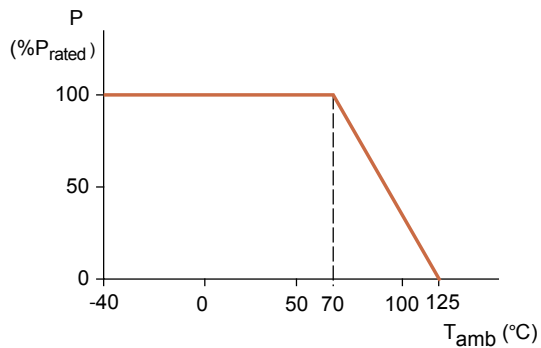

Construction (PS 1206)

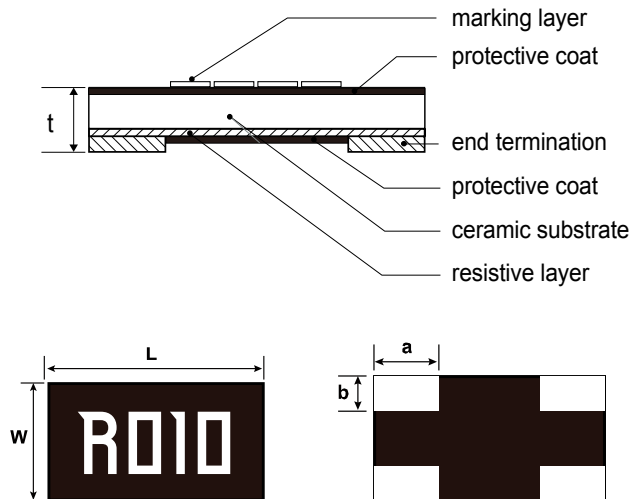

Chip Resistors Selection Charts

PS - Current sensors - low T.C.R. chip resistors, 4 termination, 0306 / 0612 / 1206

Dimensions									
									unit: mm
Type	Resistance range	L	W	B1/S1	B2/S2	B3/S3	B4	B5	t
PS0306	$5\text{m}\Omega \leq R \leq 100\text{m}\Omega$	0.80 ±0.15	1.60 ±0.20	1.10 ±0.20	0.25 ±0.10	0.25 ±0.10	0.20 ±0.10	0.40 ±0.20	0.50 ±0.20
PS0612	$0.5\text{m}\Omega \leq R \leq 1\text{m}\Omega$	1.60±0.15 /-0.20	3.20 ±0.20	2.20 ±0.20	0.50 ±0.20	0.50 ±0.20	0.45 ±0.20	0.70 ±0.20	0.70 ±0.20
	$2\text{m}\Omega \leq R \leq 10\text{m}\Omega$								0.60 ±0.20
	$12\text{m}\Omega \leq R \leq 100\text{m}\Omega$								0.50 ±0.20
Type	Resistance range	L	W	a	b	t			
PS1206	$10\text{m}\Omega \leq R \leq 100\text{m}\Omega$	3.20±0.20	1.60±0.20	1.00±0.20	0.55±0.20	1.60±0.20			

Electrical characteristics							
Type	Technology	Size	Power P ₇₀	Operating Temp. range	Max. working voltage	Tolerance	Resistance range & T. C. R.
PS	Metal Foil 4 termination	0306	1/4W	-55°C to 125°C	(P×R) ^{1/2}	±1%, ±5%	$5\text{m}\Omega \leq R \leq 100\text{m}\Omega$ ±75 ppm/°C ±100 ppm/°C
			1/3W				$3\text{m}\Omega \leq R < 5\text{m}\Omega$ ±150 ppm/°C
			1/2W				
		0612	1W	$0.5\text{m}\Omega \sim 10\text{m}\Omega$ -55°C to +150°C $12\text{m}\Omega \sim 100\text{m}\Omega$ -55°C to +125°C			$0.5\text{m}\Omega \leq R \leq 1\text{m}\Omega$ ±150 ppm/°C $2\text{m}\Omega \leq R \leq 9\text{m}\Omega$ ±100 ppm/°C $14\text{m}\Omega \leq R \leq 100\text{m}\Omega$ ±100 ppm/°C $10\text{m}\Omega \leq R \leq 13\text{m}\Omega$ ±200 ppm/°C
		1206	1/2W	-40°C to 125°C		±0.5%, ±1%, ±5%	$10\text{m}\Omega \leq R \leq 100\text{m}\Omega$ ±50 ppm/°C ±75 ppm/°C ±100 ppm/°C

Note: Please contact with sales offices, distributors and representatives in your region before ordering

Environmental characteristics				
Performance test		Test method	Procedure	Requirements
Life		MIL-STD-202 Method 108A	1000 hours at 70 ±2°C applied RCWV 1.5 hours on, 0.5 hours off, still air required	± (1% +0.5mΩ)
High temperature exposure		MIL-STD-202 Method 108A	1000 hours at maximum operating temperature depending on specification, unpowered	± (1% +0.5mΩ)
Moisture resistance		MIL-STD-202 Method 106G	Each temperature / humidity cycle is defined as 8 hours (method 106G), 3 cycles / 24 hours for 10d with 25°C / 65°C 95% R.H	± (0.5% +0.5mΩ)
Solderability	Wetting	J-STD-002B test B	Electrical test not required. Magnification 50X Lead-free solder bath at 245 ±3°C Dipping time: 3 ±0.5 seconds	Well tinned (≥ 95% covered)
	Resistance to soldering heat	MIL-STD-202 method 210F	Lead-free solder, 260°C, 10 seconds immersion time	± (0.5% +0.5mΩ) No visible damage
Short time overload		IEC 60115-1 4.13	5 times of rated power for 5 seconds at room temperature	PS0306: ± (0.5% +0.5mΩ) PS0612: ± (0.5% +0.5mΩ) PS1206: ± (1% +0.5mΩ) No visible damage



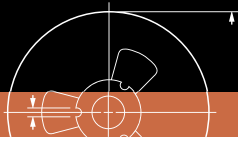

Chip Resistors Selection Charts

PS - Current sensors - low T.C.R. chip resistors, 4 termination, 0306 / 0612 / 1206

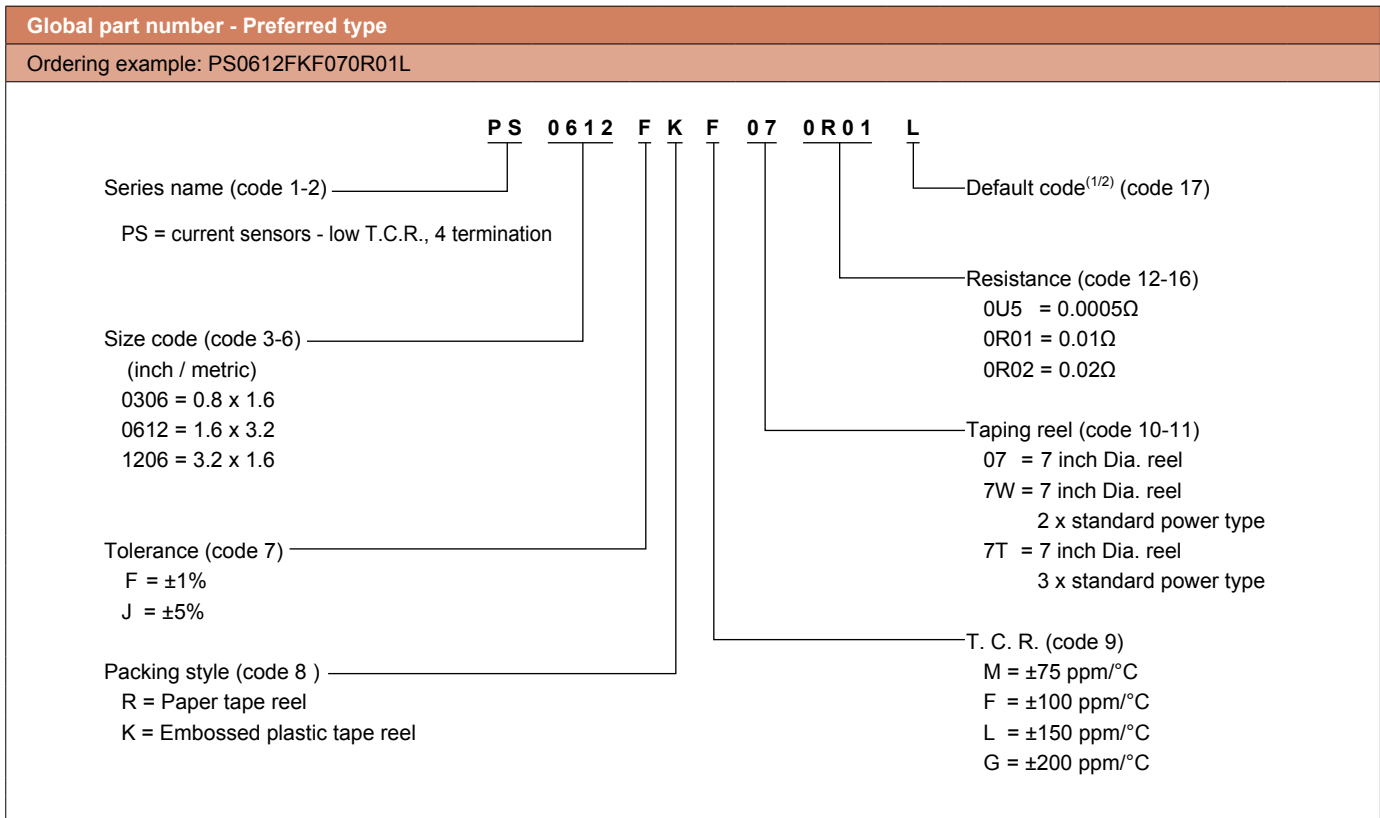

Note: 1. All of our RSMD products are RoHS compliant. "LFP" of the internal 2D reel label mentions "Lead Free Process"
 2. PS series 4 termination type products are available by "Global part number" only



Chip Resistors Selection Charts

PU - Shunt chip resistors, 2512 / 3921 / 5931

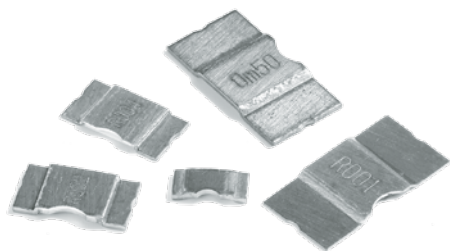

Features

- Resistance value down to 0.0001Ω and high power to 15(W)
- 85°C/85% for high temperature & high humidity
- Welded metal plate construction

Derating curve	Construction
<p>Maximum dissipation (P) in percentage of rated power as a function of the operating ambient temperature (T_{amb}).</p> <p>Normal Temperature Range: -65°C to $+170^{\circ}\text{C}$ High Temperature Range: -65°C to $+275^{\circ}\text{C}$</p>	

Dimensions							
unit: mm							
Type	L	W	H	T	a	b	l
PU2512	6.35 ± 0.25	3.18 ± 0.25	0.35 ± 0.15	1.14 ± 0.25	1.80	3.40	3.40
PU3921	10.00 ± 0.25	5.20 ± 0.25	0.50 ± 0.13	2.00 ± 0.25	2.75 ± 0.25	6.20 ± 0.25	5.60 ± 0.13
PU5931	15.00 ± 0.25	7.75 ± 0.25	0.50 ± 0.13	5.20 ± 0.25	5.20 ± 0.25	8.75 ± 0.25	5.60 ± 0.13





Chip Resistors Selection Charts

PU - Shunt chip resistors, 2512 / 3921 / 5931

Electrical characteristics							
Type	Size	Power P ₇₀	Max voltage	Operating Temp. range	Resistance range	Tolerance	TCR
PU	2512	4W	(PxR) ^{1/2}	-55°C to 170°C	3mΩ/ 4mΩ/ 5mΩ 1mΩ/ 2mΩ 0.3mΩ/ 0.5mΩ	±1% ±5%	0.3mΩ/ 0.5mΩ ±200 ppm/°C 1mΩ ±175 ppm/°C 2mΩ~5mΩ ±75 ppm/°C
		5W					
		6W					
	3921	3W		-65°C to 170°C	0.2mΩ/ 0.25mΩ/ 0.3mΩ/ 0.4mΩ/ 0.5mΩ/ 0.7mΩ 1mΩ/ 2mΩ/ 3mΩ/ 4mΩ/ 5mΩ	±1% ±5%	0.2mΩ/ 0.25mΩ/ 0.3mΩ/ 0.4mΩ/ 0.5mΩ/ 0.7mΩ ±175 ppm/°C 1mΩ~5mΩ ±75 ppm/°C
		5W					
		9W					
		3W					
	5931	5W		-65°C to 170°C	0.2mΩ/ 0.3mΩ/ 0.5mΩ/ 1mΩ/ 2mΩ/ 3mΩ/ 4mΩ	±1% ±5%	0.2mΩ ±225 ppm/°C 0.3mΩ/ 0.5mΩ ±175 ppm/°C 1mΩ~4mΩ ±75 ppm/°C
		7W					
		10W					
		15W					
		5W					
				-65°C to 275°C	0.5mΩ/1mΩ/ 2mΩ/ 3mΩ/ 4mΩ		0.5mΩ ±175 ppm/°C 1mΩ~4mΩ ±75 ppm/°C
				-65°C to 275°C	0.3mΩ/0.5mΩ/ 1mΩ/ 2mΩ/ 3mΩ/ 4mΩ		0.3mΩ/ 0.5mΩ ±175 ppm/°C 1mΩ~4mΩ ±75 ppm/°C

Note: Please contact with sales offices, distributors and representatives in your region before ordering

Environmental characteristics				
Performance test		Test method	Procedure	Requirements
Life		AEC-Q200 Test 8 MIL-STD-202 method 108A IEC 60115-1 4.25.1	1000 hours at 70 ±2°C applied RCWV 1.5 hours on, 0.5 hours off, still air required	±(1% +0.5mΩ)
High temperature exposure		AEC-Q200 Test 3 MIL-STD-202 method 108A IEC 60115-1 4.25.3	1000 hours at maximum operating temperature depending on specification, unpowered	±(1% +0.5mΩ)
Moisture resistance		AEC-Q200 Test 6 MIL-STD-202 method 106F	Each temperature / humidity cycle is defined as 8 hours (method 106G), 3 cycles / 24 hours for 10d with 25°C / 65°C 95% R.H	±(1% +0.5mΩ)
Solderability	Resistance to soldering heat	AEC-Q200 Test 15 MIL-STD-202 method 210F IEC 60115-1 4.18	Lead-free solder, 260°C, 10 seconds immersion time	±(0.5% +0.5mΩ) No visible damage
Short time overload		IEC 60115-1 4.13	5 times of rated power for 5 seconds at room temperature	±(1% +0.5mΩ) No visible damage



Chip Resistors Selection Charts

PU - Shunt chip resistors, 2512 / 3921 / 5931

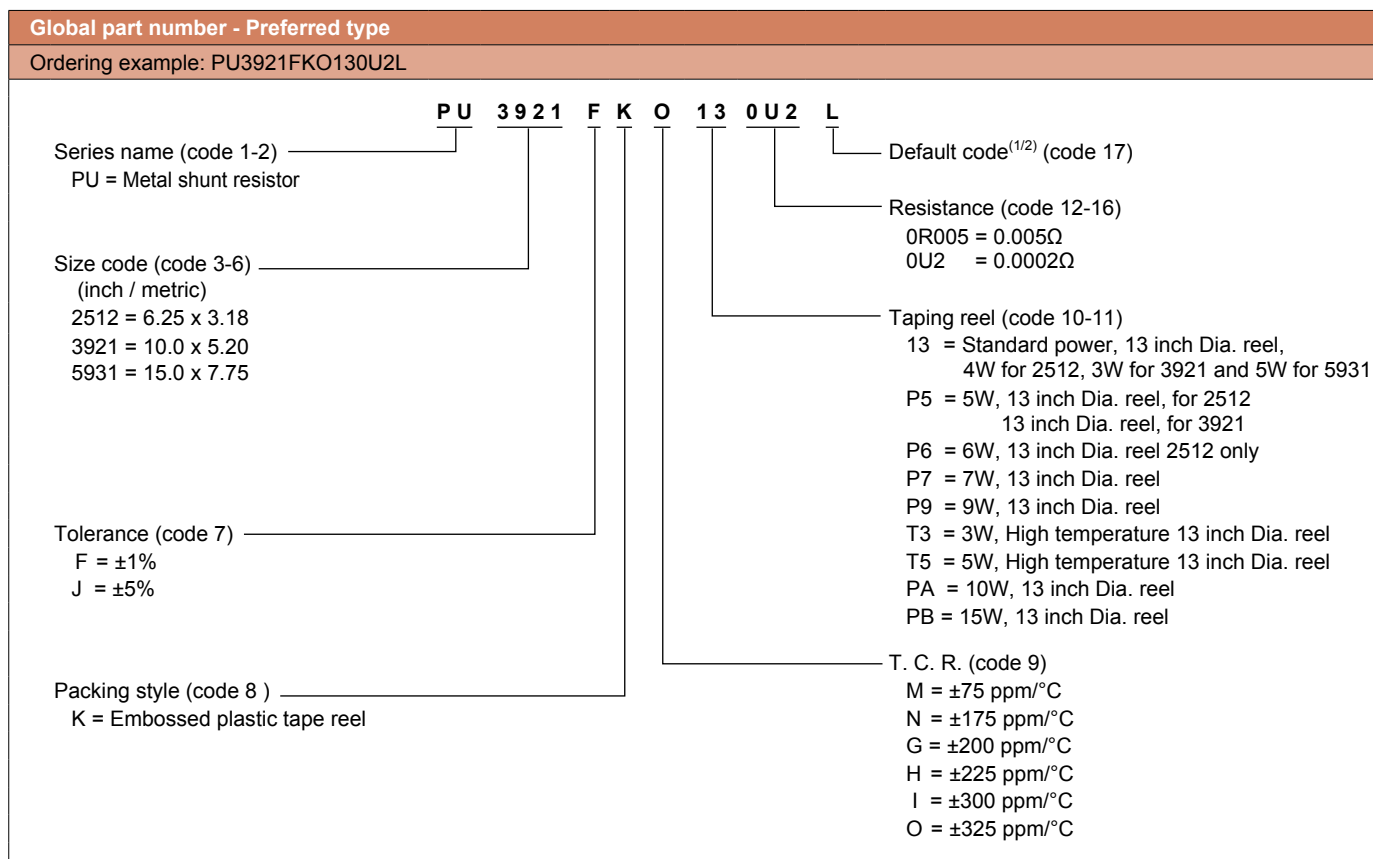

Note: 1. All of our RSMD products are RoHS compliant. "LFP" of the internal 2D reel label mentions "Lead Free Process"
2. PU series 4 termination type products are available by "Global part number" only

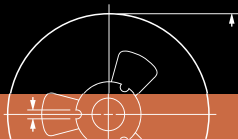

Chip Resistors Selection Charts

PU - Shunt chip resistors, 6820



Features

- Resistance value down to 0.0001Ω and high power to 36(W)
- 85°C/ 85% for high temperature & high humidity
- Welded metal plate construction

Derating curve	Construction
<p>Maximum dissipation (P) in percentage of rated power as a function of the operating ambient temperature (T_{amb}).</p> <p>Temperature Range: -65°C to $+170^{\circ}\text{C}$</p> <p style="text-align: center;"> — Improved stability < 0.5% --- Stability < 1% </p>	

Dimensions							
	L	W	D1	T1	T2	A	D2
unit: mm							
PU6820	68.0 ± 0.2	20.0 ± 0.1	51.0 ± 0.2	3.0 ± 0.1	2.1 ± 0.3	10.0 ± 0.5	18.2 ± 0.13



Chip Resistors Selection Charts

PU - Shunt chip resistors, 6820

Electrical characteristics							
Type	Size	Power P_{70}	Max voltage	Operating Temp. range	Resistance range	Tolerance	TCR
PU	6820	36W	$(P \times R)^{1/2}$	-65°C to 170°C	0.1mΩ	±5%	±100 ppm/°C

Note: Please contact with sales offices, distributors and representatives in your region before ordering

Environmental characteristics			
Performance test	Test method	Procedure	Requirements
Life	AEC-Q200 Test 8 MIL-STD-202 method 108A IEC 60115-1 4.25.1	1000 hours at 70 ±2°C applied RCWV 1.5 hours on, 0.5 hours off, still air required	±(1%+0.005mΩ)
High temperature exposure	AEC-Q200 Test 3 MIL-STD-202 method 108A IEC 60115-1 4.25.3	1000 hours at maximum operating temperature depending on specification, unpowered	±(1%+0.005mΩ)
Moisture resistance	AEC-Q200 Test 6 MIL-STD-202 method 106F	Each temperature / humidity cycle is defined as 8 hours (method 106G), 3 cycles / 24 hours for 10d with 25°C / 65°C 95% R.H	±(0.5%+0.005mΩ)
Short time overload	IEC 60115-1 4.13	5 times of rated power for 5 seconds at room temperature	±(0.5%+0.005mΩ) No visible damage

Global part number - Preferred type	
Ordering example: PU6820JKF070U1L	
<p>Series name (code 1-2) ———— PU</p> <p>PU = Metal shunt resistor</p> <p>Size code (code 3-6) ———— 6820</p> <p>6820 = 68.0 x 20.0</p> <p>Tolerance (code 7) ———— J</p> <p>J = ±5%</p> <p>Packing style (code 8) ———— K</p> <p>K = Vacuum Packing</p>	<p>F ———— T. C. R. (code 9)</p> <p>F = ±100 ppm/°C</p> <p>07 ———— Taping reel (code 10-11)</p> <p>07 = Standard power, 36W</p> <p>0U1 ———— Resistance (code 12-16)</p> <p>0U1 = 0.0001Ω</p> <p>L ———— Default code (code 17)</p>

Note: 1. All of our RSMD products are RoHS compliant. "LFP" of the internal 2D reel label mentions "Lead Free Process"
2. PU series type products are available by "Global part number" only



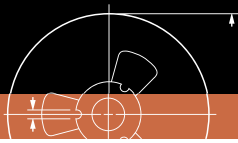

Chip Resistors Selection Charts

PU - Shunt chip resistors, 8420 / 8518



Features

- Resistance value down to 0.00005Ω and high power to 36(W)
- 85°C/ 85% for high temperature & high humidity
- Welded metal plate construction

Derating curve	Construction
<p>Maximum dissipation (P) in percentage of rated power as a function of the operating ambient temperature (T_{amb}).</p> <p>8420 Temperature Range: -40°C to +170°C 8518 Temperature Range: -65°C to +170°C</p>	<p>8420</p> <p>8518</p>

Dimensions

unit: mm

	Resistance Value	L	W	D	T1	T2	A	B
PU8420	0.05mΩ	84.0 ± 0.15	20.0 ± 0.10	60.0 ± 0.20	3.0 ± 0.15	2.3 ± 0.20	5.0 ± 0.50	8.2 ± 0.10
	0.1mΩ	84.0 ± 0.15	20.0 ± 0.10	60.0 ± 0.20	3.0 ± 0.15	2.3 ± 0.20	10.1 ± 0.50	13.2 ± 0.10
PU8518	0.05mΩ	85.0 ± 0.40	18.0 ± 0.20	60.0 ± 0.10	3.0 ± 0.10	2.0 ± 0.10	3.68 ± 0.10	8.71 ± 0.13
	0.1mΩ	85.0 ± 0.40	18.0 ± 0.20	60.0 ± 0.10	3.0 ± 0.10	2.0 ± 0.10	9.40 ± 0.10	12.57 ± 0.13
	0.125mΩ	85.0 ± 0.40	18.0 ± 0.20	60.0 ± 0.10	3.0 ± 0.10	2.0 ± 0.10	12.19 ± 0.10	15.37 ± 0.13
	0.25mΩ	85.0 ± 0.40	18.0 ± 0.20	60.0 ± 0.10	3.0 ± 0.10	2.0 ± 0.10	22.86 ± 0.10	26.04 ± 0.13



Chip Resistors Selection Charts

PU - Shunt chip resistors, 8420 / 8518

Electrical characteristics							
Type	Size	Power P ₇₀	Max voltage	Operating Temp. range	Resistance range	Tolerance	TCR
PU	8518	36W	(PxR) ^{1/2}	-65°C to 170°C	0.05mΩ / 0.1mΩ / 0.125mΩ / 0.25mΩ	±5% ±10%	0.05mΩ ±200ppm/°C 0.1 / 0.125mΩ ±175ppm/°C 0.25mΩ ±100ppm/°C
	8420	36W		-40°C to 170°C	0.05mΩ / 0.1mΩ	±5%	±50ppm/°C

Note: Please contact with sales offices, distributors and representatives in your region before ordering

Environmental characteristics			
Performance test	Test method	Procedure	Requirements
Life	AEC-Q200 Test 8 MIL-STD-202 method 108A IEC 60115-1 4.25.1	1000 hours at 70 ±2°C applied RCWV 1.5 hours on, 0.5 hours off, still air required	±(1%+0.005mΩ)
High temperature exposure	AEC-Q200 Test 3 MIL-STD-202 method 108A IEC 60115-1 4.25.3	1000 hours at maximum operating temperature depending on specification, unpowered	±(1%+0.005mΩ)
Moisture resistance	AEC-Q200 Test 6 MIL-STD-202 method 106F	Each temperature / humidity cycle is defined as 8 hours (method 106G), 3 cycles / 24 hours for 10d with 25°C / 65°C 95% R.H	±(0.5%+0.005mΩ)
Short time overload	IEC 60115-1 4.13	5 times of rated power for 5 seconds at room temperature	±(0.5%+0.005mΩ) No visible damage

Global part number - Preferred type	
Ordering example: PU8420JKE070U1L	
<p>Series name (code 1-2) PU = Metal shunt resistor</p> <p>Size code (code 3-6) (inch / metric) 8420 = 84.0 x 20.0 8518 = 85.0 x 18.0</p> <p>Tolerance (code 7) J = ±5% K = ±10%</p> <p>Packing style (code 8) K = Vacuum Packing</p>	<p>Default code^(1/2) (code 17) L</p> <p>Resistance (code 12-16) 0U05 = 0.00005Ω 0U1 = 0.0001Ω</p> <p>Taping reel (code 10-11) 07 = Standard power, 36W</p> <p>T. C. R. (code 9) E = ±50 ppm/°C F = ±100 ppm/°C N = ±175 ppm/°C G = ±200 ppm/°C</p>

Note: 1. All of our RSMD products are RoHS compliant. "LFP" of the internal 2D reel label mentions "Lead Free Process"
2. PU series type products are available by "Global part number" only



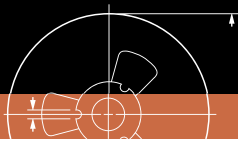

Chip Resistors Selection Charts

PU - Shunt chip resistors, 8420_E

Features

- Resistance value down to 0.0001Ω and high power to 15(W)
- 85°C/ 85% for high temperature & high humidity
- Welded metal plate construction

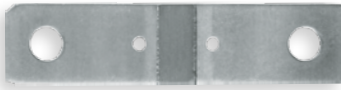

Derating curve

Maximum dissipation (P) in percentage of rated power as a function of the operating ambient temperature (T_{amb}).

Temperature Range: -40°C to +170°C

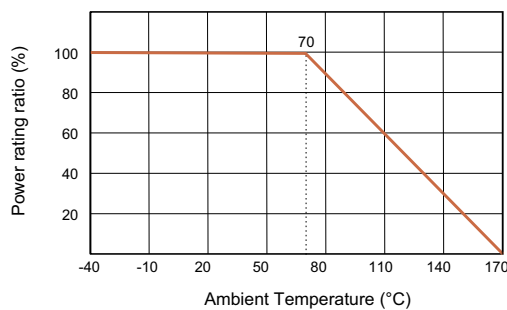

Construction

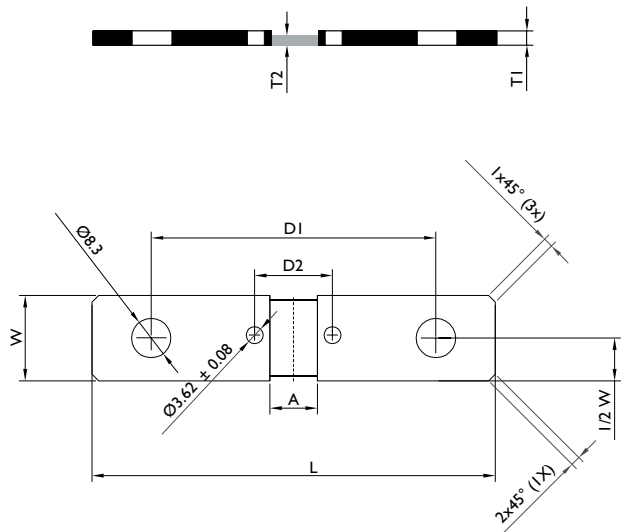

Dimensions

unit: mm

	Hole Distance	L	W	D1	T1	T2	A	D2
PU8420_E	60mm	84.0 ± 0.15	20.0 ± 0.10	60.0 ± 0.20	3.0 ± 0.15	2.3 ± 0.20	10.1 ± 0.50	18.2 ± 0.10
	64mm	84.0 ± 0.15	20.0 ± 0.10	64.0 ± 0.20	3.0 ± 0.15	2.3 ± 0.20	10.1 ± 0.50	18.2 ± 0.10



Chip Resistors Selection Charts

PU - Shunt chip resistors, 8420_E

Electrical characteristics							
Type	Size	Power P_{70}	Max voltage	Operating Temp. range	Resistance range	Tolerance	TCR
PU	8420_E	15W	$(P \times R)^{1/2}$	-40°C to 170°C	0.1mΩ	±5%	±50 ppm/°C

Note: Please contact with sales offices, distributors and representatives in your region before ordering

Environmental characteristics			
Performance test	Test method	Procedure	Requirements
Life	AEC-Q200 Test 8 MIL-STD-202 method 108A IEC 60115-1 4.25.1	1000 hours at 70 ±2°C applied RCWV 1.5 hours on, 0.5 hours off, still air required	±(1%+0.005mΩ)
High temperature exposure	AEC-Q200 Test 3 MIL-STD-202 method 108A IEC 60115-1 4.25.3	1000 hours at maximum operating temperature depending on specification, unpowered	±(1%+0.005mΩ)
Moisture resistance	AEC-Q200 Test 6 MIL-STD-202 method 106F	Each temperature / humidity cycle is defined as 8 hours (method 106G), 3 cycles / 24 hours for 10d with 25°C / 65°C 95% R.H	±(0.5%+0.005mΩ)
Short time overload	IEC 60115-1 4.13	5 times of rated power for 5 seconds at room temperature	±(0.5%+0.005mΩ) No visible damage

Global part number - Preferred type

Ordering example: PU8420JKE600U1E

<p>Series name (code 1-2) PU = Metal shunt resistor</p> <p>Size code (code 3-6) 8420 = 84.0 x 20.0</p> <p>Tolerance (code 7) J = ±5%</p> <p>Packing style (code 8) K = Vacuum Packing</p>	<p>PU 8420 J K E 60 0U1 E</p>	<p>Default code for 4 holes (code 17)</p> <p>Resistance (code 12-16) 0U1 = 0.0001Ω</p> <p>Hole Distance (code 10-11) 60 = Standard power 15W, D1= 60mm 64 = Standard power 15W, D1= 64mm</p> <p>T. C. R. (code 9) E = ±50 ppm/°C</p>
---	--------------------------------------	--

Note: 1. All of our RSMD products are RoHS compliant. "LFP" of the internal 2D reel label mentions "Lead Free Process"
2. PU series type products are available by "Global part number" only



Chip Resistors Selection Charts

PU - Shunt chip resistors, 8420_N

Features

- Resistance value down to 0.000035Ω and high power to 15(W)
- 85°C/ 85% for high temperature & high humidity
- Welded metal plate construction



Derating curve

Maximum dissipation (P) in percentage of rated power as a function of the operating ambient temperature (T_{amb}).

Temperature Range: -40°C to +170°C

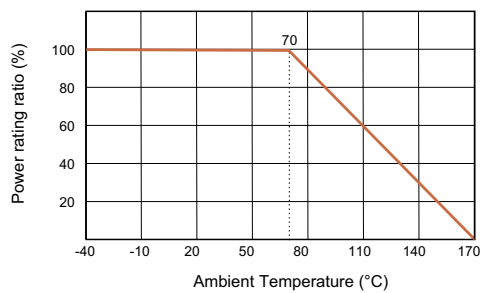

Construction

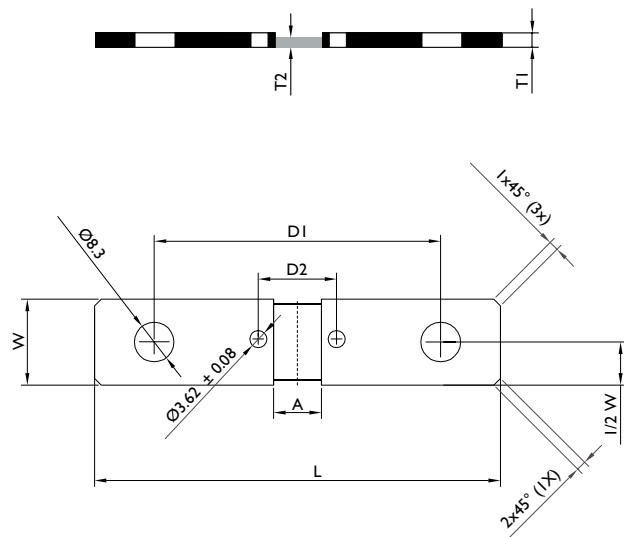

Dimensions

unit: mm

	Hole Distance	L	W	D1	T1	T2	A	D2
PU8420_N	64mm	84.0 ± 0.15	20.0 ± 0.10	64.0 ± 0.20	3.0 ± 0.15	2.3 ± 0.20	5.3 ± 0.30	18.2 ± 0.10



Chip Resistors Selection Charts

PU - Shunt chip resistors, 8420_N

Electrical characteristics							
Type	Size	Power P ₇₀	Max voltage	Operating Temp. range	Resistance range	Tolerance	TCR
PU	8420_N	15W	(P×R) ^{1/2}	-40°C to 170°C	0.035mΩ	±5%	±250 ppm/°C

Note: Please contact with sales offices, distributors and representatives in your region before ordering

Environmental characteristics			
Performance test	Test method	Procedure	Requirements
Life	AEC-Q200 Test 8 MIL-STD-202 method 108A IEC 60115-1 4.25.1	1000 hours at 70 ±2°C applied RCWV 1.5 hours on, 0.5 hours off, still air required	±(1%+0.005mΩ)
High temperature exposure	AEC-Q200 Test 3 MIL-STD-202 method 108A IEC 60115-1 4.25.3	1000 hours at maximum operating temperature depending on specification, unpowered	±(1%+0.005mΩ)
Moisture resistance	AEC-Q200 Test 6 MIL-STD-202 method 106F	Each temperature / humidity cycle is defined as 8 hours (method 106G), 3 cycles / 24 hours for 10d with 25°C / 65°C 95% R.H	±(0.5%+0.005mΩ)
Short time overload	IEC 60115-1 4.13	5 times of rated power for 5 seconds at room temperature	±(0.5%+0.005mΩ) No visible damage

Global part number - Preferred type	
Ordering example: PU8420JKP640U035N	
<p>Series name (code 1-2) ———— PU</p> <p>PU = Metal shunt resistor</p> <p>Size code (code 3-6) ———— 8420</p> <p>8420 = 84.0 x 20.0</p> <p>Tolerance (code 7) ———— J</p> <p>J = ±5%</p> <p>Packing style (code 8) ———— K</p> <p>K = Vacuum Packing</p>	<p>Letter N is 4 holes and Ni/Sn, plating on the Top and bottom (code 17)</p> <p>Resistance (code 12-16)</p> <p>0U035 = 0.000035Ω</p> <p>Hole Distance (code 10-11)</p> <p>64 = Standard power 15W, D1= 64mm</p> <p>T. C. R. (code 9)</p> <p>P = ±250 ppm/°C (20°C ~ 60°C)</p>

Note: 1. All of our RSMD products are RoHS compliant. "LFP" of the internal 2D reel label mentions "Lead Free Process"
2. PU series type products are available by "Global part number" only



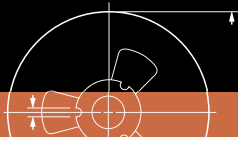

Chip Resistors Selection Charts

AR - NiAu termination chip resistors, 0402 to 1206



Features

- New NiAu terminations provide special application for hybrid board gluing
- Competitive with NiAu terminations
- Special use in high temperature environment
- Higher component and equipment reliability

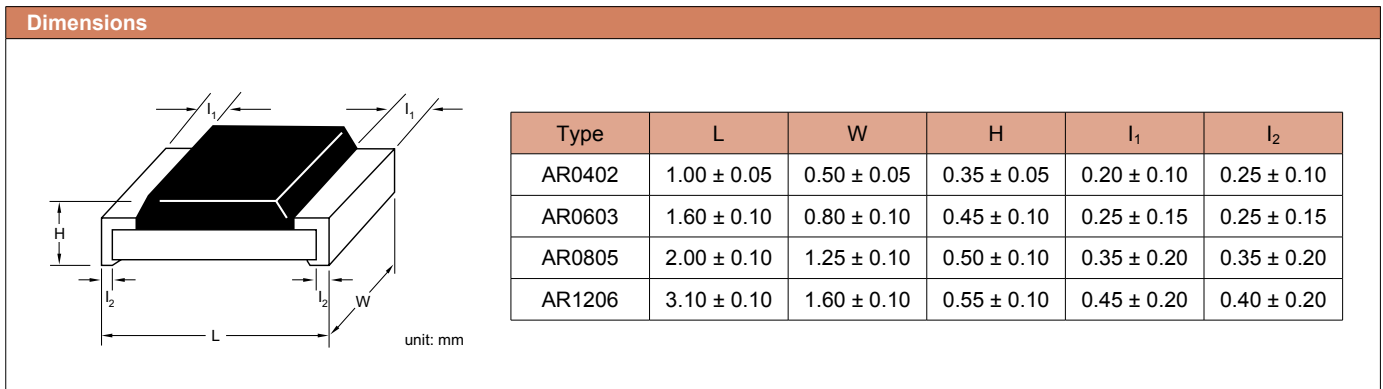
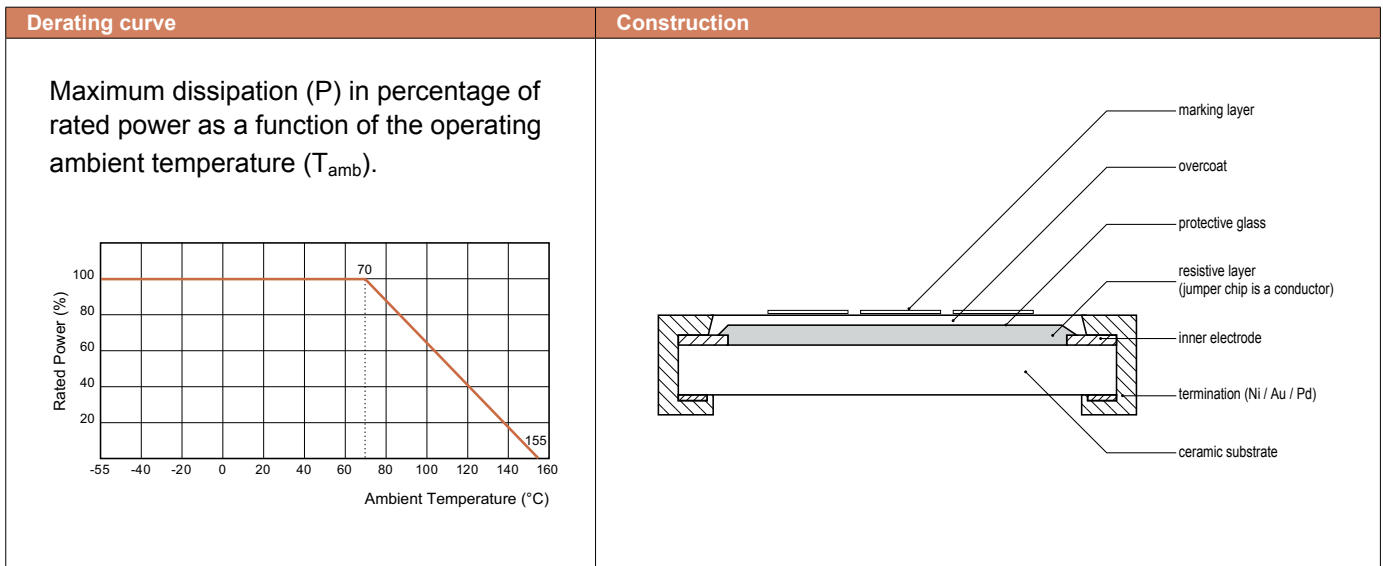

Electrical characteristics								
Type	Power P_{70}	Operating Temp. range	MWV	RCOV	DWV	Resistance range & tolerance	T. C. R.	Jumper criteria (unit: A)
AR0402	1/16W	-55°C to +155°C	50V	100V	100V	E24 $\pm 5\%$ $1\Omega \leq R \leq 10M\Omega$ E24/E96 $\pm 1\%$ $1\Omega \leq R \leq 10M\Omega$ Jumper < 50m Ω	$10\Omega < R \leq 10M\Omega$ ± 100 ppm/°C $1\Omega \leq R \leq 10\Omega$ ± 200 ppm/°C	Rated current 1.0 Max. current 2.0
AR0603	1/10W		50V	100V	100V			Rated current 1.0 Max. current 2.0
AR0805	1/8W		150V	300V	300V			Rated current 2.0 Max. current 5.0
AR1206	1/4W		200V	500V	500V			Rated current 2.0 Max. current 10.0



Chip Resistors Selection Charts

AR - NiAu termination chip resistors, 0402 to 1206

Environmental characteristics				
Performance test		Test method	Procedure	Requirements
Life		MIL-STD-202 -method 108A	1000 hours at 70 ±2°C applied RCWV 1.5 hours on, 0.5 hours off, still air required	± (2% +50mΩ) < 100mΩ for jumper
High temperature exposure		MIL-STD-202 -method 108A	1000 hours at maximum operating temperature depending on specification, unpowered	± (1% +50mΩ) < 50mΩ for jumper
Moisture resistance		MIL-STD-202 -method 106F	Each temperature / humidity cycle is defined as 8 hours (method 106F), 3 cycles / 24 hours for 10d with 25°C / 65°C 95% R.H	± (2% +50mΩ) < 100mΩ for jumper
Thermal shock		MIL-STD-202 -method 107G	-55/ +125°C Note: Number of cycles required is 300. Devices mounted Maximum transfer time is 20 seconds. Dwell time is 15 minutes. Air – Air	± (0.5% +50mΩ) for 10K to 10M ± (1% +50mΩ) for others < 50mΩ for jumper
Solderability	Wetting	J-STD-002B test B	Electrical test not required. Magnification 50X Lead-free solder bath at 245 ±3°C Dipping time: 3 ±0.5 seconds	Well tinned (≥ 95% covered) No visible damage
	Resistance to soldering heat	MIL-STD-202 -method 107G	Lead-free solder, 260°C, 10 seconds immersion time	± (1% +50mΩ) < 50mΩ for jumper No visible damage
Short time overload		MIL-R-55342D -para 4.7.5	2.5 times RCWV or maximum overload voltage whichever is less for 5 seconds at room temperature	± (2% +50mΩ) < 50mΩ for jumper No visible damage

Global part number - Preferred type for ordering Yageo / Phycomp branded products

Ordering example: AR0603JR-07100KL

AR 0603 JR - 07 100K L	
Series name (code 1-2) AR = NiAu termination	Default code ^(1/2) (code 17)
Size code (code 3-6) (inch / metric) 0402 = 1.0 x 0.5 0603 = 1.6 x 0.8 0805 = 2.0 x 1.25 1206 = 3.2 x 1.6	Resistance (code 12-16) 0R = Jumper 10R = 10Ω 100R = 100Ω 100K = 100KΩ
Tolerance (code 7) F = ±1% J = ±5% (for Jumper ordering)	Taping reel (code 10-11) 07 = 7 inch Dia. reel
	T. C. R. (code 9) "_" = Based on spec. (- for thick film only)
	Packing style (code 8) R = Paper tape reel

Note: 1. All of our RSMD products are RoHS compliant. "LFP" of the internal 2D reel label mentions "Lead Free Process"
2. Letter L is system default code for ordering only

Phycomp worldwide - Traditional type

Chip resistors with Ni/Au terminations									
Size: inch (mm)	0402 (1005)		0603 (1608)		0805 (2012)		1206 (3216)		
Power	1/16 W		1/10 W		1/8 W		1/4 W		
Tolerance	+5%	+1%	+5%	+1%	+5%	+1%	+5%	+1%	+1%
Resistance	E24	E24 / E96	E24	E24 / E96	E24	E24 / E96	E24	E24 / E96	E24 / E96
Packing	paper tape		paper tape		paper tape		paper tape		
Quantity	5 000	---	---	2322 702 11...L	2322 704 1...L	2322 730 11...	2322 734 1...L	2322 711 11...L	2322 729 1...L
	10 000	2322 705 12...L	2322 706 2...	---	---	---	---	---	---
Jumper	5 000	---	---	2322 702 19001L	---	2322 730 19001L	---	2322 711 19001L	---
	10 000	2322 705 19001 L	---	---	---	---	---	---	---

For ordering rules: See page 14 for E24 / E96 values and the last 4 or 3 digits of the 12NC catalogue number

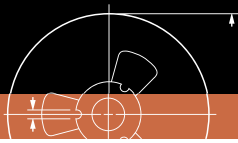

Chip Resistors Selection Charts

TR - Trimmable chip resistors, 0402 to 1206



Features

- Reduced size of final equipment
- Higher component and equipment reliability
- Low noise, when not trimmed
- Flexible for resistance trimming

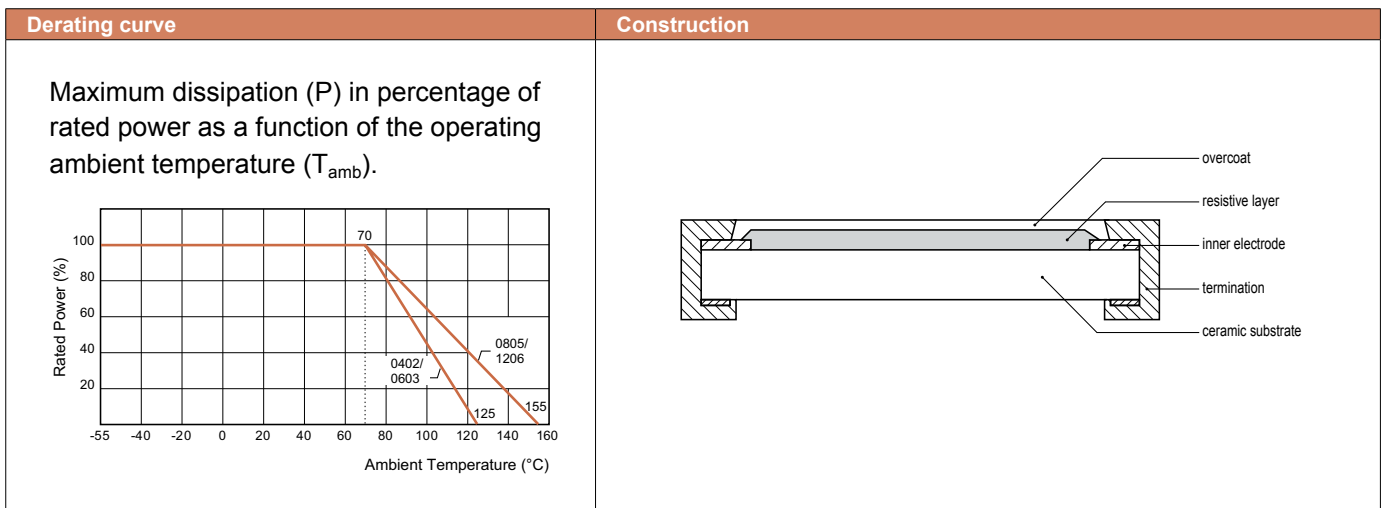

Dimensions																															
<p>unit: mm</p>	<table border="1"> <thead> <tr> <th>Type</th> <th>L</th> <th>W</th> <th>H</th> <th>l_1</th> <th>l_2</th> </tr> </thead> <tbody> <tr> <td>TR0402</td> <td>1.00 ± 0.10</td> <td>0.50 ± 0.05</td> <td>0.35 ± 0.05</td> <td>0.20 ± 0.10</td> <td>0.25 ± 0.10</td> </tr> <tr> <td>TR0603</td> <td>1.60 ± 0.10</td> <td>0.80 ± 0.10</td> <td>0.45 ± 0.10</td> <td>0.25 ± 0.15</td> <td>0.25 ± 0.15</td> </tr> <tr> <td>TR0805</td> <td>2.00 ± 0.10</td> <td>1.25 ± 0.10</td> <td>0.50 ± 0.10</td> <td>0.35 ± 0.20</td> <td>0.35 ± 0.20</td> </tr> <tr> <td>TR1206</td> <td>3.10 ± 0.10</td> <td>1.60 ± 0.10</td> <td>0.55 ± 0.10</td> <td>0.45 ± 0.20</td> <td>0.40 ± 0.20</td> </tr> </tbody> </table>	Type	L	W	H	l_1	l_2	TR0402	1.00 ± 0.10	0.50 ± 0.05	0.35 ± 0.05	0.20 ± 0.10	0.25 ± 0.10	TR0603	1.60 ± 0.10	0.80 ± 0.10	0.45 ± 0.10	0.25 ± 0.15	0.25 ± 0.15	TR0805	2.00 ± 0.10	1.25 ± 0.10	0.50 ± 0.10	0.35 ± 0.20	0.35 ± 0.20	TR1206	3.10 ± 0.10	1.60 ± 0.10	0.55 ± 0.10	0.45 ± 0.20	0.40 ± 0.20
Type	L	W	H	l_1	l_2																										
TR0402	1.00 ± 0.10	0.50 ± 0.05	0.35 ± 0.05	0.20 ± 0.10	0.25 ± 0.10																										
TR0603	1.60 ± 0.10	0.80 ± 0.10	0.45 ± 0.10	0.25 ± 0.15	0.25 ± 0.15																										
TR0805	2.00 ± 0.10	1.25 ± 0.10	0.50 ± 0.10	0.35 ± 0.20	0.35 ± 0.20																										
TR1206	3.10 ± 0.10	1.60 ± 0.10	0.55 ± 0.10	0.45 ± 0.20	0.40 ± 0.20																										

Electrical characteristics							
Type	Power P_{70}	Operating Temp. range	MWV	RCOV	DWV	Resistance range & tolerance	T. C. R.
TR0402	1/16W	-55°C to +125°C	50V	100V	100V	E24 +0/-10%, +0/-20%, +0/-30% $1\Omega \leq R \leq 10M\Omega$	$1\Omega \leq R \leq 10\Omega$ ± 200 ppm/°C $10\Omega < R \leq 1M\Omega$ ± 100 ppm/°C $1M\Omega < R \leq 10M\Omega$ ± 200 ppm/°C
TR0603	1/16W		50V	100V	100V		
TR0805	1/8W	-55°C to +155°C	150V	300V	500V		
TR1206	1/4W		200V	500V	500V		



Chip Resistors Selection Charts

TR - Trimmable chip resistors, 0402 to 1206

Environmental characteristics				
Performance test	Test method	Procedure	Requirements	
Life	MIL-STD-202 Method 108A	1000 hours at 70 ±2°C applied RCWV 1.5 hours on, 0.5 hours off, still air required	± (1% +50mΩ)	
High temperature exposure	MIL-STD-202 Method 108A	1000 hours at maximum operating temperature depending on specification, unpowered	± (1% +50mΩ)	
Moisture resistance	MIL-STD-202 Method 106G	Each temperature / humidity cycle is defined as 8 hours (method 106G), 3 cycles / 24 hours for 10d with 25°C / 65°C 95% R.H	± (2% +50mΩ)	
Thermal shock	MIL-STD-202 Method 107G	-55 / +125°C Note: Number of cycles required is 300. Devices mounted Maximum transfer time is 20 seconds. Dwell time is 15 minutes. Air – Air	± (1% +50mΩ)	
Solderability	Wetting	J-STD-002B test B	Electrical test not required. Magnification 50X Lead-free solder bath at 245 ±3°C Dipping time: 3 ±0.5 seconds	Well tinned (≥ 95% covered) No visible damage
	Resistance to soldering heat	MIL-STD-202 method 210F	Lead-free solder, 260°C, 10 seconds immersion time	± (1% +50mΩ) No visible damage
Short time overload	IEC 60115 -1 4.13	2.5 times RCWV or maximum overload voltage whichever is less for 5 seconds at room temperature	± (1% +50mΩ) No visible damage	

Global part number - Preferred type for ordering Yageo / Phycomp branded products

Ordering example: TR0603MR-07100KL

TR 0603 MR - 07 100K L	
Series name (code 1-2) TR = Trimmable	Default code ^(1/2) (code 17)
Size code (code 3-6) (inch / metric) 0402 = 1.0 x 0.5 0603 = 1.6 x 0.8 0805 = 2.0 x 1.25 1206 = 3.2 x 1.6	Resistance (code 12-16) 10R = 10Ω 100R = 100Ω 100K = 100KΩ
Tolerance (code 7) K = 0/-10% M = 0/-20% N = 0/-30%	Taping reel (code 10-11) 07 = 7 inch Dia. reel
	T. C. R. (code 9) "-" = Based on spec. (- for thick film only)
	Packing style (code 8) R = Paper tape reel

Note: 1. All of our RSMD products are RoHS compliant. "LFP" of the internal 2D reel label mentions "Lead Free Process"
2. Letter L is system default code for ordering only

Phycomp worldwide - Traditional type

Phycomp worldwide - Traditional type				
Trimmable chip resistors				
Size: inch (mm)	0402 (1005)	0603 (1608)	0805 (2012)	1206 (3216)
Power	1/16 W	1/10 W	1/8 W	1/4 W
Tolerance	E24	E24	E24	E24
Resistance	paper tape	paper tape	paper tape	paper tape
Packing	2350 503 21...L	2350 502 11...L	2350 501 11...L	2350 500 11...L
Quantity	5 000 0/-20%	2350 503 20...L	2350 502 10...L	2350 500 10...L
	5 000 0/-30%	on request	on request	on request
Europe	5 000	2322 792 61...L	2322 793 6...L	2322 791 6...L

For ordering rules: See page 14 for E24 / E96 values and the last 4 or 3 digits of the 12NC catalogue number



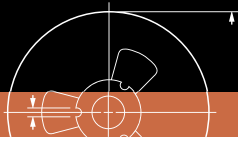

Chip Resistors Selection Charts

ATV - RF attenuator chip resistors, 0404



Features

- Reduce system size
- Low assembly cost
- Higher component and system reliability
- Suitable for applications of mobile phones, receivers, battery chargers and tablets

Derating curve	Construction	Schematics
<p>Maximum dissipation (P) in percentage of rated power as a function of the operating ambient temperature (T_{amb}).</p> <p>Rated Power (%)</p> <p>Ambient Temperature (°C)</p>	<p>The rectangular marker designates input pin 1</p> <p>input signal</p> <p>attenuated output signal</p>	<p style="text-align: center;">ATV 321</p> <p style="text-align: center;">$R1 \neq R2$</p>

Dimensions							
<p style="text-align: center;">unit: mm</p>							
Type	L	W	T	A	B	P	D
ATV321	1.00 ± 0.10	1.00 ± 0.10	0.35 ± 0.05	0.33 ± 0.10	0.15 ± 0.10	0.65 ± 0.10	0.25 ± 0.10



Chip Resistors Selection Charts

ATV - RF attenuator chip resistors, 0404

Electrical characteristics							
Type	Power P ₇₀	Operating Temp. range	MPV	VSWR (Max.)	Impedance	Attenuation range & tolerance	Frequency range
ATV321	40mW	-55°C to +125°C	50V	1.3	50Ω	-1dB to -5dB ±0.3 dB	-1dB to -10dB DC to 2.5 GHz
						-6dB to -10dB ±0.5 dB	
						-15dB ±1.0 dB	-15dB to -20dB DC to 2.0 GHz
						-20dB ±2.0 dB	

Environmental characteristics			
Performance test	Test method	Procedure	Requirements
Life	MIL-STD-202 -method 108A	1000 hours at 70 ±5°C applied RCWV 1.5 hours on, 0.5 hours off, still air required	Max.: ±0.3 dB
Humidity (steady state)	JIS C 5202 7.5	1000 hours, 40 ±2°C, 93(+2/-3)% RH RCWV applied for 1.5 hours on and 0.5 hour off	Max.: ±0.3 dB
Moisture resistance	MIL-STD-202 -method 106F	Each temperature / humidity cycle is defined as 8 hours (method 106F), 3 cycles / 24 hours for 10d with 25°C / 65°C 95% R.H	Max.: ±0.3 dB
Thermal shock	MIL-STD-202 -method 107G	LCT / UCT, number of cycles required is 300 Maximum transfer time is 20 seconds	Max.: ±0.3 dB
Solderability	Wetting	J-STD-002B Test B Electrical test not required. Magnification 50X Lead-free solder bath at 245 ±3°C Dipping time: 3 ±0.5 seconds	Well tinned (≥ 95% covered)
	Resistance to soldering heat	MIL-STD-202 -method 210F Lead-free solder, 260°C, 10 seconds immersion time	Max.: ±0.1 dB
Short time overload	MIL-R-55342D -para 4.7.5	2.5 times RCWV or maximum overload voltage whichever is less for 5 seconds at room temperature	Max.: ±0.3 dB

Global part number - Preferred type for ordering Yageo / Phycomp branded products

Ordering example: ATV321CR-071DBL

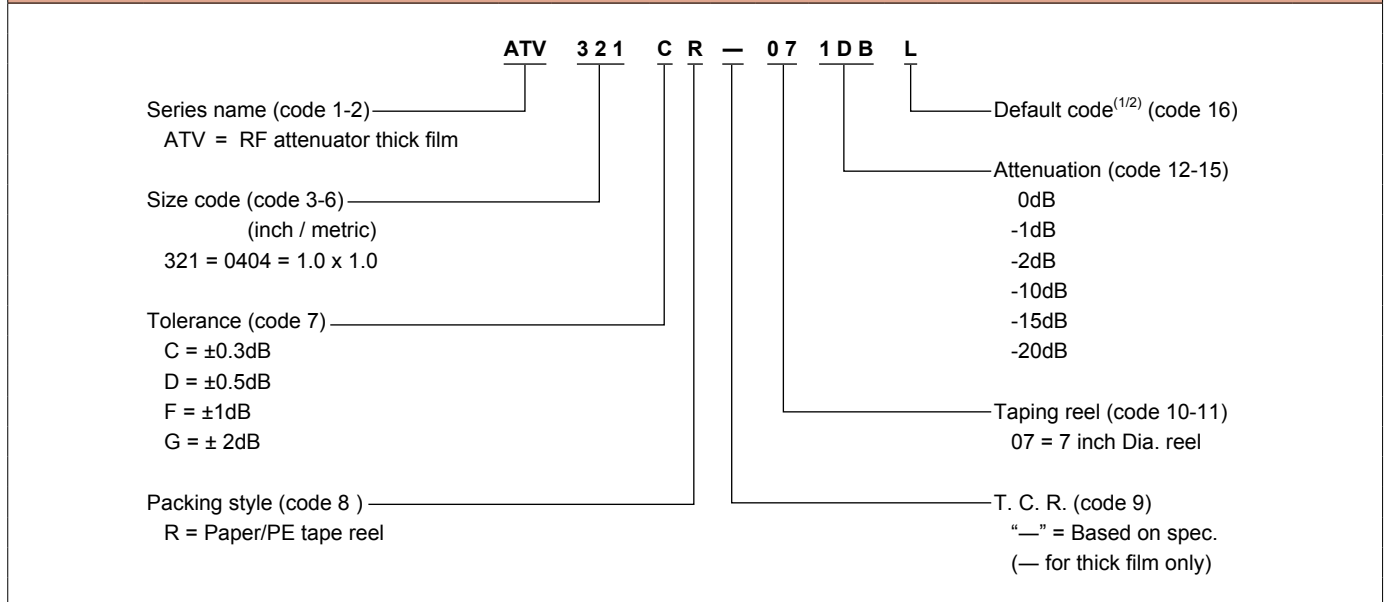

Note: 1. All of our RSMD products are RoHS compliant. "LFP" of the internal 2D reel label mentions "Lead Free Process"
2. Letter L is system default code for ordering only

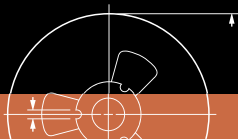

Chip Resistors Selection Charts

ATV - RF attenuator chip resistors, 0404

Phycomp worldwide - Traditional type	
Packing	paper tape
Quantity 10 000	2350 703 11...L
Remark	For last three digits, see following table "Attenuation codes"

Note: L = Default code

Phycomp CTC ordering code - Traditional type - North America	
Packing	paper tape
Quantity 10 000	9CV3218AXXXX-PF3
Remark	For last 9th to 13th digits, see following table "Attenuation codes"

Attenuation codes			
Standard			
Value (dB)	Tolerance (dB)	Phycomp worldwide code (12NC)	Phycomp North America code (NA code)
1	±0.3	012	01DBC
2	±0.3	022	02DBC
3	±0.3	032	03DBC
4	±0.3	042	04DBC
5	±0.3	052	05DBC
6	±0.5	063	06DBD
7	±0.5	073	07DBD
8	±0.5	083	08DBD
9	±0.5	093	09DBD
10	±0.5	103	10DBD
15	±1.0	154	15DBF
20	±2.0	205	20DBG



Yageo Part Number	Resistor pieces	Resistor values	Description	Size	Tolerance	Max. power	Resistance range
Thick film chip resistors							
RC0201FR-SNE96L	100	300	RC0201, $\pm 1\%$, E24&E96, RoHS compliant + Jumper	0201	F	1/20W	0R,1R-10M
RC0402FR-SNE96L	100	300	RC0402, $\pm 1\%$, E24&E96, RoHS compliant + Jumper	0402	F	1/16W	0R,1R-10M
RC0603FR-SNE96L	50	300	RC0603, $\pm 1\%$, E24&E96, RoHS compliant + Jumper	0603	F	1/10W	0R,1R-10M
RC0805FR-SNE96L	50	300	RC0805, $\pm 1\%$, E24&E96, RoHS compliant + Jumper	0805	F	1/8W	0R,1R-10M
RC1206FR-SNE96L	50	300	RC1206, $\pm 1\%$, E24&E96, RoHS compliant + Jumper	1206	F	1/4W	0R,1R-10M
RC0100-R-SKE24L	100	80	RC0100, $\pm 1\%$ & $\pm 5\%$, E24 & E96, RoHS compliant, + Jumper	0100	F/J	1/32W	0R, 1R-3M32
RC0201-R-SKE24L	100	120	RC0201, $\pm 1\%$ & $\pm 5\%$, E24 & E96, RoHS compliant, + Jumper	0201	F/J	1/20W	0R, 1R-10M
RC0201FR-SKE96L	100	200	RC0201, $\pm 1\%$, E96, RoHS compliant	0201	F	1/20W	1R-10M
RC0402JR-SKE24L	100	120	RC0402, $\pm 5\%$, E24, RoHS compliant, + Jumper	0402	J	1/16W	0R, 1R-22M
RC0402FR-SKE96L	100	200	RC0402, $\pm 1\%$, E96, RoHS compliant	0402	F	1/16W	1R-10M
RC0603JR-SKE24L	50	120	RC0603, $\pm 5\%$, E24, RoHS compliant, + Jumper	0603	J	1/10W	0R, 1R-22M
RC0603FR-SKE96L	50	200	RC0603, $\pm 1\%$, E96, RoHS compliant	0603	F	1/10W	1R-10M
RC0805JR-SKE24L	50	120	RC0805, $\pm 5\%$, E24, RoHS compliant, + Jumper	0805	J	1/8W	0R, 1R-22M
RC0805FR-SKE96L	50	200	RC0805, $\pm 1\%$, E96, RoHS compliant	0805	F	1/8W	1R-10M
RC1206JR-SKE24L	50	120	RC1206, $\pm 5\%$, E24, RoHS compliant, + Jumper	1206	J	1/4W	0R, 1R-22M
RC1206FR-SKE96L	50	200	RC1206, $\pm 1\%$, E96, RoHS compliant	1206	F	1/4W	1R-10M
RC0000-R-SK001L	50 - 100	570	RC0201-RC1206, $\pm 1\%$ & $\pm 5\%$, RoHS compliant, + Jumper	0201-1206	F/J	---	0R, 10R-1M
Thick film array chip resistors (convex)							
YC12X-JR-SK001L	100	75	YC124/122, $\pm 5\%$, RoHS compliant, + Jumper	0402x2 0402x4	J	1/16W	0R, 1R-1M
Engineering design kit for current sensing application							
CS0201-R-SB001L	10	60	PA/PE/RL/PT, $\pm 5\%$, $\pm 1\%$, E24 & E96, RoHS compliant	0201~2512	F/J	---	1m-820m
CS0402-R-SK001L	30	160	RL0402-RL2512, $\pm 1\%$ & $\pm 5\%$, RoHS compliant	0402 - 2512	F/J	---	100m - 910m
ME0201-R-SB001L	15	60	Metal current sensor, PA/PE/PS/PU,E24 & E96, RoHS compliant	0201-2512	F	---	0.2m-150m
Engineering design kit for general purpose							
RC0402-R-SK001L	50 - 100	472	Chip resistor / MLCC	0402 - 1206	---	---	---
Engineering design book for thin film chip resistor							
RT0402-R-SB001L	10	60	RT0402-RT1206, $\pm 0.1\%$, RoHS compliant	0402 - 1206	B	---	10R-1M
RT0201-R-SB001L	10	60	RT0201-RT0402, $\pm 0.1\%$, RoHS compliant	0201 - 0402	B	---	10R-120K
AT0402-R-SB001L	10	60	AT0402~AT1206, $\pm 0.1\sim \pm 1\%$, E24 & E96, RoHS compliant	0402~1206	B/D/F	1/4W	10R~1M
Engineering design book for automotive application							
AC0402-R-SB001L	10	60	AC0402-AC1206, $\pm 1\%$, RoHS compliant	0402 - 1206	F	---	10R-1M
AC0201-R-SB001L	10	60	Automotive Grade: AC/AF/AT/PE/PA/RL/PT, $\pm 0.1\sim \pm 5\%$, E24 & E96, RoHS compliant, +Jumper	0201~2512	B/D/F/J	---	---
Engineering design book for Thick film chip resistors							
RC0805-R-SBE24L	10	60	RC0805, $\pm 1\%$ & $\pm 5\%$, RoHS compliant, High power	0805	F	1/4W	1R-1M
RC1206-R-SBE24L	10	60	RC1206, $\pm 1\%$ & $\pm 5\%$, RoHS compliant, High power	1206	F	1/2W	1R-1M
RC0201-R-SB001P	10	60	Total Lead Free: RC0201~1206, $\pm 1\%$, + Jumper	0201~1206	F	---	0R, 1R-10M

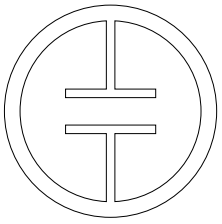

SURFACE MOUNT MLCC

Specification overview					
Description	TC code	Series	Capacitance range	Voltage range	Size
Discrete	NPO	General purpose	0.47 pF to 100 nF	10 V to 50 V	01005, 0201, 0402, 0603, 0805, 1206, 1210, 1812
		Medium and High voltage	10 pF to 22 nF	100 V to 3000 V	0201, 0402, 0603, 0805, 1206, 1210, 1808, 1812
		High frequency	0.2 pF to 100 pF	16V to 250 V	01005, 0201, 0402, 0603, 0805
	X7R	General purpose & High capacitance	100 pF to 47 μ F	6.3 V to 50 V	01005, 0201, 0402, 0603, 0805, 1206, 1210, 1812, 2220
		Medium and High voltage	100 pF to 2.2 μ F	100 V to 3000 V	0402, 0603, 0805, 1206, 1210, 1812
		Low inductance	10 nF to 220 nF	10 V to 50 V	0204, 0306, 0508, 0612
	X5R	General purpose & High capacitance	100 pF to 220 μ F	6.3 V to 50 V	01005, 0201, 0402, 0603, 0805, 1206, 1210
Y5V	General purpose & High capacitance	10 nF to 47 μ F	6.3 V to 50 V	0402, 0603, 0805, 1206, 1210	
Automotive grade products	NPO	Automotive grade	10 pF to 10 nF	50 V to 630 V	0402, 0603, 0805, 1206, 1210
	X8R	Automotive grade	22 nF to 100 nF	16 V to 50 V	0805
	X8G	Automotive grade	1 nF to 10 nF	25 V to 100 V	0805
	X7R	Automotive grade	100 pF to 2.2 μ F	16 V to 630 V	0201, 0402, 0603, 0805, 1206, 1210
	X7R	Soft-termination	1nF to 4.7 μ F	16V to 250V	0603, 0805, 1206, 1210
	NPO	High frequency	0.2pF to 100pF	50V	0603
Soft-termination Series	NPO	Soft-termination series	0.47 pF to 22 nF	100 V to 3 KV	0402, 0603, 0805, 1206, 1210, 1808, 1812
	X7R	Soft-termination series	100 pF to 10 μ F	16 V to 3 KV	0402, 0603, 0805, 1206, 1210, 1808, 1812
C-Arrays	NPO	4C arrays	10 pF to 470 pF	50 V	0508, 0612
	X7R	4C arrays	180 pF to 100 nF	16 V to 50 V	0508, 0612

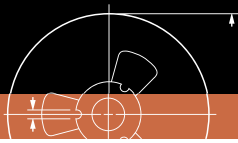

MLCC General Information

Ordering information - Global part number

Global part number

Ordering example: CC0201KRX7R8BB102

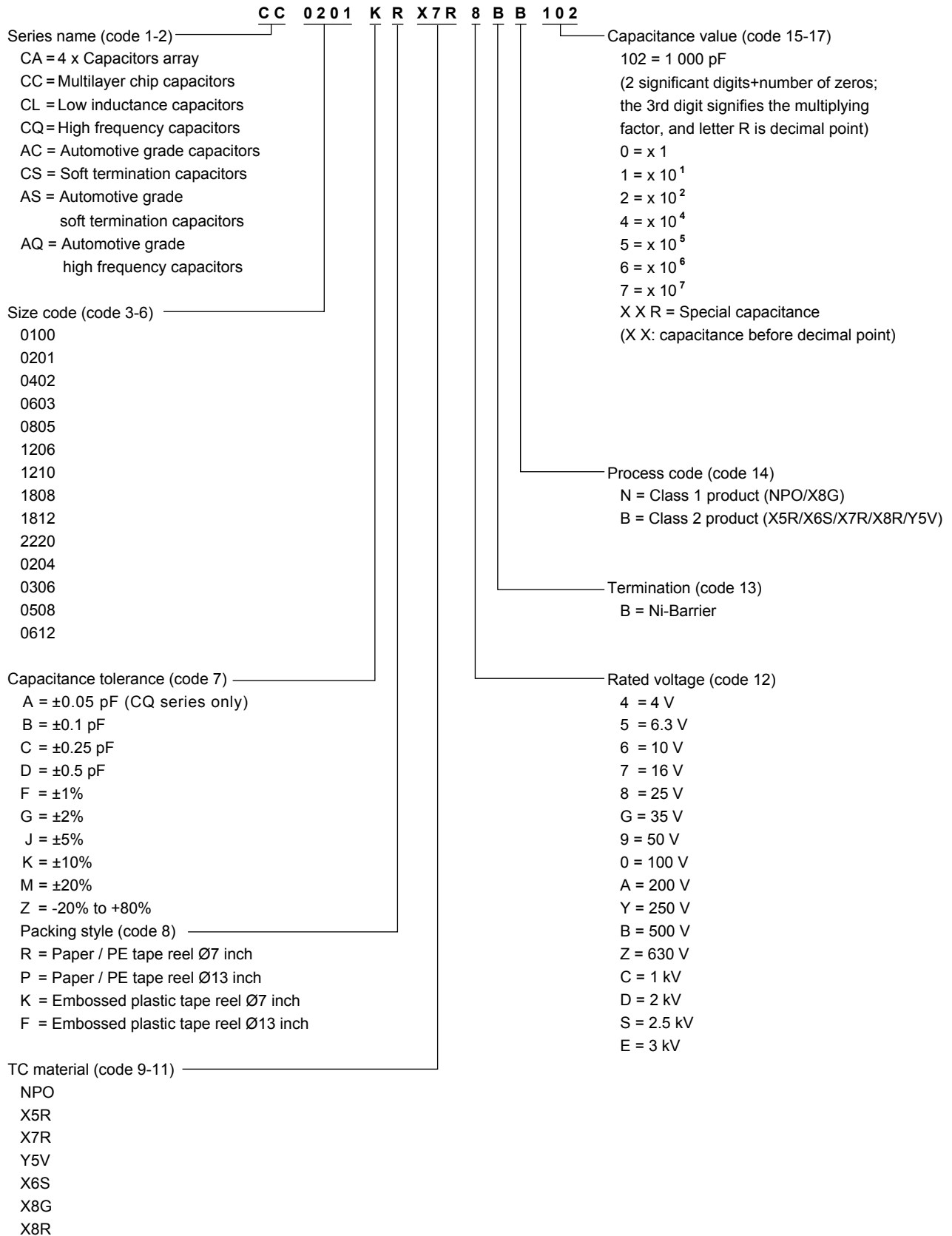

Global part number

Ordering example: CCxxxxKRX5RxBBxxx (for Low profile)

<p>Series name (code 1-2) ——— CC</p> <p>CC = Multilayer chip capacitors</p> <p>Number of cap (code 3) ——— 1</p> <p>4 = 4 cap 2 = 2 cap 1 = Single</p> <p>Size code (code 4-5) ——— 05</p> <p>01 = 0201 02 = 0402 03 = 0603 05 = 0805 06 = 1206, 0306 08 = 1808, 0508 10 = 1210 12 = 1812, 0612</p> <p>Thickness (code 6) ——— 9</p> <p>3 = 0.3 mm 4 = 0.45 mm 5 = 0.5 mm 6 = 0.6 mm 8 = 0.8 mm 9 = 0.85 mm A = 1.0 mm B = 1.25 mm C = 1.6 mm D = 2.0 mm E = 2.5 mm F = 1.7 mm M = 1.15 mm N = 1.35 mm Q = 1.5 mm R = 1.8 mm</p> <p>Capacitance tolerance (code 7) ——— K</p> <p>B = ±0.1 pF C = ±0.25 pF D = ±0.5 pF F = ±1% G = ±2% J = ±5% K = ±10% M = ±20% Z = -20% to +80%</p> <p>Packing style (code 8) ——— R</p> <p>R = Paper / PE tape reel Ø7 inch P = Paper / PE tape reel Ø13 inch K = Embossed plastic tape reel Ø7 inch F = Embossed plastic tape reel Ø13 inch</p>	<p>X7R</p> <p>8</p> <p>B B</p> <p>102</p> <p>Capacitance value (code 15-17)</p> <p>102 = 1 000 pF (2 significant digits+number of zeros; the 3rd digit signifies the multiplying factor, and letter R is decimal point)</p> <p>0 = x 1 1 = x 10¹ 2 = x 10² 3 = x 10³ 4 = x 10⁴ 5 = x 10⁵ 6 = x 10⁶ 7 = x 10⁷ X X R = Special capacitance (X X: capacitance before decimal point)</p> <p>Process code (code 14)</p> <p>N = Class 1 product B = Class 2 product</p> <p>Termination (code 13)</p> <p>B = Ni-Barrier</p> <p>Rated voltage (code 12)</p> <p>5 = 6.3 V 6 = 10 V 7 = 16 V 8 = 25 V 9 = 50 V 0 = 100 V A = 200 V B = 500 V C = 1 kV D = 2 kV E = 3 kV G = 35 V Y = 250 V Z = 630 V</p> <p>TC material (code 9-11)</p> <p>X5R X7R</p>
---	--



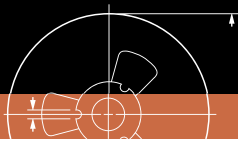

MLCC General Information

Thickness classes and packing quantities for all series

Thickness classes and packing quantities										
Description	Size code	Thickness classification (mm)	Tape width	Quantity per reel				Quantity per bulk case		
				180 mm / 7"		330 mm / 13"				
				Paper	Blister	Paper	Blister			
Discrete capacitors	01005	0.2 ±0.02	8 mm	20000	---	---	---	---		
	0201	0.3 ±0.03 / ±0.05		15000	---	50000	---	---		
	0402	0.5 ±0.05 / ±0.15 / ±0.20		10000	---	50000	---	50000		
	0603	0.8 ±0.1 / ±0.2		4000	---	15000	---	15000		
	0805	0.6 ±0.1 0.85 / 1.0 ±0.1 1.25 ±0.2		4000	---	20000	---	10000		
				4000	---	15000	---	8000		
				---	3000	---	10000	5000		
	1206	0.6 ±0.1 0.85 ±0.1 1.00 / 1.15 ±0.1 1.25 ±0.2 1.6 ±0.15 1.6 ±0.2 / ±0.3		4000	---	20000	---	---		
				4000	---	15000	---	---		
				---	3000	---	10000	---		
				---	3000	---	10000	---		
				---	2500	---	8000	---		
				---	2000	---	8000	---		
	1210	0.6 / 0.7 ±0.1 0.85 ±0.1 1.0 ±0.15 1.15 ±0.1 1.15 ±0.15 1.25 ±0.2 1.5 ±0.1 1.6 / 1.9 ±0.2 2.0 ±0.2 2.5 ±0.2 / ±0.3		---	4000	---	15000	---		
				---	4000	---	10000	---		
				---	3000	---	10000	---		
				---	3000	---	10000	---		
				---	3000	---	10000	---		
				---	3000	---	10000	---		
				---	2000	---	8000	---		
				---	2000	---	5000	---		
				---	2000 / 1000	---	---	---		
				---	1000 / 500	---	---	---		
	1808	1.15 ±0.15 1.25 ±0.2 1.35 ±0.15 1.5 ±0.1 1.6 ±0.2 2.0 ±0.2		---	3000	---	---	---		
				---	3000	---	---	---		
				---	2000	---	---	---		
				---	2000	---	---	---		
				---	2000	---	8000	---		
				---	2000	---	---	---		
				1812	0.6 / 0.85 ±0.1 1.15 ±0.1 1.15 ±0.15 1.25 ±0.2 1.35 ±0.15 1.5 ±0.1 1.6 ±0.2 2.0 ±0.2	---	2000	---	---	---
						---	1000	---	---	---
						---	1000	---	---	---
						---	1000	---	8000	---
	---	1000				---	---	---		
	---	1000				---	---	---		
	---	1000				---	---	---		
	---	1000				---	---	---		
	2220	0.85 ±0.1 1.15 ±0.1		---	1500	---	---	---		
				---	1500	---	---	---		
	Low inductance	0204		0.3 ±0.1	8 mm	10000	---	---	---	
0306		0.5 ±0.1	4000	---		15000	---			
0508		0.85 ±0.1	4000	---		15000	---			
0612		0.85 ±0.1	4000	---		15000	---			
Arrays	0508	0.6 ±0.1	8 mm	4000	---	20000	---			
	0612	0.8 ±0.1		4000	---	15000	---			





Features

- Ultra-stable on capacitance
- Tight tolerance available
- High reliability
- Low ESR
- Good frequency performance
- No aging of capacitance

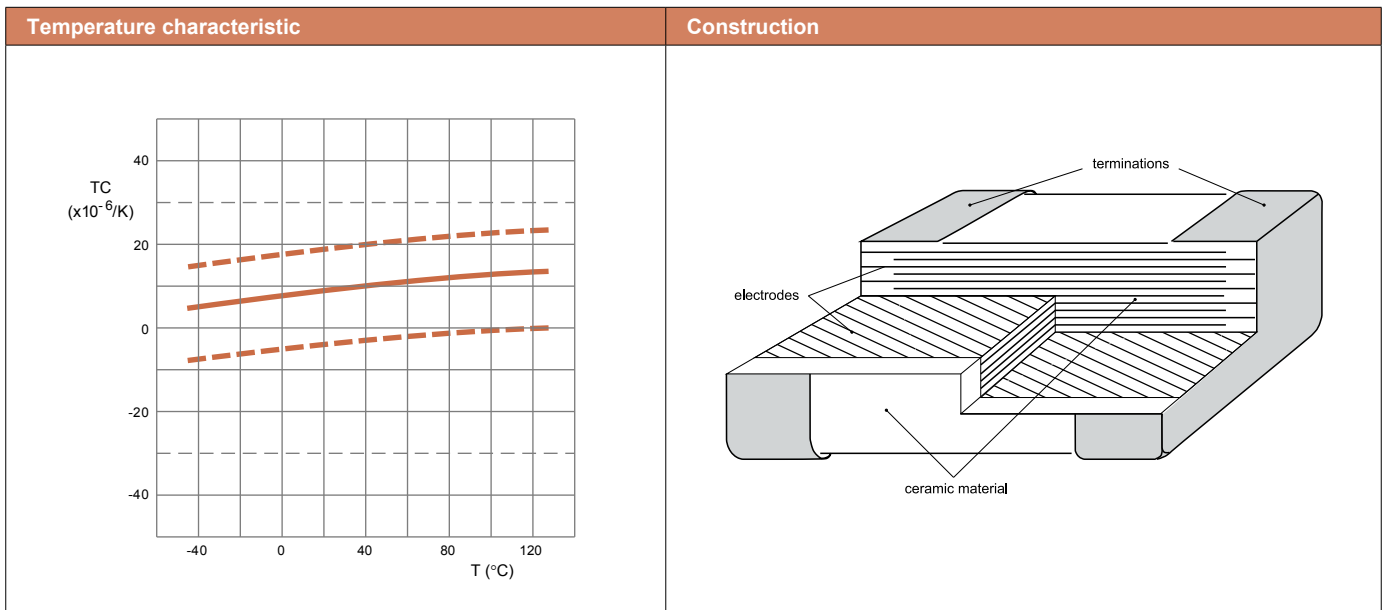

Case dimensions							
Discrete capacitors - General purpose							
	Case size designation		Dimensions in mm				
	Inch-based	Metric	L ₁	W	L ₂ / L ₃ min	L ₂ / L ₃ max	L ₄ min
	01005	0402M	0.4 ±0.02	0.2 ±0.02	0.07	0.14	0.14
0201	0603M	0.6 ±0.03	0.3 ±0.03	0.10	0.20	0.20	
0402	1005M	1.0 ±0.05	0.5 ±0.05	0.15	0.35	0.40	
0603	1608M	1.6 ±0.10	0.8 ±0.10	0.20	0.60	0.40	
0805	2012M	2.0 ±0.10 ⁽¹⁾	1.25 ±0.10 ⁽¹⁾	0.25	0.75	0.55	
		2.0 ±0.20 ⁽²⁾	1.25 ±0.20 ⁽²⁾	0.25	0.75	0.55	
1206	3216M	3.2 ±0.15 ⁽¹⁾	1.6 ±0.15 ⁽¹⁾	0.25	0.75	1.40	
		3.2 ±0.30 ⁽²⁾	1.6 ±0.20 ⁽²⁾	0.25	0.75	1.40	
1210	3225M	3.2 ±0.20 ⁽¹⁾	2.5 ±0.20 ⁽¹⁾	0.25	0.75	1.40	
		3.2 ±0.40 ⁽²⁾	2.5 ±0.30 ⁽²⁾	0.25	0.75	1.40	
1812	4532M	4.5 ±0.20 ⁽¹⁾	3.2 ±0.20 ⁽¹⁾	0.25	0.75	2.20	
		4.5 ±0.40 ⁽²⁾	3.2 ±0.40 ⁽²⁾	0.25	0.75	2.20	

Note: 1. Dimension for size 0805 to 1812, C ≤ 1 nF
 2. Dimension for size 0805 to 1812, C > 1 nF

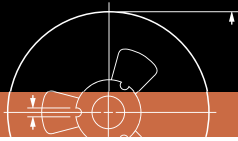

MLCC Selection Charts

NPO - General purpose 10 to 50V, 01005 to 0603

NPO												
General purpose												
Capacitance	01005			0201			0402			0603		
	10 V	16 V	25 V	16 V	25 V	50 V	16 V	25 V	50 V	16 V	25 V	50 V
0.22 pF				0.3 ±0.03	0.3 ±0.03	0.3 ±0.03						
0.47 pF				0.3 ±0.03	0.3 ±0.03	0.3 ±0.03	0.5 ±0.05	0.5 ±0.05	0.5 ±0.05	0.8 ±0.1	0.8 ±0.1	0.8 ±0.1
0.5 pF	0.2 ±0.02	0.2 ±0.02	0.2 ±0.02									
0.56 pF				0.3 ±0.03	0.3 ±0.03	0.3 ±0.03	0.5 ±0.05	0.5 ±0.05	0.5 ±0.05	0.8 ±0.1	0.8 ±0.1	0.8 ±0.1
0.6 pF	0.2 ±0.02	0.2 ±0.02	0.2 ±0.02									
0.68 pF				0.3 ±0.03	0.3 ±0.03	0.3 ±0.03	0.5 ±0.05	0.5 ±0.05	0.5 ±0.05	0.8 ±0.1	0.8 ±0.1	0.8 ±0.1
0.7 pF	0.2 ±0.02	0.2 ±0.02	0.2 ±0.02									
0.8 pF	0.2 ±0.02	0.2 ±0.02	0.2 ±0.02									
0.82 pF				0.3 ±0.03	0.3 ±0.03	0.3 ±0.03	0.5 ±0.05	0.5 ±0.05	0.5 ±0.05	0.8 ±0.1	0.8 ±0.1	0.8 ±0.1
0.9 pF	0.2 ±0.02	0.2 ±0.02	0.2 ±0.02									
1 pF												
1.2 pF												
1.5 pF												
1.8 pF												
2.2 pF												
2.7 pF												
3.3 pF												
3.9 pF												
4.7 pF												
5.6 pF												
6.8 pF												
8.2 pF												
10 pF	0.2 ±0.02	0.2 ±0.02	0.2 ±0.02	0.3 ±0.03	0.3 ±0.03	0.3 ±0.03						
12 pF												
15 pF												
18 pF												
22 pF												
27 pF												
33 pF							0.5 ±0.05	0.5 ±0.05	0.5 ±0.05	0.8 ±0.1	0.8 ±0.1	0.8 ±0.1
39 pF												
47 pF												
56 pF												
68 pF												
82 pF												
100 pF												
120 pF												
150 pF												
180 pF												
220 pF												
270 pF												
330 pF												
390 pF												
470 pF												
560 pF												
680 pF												
820 pF												
1000 pF												
Tape width	8 mm											

Note: Values in shaded cells indicate thickness class (unit: mm)



MLCC Selection Charts

NPO - General purpose 16 to 50V, 01005 to 1812

NPO												
General purpose												
Capacitance	01005	0201			0402			0603				
	16 V	16 V	25 V	50 V	16 V	25 V	50 V	16 V	25 V	50 V		
1.2 nF								0.8 ±0.1	0.8 ±0.1	0.8 ±0.1		
1.5 nF												
1.8 nF												
2.2 nF												
2.7 nF												
3.3 nF												
3.9 nF												
4.7 nF												
5.6 nF												
6.8 nF												
8.2 nF												
10 nF												
Tape width	8 mm											

Note: Values in shaded cells indicate thickness class (unit: mm)

NPO										
General purpose										
Capacitance	0805			1206			1210		1812	
	16 V	25 V	50 V	16 V	25 V	50 V	25 V	50 V	50 V	
0.47 pF										
0.56 pF										
0.68 pF										
0.82 pF										
1 pF										
1.2 pF										
1.5 pF										
1.8 pF										
2.2 pF										
2.7 pF										
3.3 pF										
3.9 pF										
4.7 pF										
5.6 pF										
6.8 pF										
8.2 pF										
10 pF										
12 pF										
15 pF										
18 pF										
22 pF	0.6 ±0.1	0.6 ±0.1	0.6 ±0.1	0.6 ±0.1	0.6 ±0.1	0.6 ±0.1				
27 pF										
33 pF										
39 pF										
47 pF										
56 pF										
68 pF										
82 pF										
100 pF										
120 pF										
150 pF										
180 pF										
220 pF							1.25 ±0.2	1.25 ±0.2	1.25 ±0.2	
270 pF										
330 pF										
390 pF										
470 pF										
560 pF										
680 pF										
820 pF										
1000 pF										
Tape width	8 mm									

Note: Values in shaded cells indicate thickness class (unit: mm)



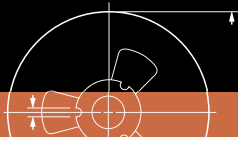

MLCC Selection Charts

NPO - General purpose 10 to 50V, 0805 to 1812

NPO									
General purpose									
Capacitance	0805			1206			1210		1812
	16 V	25 V	50 V	16 V	25 V	50 V	25 V	50 V	50 V
1.2 nF									
1.5 nF	0.85 ±0.1	0.85 ±0.1	0.85 ±0.1						
1.8 nF				0.6 ±0.1	0.6 ±0.1	0.6 ±0.1			
2.2 nF									
2.7 nF									
3.3 nF									
3.9 nF									
4.7 nF	1.25 ±0.2	1.25 ±0.2	1.25 ±0.2	0.85 ±0.1	0.85 ±0.1	0.85 ±0.1	1.25 ±0.2	1.25 ±0.2	1.25 ±0.2
5.6 nF									
6.8 nF									
8.2 nF				1.25 ±0.2	1.25 ±0.2	1.25 ±0.2			
10 nF									
12 nF									
15 nF									
18 nF				0.85 ±0.1	0.85 ±0.1	0.85 ±0.1			
22 nF							1.6 ±0.2	1.6 ±0.2	
33 nF									
39 nF									
47 nF				1.25 ±0.2	1.25 ±0.2	1.25 ±0.2			
56 nF									
68 nF									
82 nF				1.6 ±0.2	1.6 ±0.2	1.6 ±0.2			
100 nF									
Tape width	8 mm								

Note: Values in shaded cells indicate thickness class (unit: mm)





Features

- Capable of operating at high voltage levels
- For high frequency snubber
- Decoupling / smoothing function

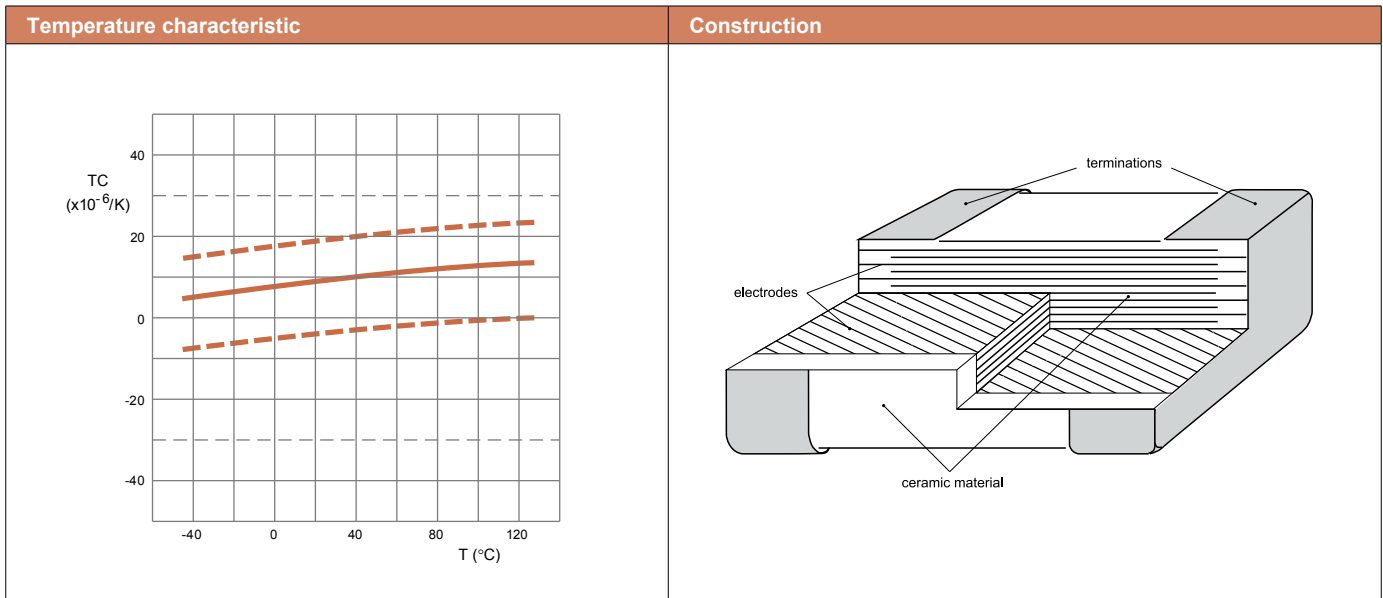

Dimensions							
Discrete capacitors - Medium and High voltage							
	Case size designation		Dimensions in mm				
	Inch-based	Metric	L ₁	W	L ₂ / L ₃ min	L ₂ / L ₃ max	L ₄ min
	0201	0603M	0.6 ±0.03	0.3 ±0.03	0.10	0.20	0.20
	0402	1005M	1.0 ±0.05	0.5 ±0.05	0.15	0.35	0.40
	0603	1608M	1.6 ±0.10	0.8 ±0.10	0.20	0.60	0.40
	0805	2012M	2.0 ±0.20	1.25 ±0.20	0.25	0.75	0.55
	1206	3216M	3.2 ±0.30	1.6 ±0.20	0.25	0.75	1.40
	1210	3225M	3.2 ±0.40	2.5 ±0.30	0.25	0.75	1.40
	1808	4520M	4.5 ±0.40	2.0 ±0.30	0.25	0.75	2.20
	1812	4532M	4.5 ±0.40	3.2 ±0.30	0.25	0.75	2.20

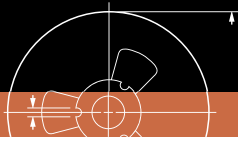

MLCC Selection Charts

NPO - Medium voltage, 0201 to 0805

NPO								
Medium voltage								
Capacitance	0201	0402	0603		0805			
	100V	100 V	100 V	250 V	100 V	250 V	500 V	630 V
0.22 pF	0.3 ±0.03	0.5 ±0.05	0.8 ±0.1	0.8 ±0.1	0.6 ±0.1	0.6 ±0.1	0.6 ±0.1	0.6 ±0.1
0.47 pF								
0.56 pF								
0.68 pF								
0.82 pF								
1 pF								
1.2 pF								
1.5 pF								
1.8 pF								
2.2 pF								
2.7 pF								
3.3 pF								
3.9 pF								
4.7 pF								
5.6 pF								
6.8 pF								
8.2 pF								
10 pF								
12 pF								
15 pF								
18 pF								
22 pF								
27 pF								
33 pF								
39 pF								
47 pF								
56 pF								
68 pF								
82 pF								
100 pF								
120 pF								
150 pF								
180 pF								
220 pF								
270 pF								
330 pF								
390 pF								
470 pF								
560 pF								
680 pF								
820 pF								
1000 pF								
1.2 nF								
1.5 nF								
1.8 nF								
2.2 nF								
2.7 nF								
3.3 nF								
3.9 nF								
4.7 nF								
5.6 nF								
6.8 nF								
8.2 nF								
10 nF								

Tape width 8 mm

Note: Values in shaded cells indicate thickness class (unit: mm)



MLCC Selection Charts

NPO - Medium voltage, 1206 to 1812

NPO												
Medium voltage												
Capacitance	1206				1210				1812			
	100 V	250 V	500 V	630 V	100 V	250 V	500 V	630 V	100 V	250 V	500 V	630 V
1 pF												
1.2 pF												
1.5 pF												
1.8 pF												
2.2 pF												
2.7 pF												
3.3 pF												
3.9 pF												
4.7 pF												
5.6 pF												
6.8 pF												
8.2 pF												
10 pF												
12 pF												
15 pF												
18 pF												
22 pF												
27 pF												
33 pF												
39 pF												
47 pF												
56 pF												
68 pF												
82 pF												
100 pF												
120 pF												
150 pF												
180 pF												
220 pF												
270 pF												
330 pF												
390 pF												
470 pF												
560 pF												
680 pF												
820 pF												
1000 pF												
1.2 nF												
1.5 nF												
1.8 nF												
2.2 nF												
2.7 nF												
3.3 nF												
3.9 nF												
4.7 nF												
5.6 nF												
6.8 nF												
8.2 nF												
10 nF												
22 nF												
Tape width	8 mm											

Note: Values in shaded cells indicate thickness class (unit: mm)



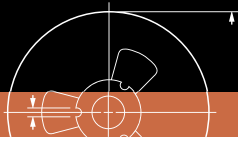

MLCC Selection Charts

NPO - High voltage, 0805 to 1812

NPO								
High voltage								
Capacitance	0805	1206			1210			
	1000 V	1000 V	2000 V	3000V	1000 V	2000 V		
10 pF	0.85 ±0.1	1.25 ±0.2	1.25 ±0.2	1.25 ±0.2				
12 pF								
15 pF								
18 pF								
22 pF								
27 pF								
33 pF								
39 pF								
47 pF								
56 pF								
68 pF								
82 pF								
100 pF		1.25 ±0.2						
120 pF								
150 pF								
180 pF								
220 pF								
270 pF								
330 pF								
390 pF								
470 pF								
560 pF								
680 pF								
820 pF								
1000 pF								
Tape width	8 mm							

Note: Values in shaded cells indicate thickness class (unit: mm)

NPO						
High voltage						
Capacitance	1808			1812		
	1000 V	2000 V	3000 V	1000 V	2000 V	3000 V
10 pF			1.6 ±0.2	1.25 ±0.2	1.25 ±0.2	1.25 ±0.2
12 pF						
15 pF						
18 pF						
22 pF						
27 pF						
33 pF						
39 pF						
47 pF						
56 pF						
68 pF						
82 pF						
100 pF	1.25 ±0.2	1.25 ±0.2				
120 pF						
150 pF						
180 pF						
220 pF						
270 pF						
330 pF						
390 pF						
470 pF						
560 pF						
680 pF						
820 pF						
1000 pF	2.0 ±0.2					
1.2 nF						
1.5 nF						
Tape width	12 mm					

Note: Values in shaded cells indicate thickness class (unit: mm)





Features

- Lowest ESR in high frequency
- Ultra small
- Noise filtering

ESR characteristic

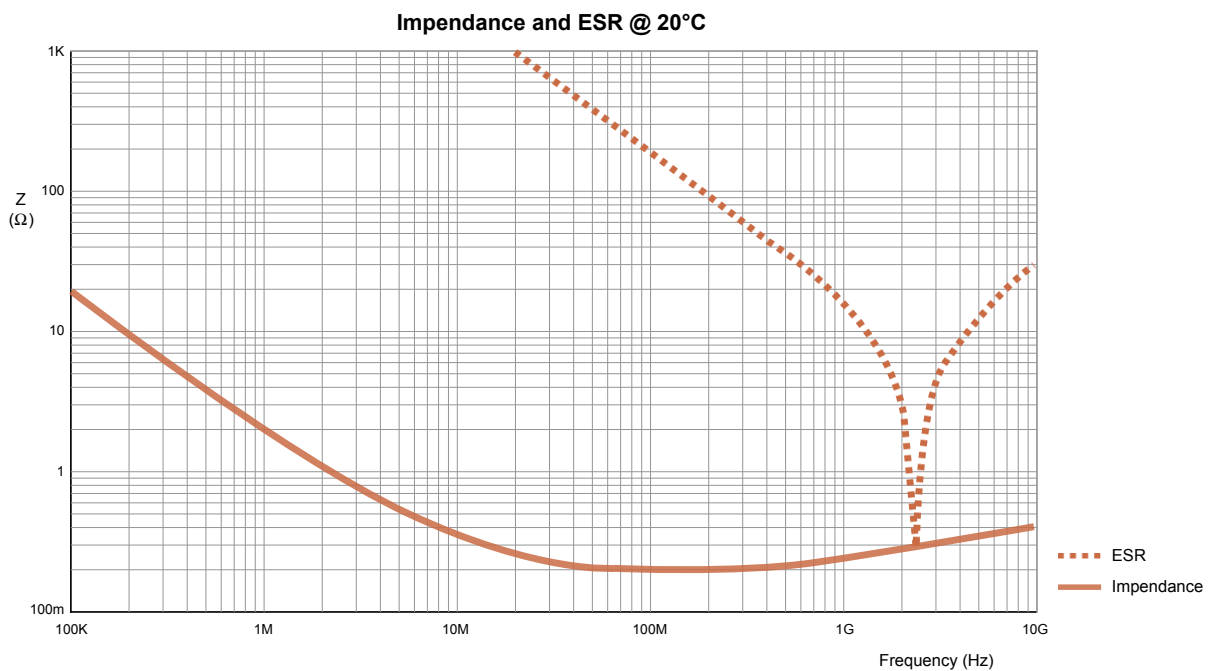

Construction

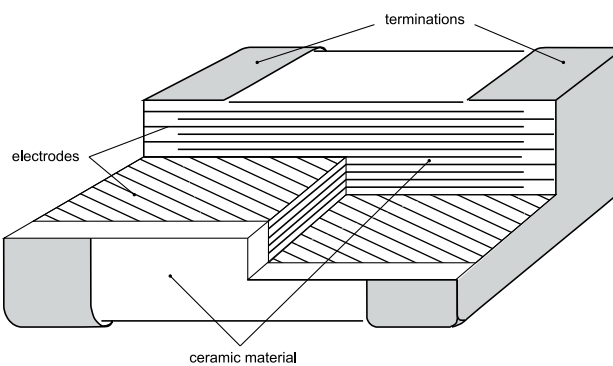



MLCC Selection Charts

NPO - High frequency, 01005 to 0805

Case dimensions							
Discrete capacitors - High Frequency							
	Case size designation		Dimensions in mm				
	Inch-based	Metric	L ₁	W	L ₂ / L ₃ min	L ₂ / L ₃ max	L ₄ min
	01005	0402M	0.4 ±0.02	0.2 ±0.02	0.07	0.14	0.13
	0201	0603M	0.6 ±0.03	0.3 ±0.03	0.10	0.20	0.20
	0402	1005M	1.0 ±0.05	0.5 ±0.05	0.15	0.35	0.40
	0603	1608M	1.6 ±0.10	0.8 ±0.10	0.20	0.60	0.40
	0805	2012M	2.0 ±0.10	1.25 ±0.10	0.25	0.75	0.55

NPO													
High frequency													
Capacitance	01005	0201		0402				0603			0805		
	16 V	25 V	50 V	25 V	50 V	100 V	250 V	50 V	100 V	250 V	50 V	100 V	250 V
0.1 pF													
0.2 pF													
0.3 pF													
0.4 pF													
0.5 pF													
0.6 pF													
0.7 pF													
0.8 pF													
0.9 pF													
1 pF													
1.2 pF													
1.5 pF	0.2 ±0.02	0.3 ±0.03	0.3 ±0.03										
1.8 pF													
2.2 pF													
2.7 pF													
3.3 pF													
3.9 pF													
4.7 pF				0.5 ±0.05	0.5 ±0.05	0.5 ±0.05	0.5 ±0.05	0.8 ±0.1	0.8 ±0.1	0.8 ±0.1	0.6 ±0.1	0.6 ±0.1	0.6 ±0.1
5.6 pF													
6.8 pF													
8.2 pF													
10 pF													
12 pF													
15 pF													
18 pF													
22 pF													
27 pF													
33 pF													
39 pF													
47 pF													
56 pF													
68 pF													
82 pF													
100 pF													
Tape width	8 mm												

Note: Values in shaded cells indicate thickness class (unit: mm)





Features

- Semi-stable on capacitance and high K
- High volumetric efficiency
- Highly reliable in high temperature application
- High insulation resistance

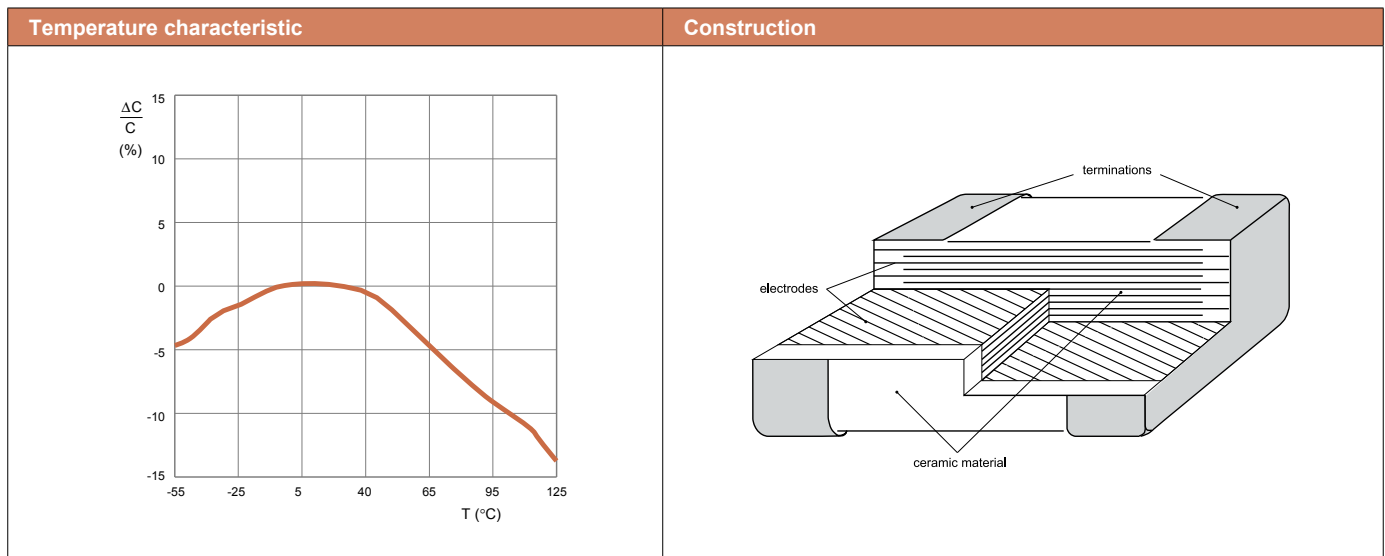

Case dimensions							
Discrete capacitors - General purpose & High capacitance							
	Case size designation		Dimensions in mm				
	Inch-based	Metric	L ₁	W	L ₂ / L ₃ min	L ₂ / L ₃ max	L ₄ min
	01005	0402M	0.4 ±0.02	0.2 ±0.02	0.07	0.14	0.14
0201	0603M	0.6 ±0.03	0.3 ±0.03	0.10	0.20	0.20	
		0.6 ±0.05	0.3 ±0.05	0.10	0.20	0.20	
0402	1005M	1.0 ±0.05 ⁽¹⁾	0.5 ±0.05 ⁽¹⁾	0.15	0.35	0.40	
0603	1608M	1.6 ±0.10 ⁽¹⁾	0.8 ±0.10 ⁽¹⁾	0.20	0.60	0.40	
		1.6 ±0.15 ⁽²⁾	0.8 ±0.15 ⁽²⁾	0.20	0.60	0.40	
0805	2012M	2.0 ±0.10 ⁽¹⁾	1.25 ±0.10 ⁽¹⁾	0.25	0.75	0.55	
		2.0 ±0.20 ⁽²⁾	1.25 ±0.20 ⁽²⁾	0.25	0.75	0.55	
1206	3216M	3.2 ±0.15 ⁽¹⁾	1.6 ±0.15 ⁽¹⁾	0.25	0.75	1.40	
		3.2 ±0.30 ⁽²⁾	1.6 ±0.20 ⁽²⁾	0.25	0.75	1.40	
1210	3225M	3.2 ±0.20 ⁽¹⁾	2.5 ±0.20 ⁽¹⁾	0.25	0.75	1.40	
		3.2 ±0.40 ⁽²⁾	2.5 ±0.30 ⁽²⁾	0.25	0.75	1.40	
1808	4520M	4.5 ±0.40	2.0 ±0.30	0.25	0.75	2.20	
1812	4532M	4.5 ±0.20 ⁽¹⁾	3.2 ±0.20 ⁽¹⁾	0.25	0.75	2.20	
		4.5 ±0.40 ⁽²⁾	3.2 ±0.40 ⁽²⁾	0.25	0.75	2.20	
2220	5750M	5.7 ±0.40	5.0 ±0.30	0.25	0.75	3.40	

Note: 1. Dimension for size 0603, C < 10 μF; 0805 to 1812, C ≤ 100 nF
 2. Dimension for size 0402, C ≥ 4.7 μF; 0603, C = 1 μF, 50V; 0805 to 1812, C > 100 nF

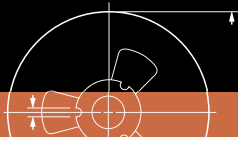

MLCC Selection Charts

X7R - General purpose & High capacitance , 01005 to 0402

X7R												
General purpose & High capacitance												
Capacitance	01005		0201					0402				
	6.3 V/10V	16 V	6.3 V	10 V	16 V	25 V	50 V	6.3 V	10 V	16 V	25 V	50 V
47 pF												
68 pF												
100 pF	0.2 ±0.02	0.2 ±0.02	0.3 ±0.03	0.3 ±0.03	0.3 ±0.03	0.3 ±0.03	0.3 ±0.03	0.5 ±0.05	0.5 ±0.05	0.5 ±0.05	0.5 ±0.05	0.5 ±0.05
150 pF												
220 pF												
330 pF												
470 pF												
680 pF												
1.0 nF												
1.5 nF												
2.2 nF												
3.3 nF												
4.7 nF												
6.8 nF												
10 nF												
15 nF												
22 nF												
33 nF												
47 nF												
68 nF												
100 nF			0.3 ±0.03									
150 nF												
220 nF											0.5 ±0.15	
330 nF												
470 nF								0.5 ±0.05	0.5 ±0.05			
680 nF												
1000 nF								0.5 ±0.05				
Tape width	8 mm											

Note: Values in shaded cells indicate thickness class (unit: mm)



MLCC Selection Charts

X7R - General purpose & High capacitance, 0603 / 0805

X7R										
General purpose & High capacitance										
Capacitance	0603					0805				
	6.3 V	10 V	16 V	25 V	50 V	6.3 V	10 V	16 V	25 V	50 V
100 pF										
150 pF										
220 pF										
330 pF										
470 pF										
680 pF										
1.0 nF										
1.5 nF										
2.2 nF						0.6 ±0.1	0.6 ±0.1	0.6 ±0.1	0.6 ±0.1	0.6 ±0.1
3.3 nF										
4.7 nF					0.8 ±0.1					
6.8 nF										
10 nF	0.8 ±0.1	0.8 ±0.1	0.8 ±0.1	0.8 ±0.1						
15 nF										
22 nF										
33 nF										
47 nF										
68 nF						0.85 ±0.1	0.85 ±0.1	0.85 ±0.1	0.85 ±0.1	0.85 ±0.1
100 nF										
150 nF										
220 nF										
330 nF										
470 nF					0.8 ±0.1					
680 nF										
1000 nF					0.8 ±0.15	1.25 ±0.2	1.25 ±0.2	1.25 ±0.2	1.25 ±0.2	1.25 ±0.2
2.2 µF										
4.7 µF										
10 µF										
Tape width	8 mm									

Note: Values in shaded cells indicate thickness class (unit: mm)



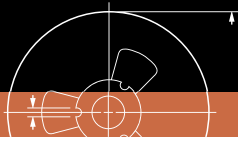

MLCC Selection Charts

X7R - General purpose & High capacitance, 1206 to 2220

X7R												
General purpose & High capacitance												
Capacitance	1206					1210					1812	2220
	6.3 V	10 V	16 V	25 V	50 V	6.3 V	10 V	16 V	25 V	50 V	50 V	50 V
220 pF												
330 pF												
470 pF												
680 pF												
1.0 nF												
1.5 nF												
2.2 nF												
3.3 nF												
4.7 nF												
6.8 nF												
10 nF	0.85 ±0.1	0.85 ±0.1	0.85 ±0.1	0.85 ±0.1	0.85 ±0.1							
15 nF										0.85 ±0.1		
22 nF						0.85 ±0.1	0.85 ±0.1	0.85 ±0.1	0.85 ±0.1		0.85 ±0.1	
33 nF												
47 nF												
68 nF												
100 nF												
150 nF												
220 nF										1.15 ±0.1	1.15 ±0.1	
330 nF												0.85 ±0.1
470 nF					1.0 ±0.1							
680 nF						1.15 ±0.1	1.15 ±0.1	1.15 ±0.1	1.15 ±0.1	1.25 ±0.2		
1000 nF	1.15 ±0.1	1.15 ±0.1	1.15 ±0.1	1.15 ±0.1		1.25 ±0.2	1.25 ±0.2	1.25 ±0.2	1.25 ±0.2		1.6 ±0.2	1.15 ±0.1
2.2 µF					1.6 ±0.2					1.9 ±0.2		
4.7 µF				1.6 ±0.2		1.9 ±0.2	1.9 ±0.2	1.9 ±0.2	1.9 ±0.2			
10 µF	1.6 ±0.2	1.6 ±0.2	1.6 ±0.2							2.5 ±0.3		
22 µF								2.5 ±0.2	2.5 ±0.2			
47 µF						2.5 ±0.2	2.5 ±0.2					
Tape width	8 mm											

Note: Values in shaded cells indicate thickness class (unit: mm)





Features

- Capable of operating at high voltage levels
- For high frequency snubber
- Decoupling / smoothing function

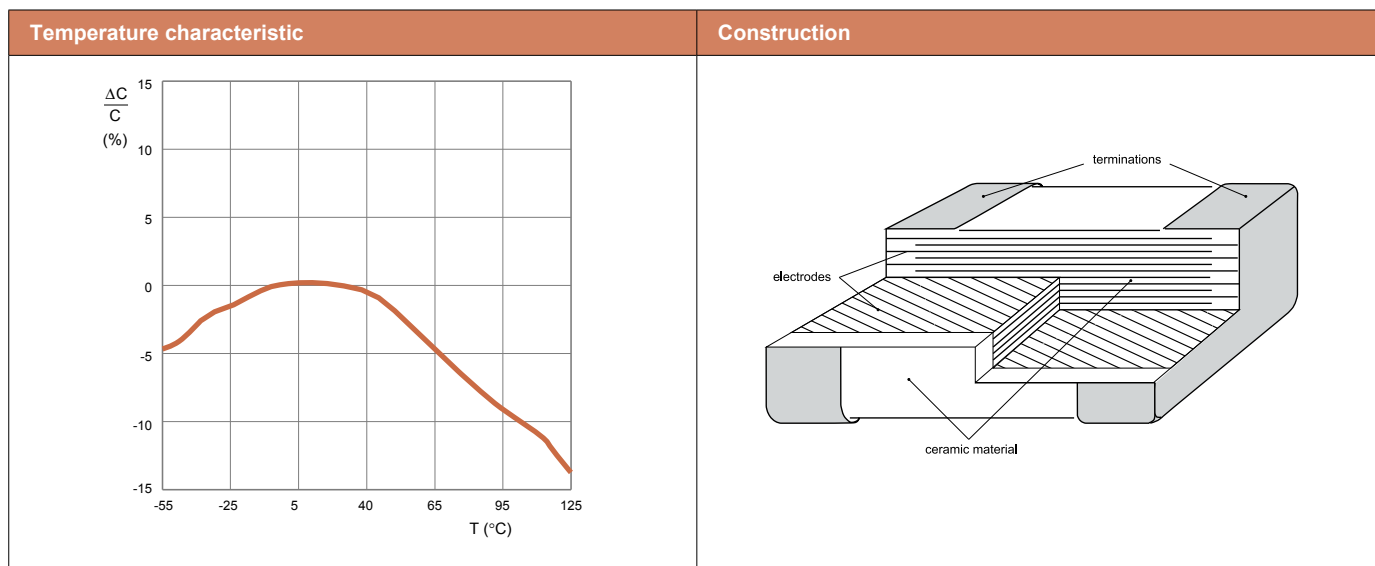

Dimensions							
Discrete capacitors - Medium and High voltage							
	Case size designation		Dimensions in mm				
	Inch-based	Metric	L ₁	W	L ₂ / L ₃ min	L ₂ / L ₃ max	L ₄ min
	0402	1005M	1.0 ±0.05	0.5 ±0.05	0.15	0.35	0.40
	0603	1608M	1.6 ±0.10	0.8 ±0.10	0.20	0.60	0.40
	0805	2012M	2.0 ±0.20	1.25 ±0.20	0.25	0.75	0.55
	1206	3216M	3.2 ±0.30	1.6 ±0.20	0.25	0.75	1.40
	1210	3225M	3.2 ±0.40	2.5 ±0.30	0.25	0.75	1.40
	1808	4520M	4.5 ±0.40	2.0 ±0.30	0.25	0.75	2.20
	1812	4532M	4.5 ±0.40	3.2 ±0.30	0.25	0.75	2.20



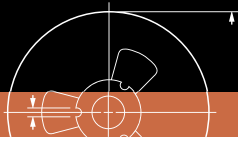

MLCC Selection Charts

X7R - Medium and High voltage, 0402 to 1210

X7R								
Medium voltage & High voltage								
Capacitance	0402	0603			0805			
	100 V	100 V	250 V	100 V	250 V	500 V	630 V	1000 V
100 pF								
150 pF								
220 pF								
330 pF								
470 pF								0.85 ±0.1
680 pF			0.8 ±0.1					
1.0 nF	0.5 ±0.05			0.6 ±0.1	0.85 ±0.1	0.85 ±0.1	0.85 ±0.1	
1.5 nF								1.25 ±0.2
2.2 nF								
3.3 nF		0.8 ±0.1						
4.7 nF								
6.8 nF								
10 nF								
15 nF								
22 nF				0.85 ±0.1		1.25 ±0.2		
33 nF								
47 nF								
68 nF								
100 nF								
150 nF				1.25 ±0.2				
220 nF								
470 nF								
1 µF								
Tape width	12 mm							

Note: Values in shaded cells indicate thickness class (unit: mm)

X7R													
Medium voltage & High voltage													
Capacitance	1206						1210						
	100 V	250 V	500 V	630 V	1000 V	2000 V	250 V	100 V	250 V	500 V	630 V	1000 V	2000 V
220 pF													
330 pF													
470 pF													
680 pF						1.25 ±0.2							1.25 ±0.2
1.0 nF							1.6 ±0.2						
1.5 nF					1.25 ±0.2							1.25 ±0.2	
2.2 nF		0.85 ±0.1	1.25 ±0.2	1.25 ±0.2									
3.3 nF	0.85 ±0.1												
4.7 nF													
6.8 nF									0.85 ±0.1		1.25 ±0.2		
10 nF													
15 nF								0.85 ±0.1		1.25 ±0.2			
22 nF													
33 nF		1.25 ±0.2	1.6 ±0.2	1.6 ±0.2							1.6 ±0.2	1.6 ±0.2	
47 nF													
68 nF									1.25 ±0.2				
100 nF	1.25 ±0.2	1.6 ±0.2											
150 nF								1.25 ±0.2					
220 nF													
330 nF								1.6 ±0.2					
470 nF	1.6 ±0.2							1.25 ±0.2					
680 nF													
1000 nF	1.6 ±0.2							2.0 ±0.2					
2.2 µF	1.6 ±0.3												
Tape width	12 mm												

Note: Values in shaded cells indicate thickness class (unit: mm)



MLCC Selection Charts

X7R - Medium and High voltage, 1808 / 1812

X7R														
Medium voltage & High voltage														
Capacitance	1808			1812										
	1000 V	2000 V	3000 V	100 V	250 V	500 V	630 V	1000 V	2000 V	3000 V				
150 pF			1.6 ±0.2											
220 pF														
330 pF		1.35 ±0.2												
470 pF	1.35 ±0.2													
680 pF														
1.0 nF				2.0 ±0.2	0.85 ±0.1	0.85 ±0.1	1.25 ±0.2	1.35 ±0.2	1.35 ±0.2	1.35 ±0.2	1.6 ±0.2			
1.5 nF														
2.2 nF		1.6 ±0.2												
3.3 nF														
4.7 nF														
6.8 nF														
10 nF	1.6 ±0.2													
15 nF														
22 nF														
33 nF												1.6 ±0.2	1.6 ±0.2	
47 nF														
68 nF														
100 nF					1.25 ±0.2	1.6 ±0.2								
150 nF				1.25 ±0.2										
220 nF					1.6 ±0.2									
330 nF														
470 nF														
680 nF				1.6 ±0.2										
1000 nF														
Tape width	12 mm													

Note: Values in shaded cells indicate thickness class (unit: mm)

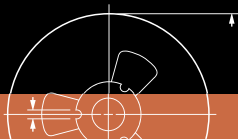

MLCC Selection Charts

X7R / X5R - Low inductance, 0204 to 0612



Features

- Good solution for anti-resonance reduction with controlled ESR
- Suitable for high speed IC decoupling due to low inductance type

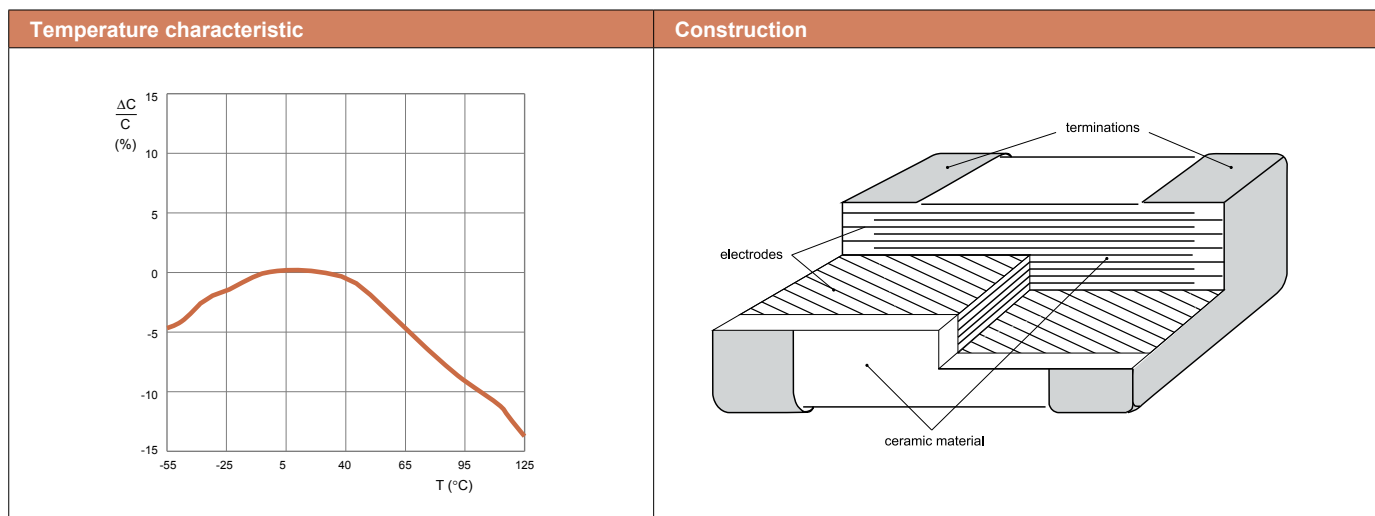

Dimensions								
Discrete capacitors - Low inductance types only								
	Case size designation		Dimensions in mm					
	Inch-based	Metric	L ₁	W	T	L ₂ / L ₃ min	L ₂ / L ₃ max	L ₄ min
	0204	0510M	0.5 ±0.10	1.0 ±0.10	0.30 ±0.10	0.10	0.30	0.10
	0306	0816M	0.8 ±0.15	1.6 ±0.20	0.50 ±0.10	0.10	0.30	0.20
	0508	1220M	1.25 ±0.20	2.0 ±0.20	0.85 ±0.10	0.13	0.46	0.38
	0612	1632M	1.6 ±0.20	3.2 ±0.20	0.85 ±0.10	0.13	0.46	0.50

X7R								X5R					
Low Inductance series								Low Inductance series					
Capacitance	0306	0508			0612			0204					
	10 V	10 V	16 V	25 V	16 V	25 V	50 V	10 V					
10 nF		0.85 ±0.1	0.85 ±0.1	0.85 ±0.1	0.85 ±0.1	0.85 ±0.1	0.85 ±0.1	0.3±0.1					
22 nF													
47 nF													
100 nF	0.5 ±0.1												
220 nF						1.15 ±0.1	1.15 ±0.1						
470 nF													
1000 nF					1.15 ±0.1								
Tape width	8 mm							8 mm					

Note: Values in shaded cells indicate thickness class (unit: mm)



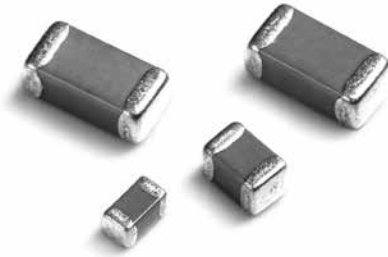

Features

- Flexible termination system
- Improved resistance to thermal stresses
- Increased mechanical performance

Construction

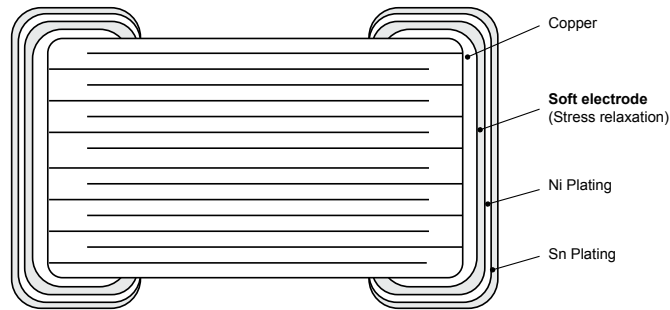

Dimensions

Discrete capacitors - Soft termination

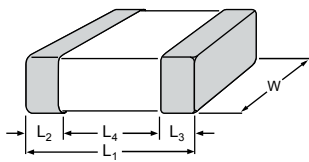

	Case size designation		Dimensions in mm				
	Inch-based	Metric	L1	W	L2 / L3 min	L2 / L3 max	L4 min
0402		1005M	1.0 ±0.15	0.5 ±0.15	0.10	0.35	0.20
0603		1608M	1.6 ±0.20	0.8 ±0.15	0.20	0.50	0.40
0805		2012M	2.0 ±0.30	1.25 ±0.20	0.25	0.75	0.55
1206		3216M	3.2 ±0.40	1.6 ±0.20	0.25	0.85	1.40
1210		3225M	3.2 ±0.40	2.5 ±0.30	0.25	0.85	1.40
1808		4520M	4.5 ±0.40	2.0 ±0.30	0.25	0.85	2.20
1812		4532M	4.5 ±0.40	3.2 ±0.20	0.25	0.85	2.20

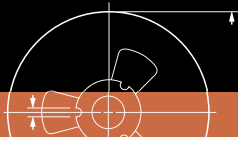

MLCC Selection Charts

NPO - Soft termination, 0402 to 0805

NPO											
Soft termination											
Capacitance	0402		0603			0805					
	50 V	100 V	50 V	100 V	250 V	50 V	100 V	250 V	500 V	630 V	1000 V
0.47 pF											
0.56 pF											
0.68 pF											
0.82 pF											
1 pF											
1.2 pF											
1.5 pF											
1.8 pF											
2.2 pF											
2.7 pF											
3.3 pF											
3.9 pF											
4.7 pF											
5.6 pF											
6.8 pF											
8.2 pF		0.5 ±0.15						0.6 ±0.15	0.6 ±0.15		
10 pF											
12 pF											
15 pF	0.5 ±0.15										
18 pF					0.8 ±0.15						
22 pF				0.8 ±0.15	0.8 ±0.15	0.6 ±0.15	0.6 ±0.15				0.85 ±0.15
27 pF											
33 pF											
39 pF			0.8 ±0.15							0.6 ±0.15	
47 pF											
56 pF											
68 pF											1.25 ±0.2
82 pF											
100 pF											
120 pF											
150 pF											
180 pF											
220 pF											
270 pF											
330 pF											
390 pF											
470 pF								0.85 ±0.15			
560 pF											
680 pF									1.25 ±0.2	1.25 ±0.2	
820 pF											
1000 pF											
1.2 nF											
1.5 nF						0.85 ±0.15	0.85 ±0.15				
1.8 nF											
2.2 nF											
2.7 nF								1.25 ±0.2			
3.3 nF											
3.9 nF											
4.7 nF						1.25 ±0.2	1.25 ±0.2				
5.6 nF											
6.8 nF											
8.2 nF											
10 nF											
Tape width							8 mm				

Note: Values in shaded cells indicate thickness class (unit: mm)



MLCC Selection Charts

NPO - Soft termination, 1206 / 1210

NPO														
Soft termination														
Capacitance	1206							1210						
	50 V	100 V	250 V	500 V	630 V	1000 V	2000 V	50 V	100 V	250 V	500 V	630 V	1000 V	2000 V
1 pF														
1.2 pF														
1.5 pF														
1.8 pF														
2.2 pF														
2.7 pF														
3.3 pF														
3.9 pF														
4.7 pF														
5.6 pF														
6.8 pF														
8.2 pF														
10 pF														
12 pF														
15 pF														
18 pF														
22 pF														
27 pF			0.6 ±0.15											
33 pF														
39 pF				0.6 ±0.15										
47 pF	0.6 ±0.15	0.6 ±0.15					1.25 ±0.2							
56 pF														
68 pF														
82 pF														
100 pF														
120 pF														
150 pF					1.25 ±0.2									
180 pF						1.25 ±0.2								
220 pF														
270 pF														
330 pF														
390 pF														
470 pF														
560 pF														
680 pF								1.25 ±0.2	1.25 ±0.2					
820 pF														
1000 pF			0.85 ±0.15	0.85 ±0.15										
1.2 nF														
1.5 nF														
1.8 nF														
2.2 nF				1.25 ±0.2										
2.7 nF			1.25 ±0.2											
3.3 nF														
3.9 nF														
4.7 nF	0.85 ±0.15	0.85 ±0.15												
5.6 nF														
6.8 nF														
8.2 nF	1.25 ±0.2	1.25 ±0.2												
10 nF														
22 nF														
Tape width	8 mm													

Note: Values in shaded cells indicate thickness class (unit: mm)



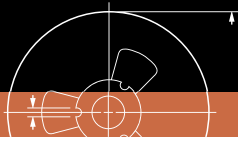

MLCC Selection Charts

NPO - Soft termination, 1808 / 1812

NPO										
Soft termination										
Capacitance	1808			1812						
	1 KV	2 KV	3K V	100 V	250 V	500 V	630 V	1000 V	2000 V	3000 V
10 pF			1.6 ±0.2					1.25 ±0.2	1.25 ±0.2	1.25 ±0.2
12 pF										
15 pF										
18 pF										
22 pF										
27 pF										
33 pF	1.25 ±0.2	1.25 ±0.2								
39 pF										
47 pF										
56 pF						1.25 ±0.2	1.25 ±0.2			
68 pF										
82 pF										
100 pF										
120 pF										
150 pF										
180 pF										
220 pF										
270 pF										
330 pF					1.25 ±0.2					
390 pF										
470 pF										
560 pF					1.25 ±0.2	1.25 ±0.2				
680 pF										
820 pF				1.25 ±0.2						
1000 pF										
1.2 nF										
1.5 nF										
1.8 nF										
2.2 nF										
2.7 nF										
3.3 nF										
3.9 nF										
4.7 nF										
5.6 nF										
6.8 nF										
8.2 nF										
10 nF										
22 nF										
Tape width	12mm									

Note: Values in shaded cells indicate thickness class (unit: mm)



MLCC Selection Charts

X7R - Soft termination, 0402 / 0603

X7R									
Soft termination									
Capacitance	0402				0603				
	16 V	25 V	50 V	100 V	16 V	25 V	50 V	100 V	250 V
100 pF									
150 pF									
220 pF									
330 pF									
470 pF									0.8 ±0.15
680 pF									
1.0 nF				0.5 ±0.15					
1.5 nF									
2.2 nF			0.5 ±0.15						
3.3 nF	0.5 ±0.15	0.5 ±0.15						0.8 ±0.15	
4.7 nF							0.8 ±0.15		
6.8 nF						0.8 ±0.15			
10 nF					0.8 ±0.15				
15 nF									
22 nF									
33 nF									
47 nF									
68 nF									
100 nF									
150 nF									
220 nF									
330 nF									
470 nF									
680 nF									
1000 nF									
Tape width	8 mm								

Note: Values in shaded cells indicate thickness class (unit: mm)

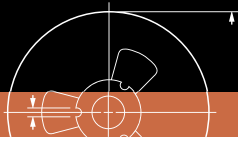

MLCC Selection Charts

X7R - Soft termination, 0805

X7R								
Soft termination								
Capacitance	0805							
	16 V	25 V	50 V	100 V	250 V	500 V	630 V	1000 V
150 pF	0.6 ±0.15	0.6 ±0.15	0.6 ±0.15	0.6 ±0.15	0.85 ±0.15	0.85 ±0.15	0.85 ±0.15	0.85 ±0.15
220 pF								
330 pF								
470 pF								
680 pF								
1.0 nF								
1.5 nF								
2.2 nF								
3.3 nF								
4.7 nF								
6.8 nF								
10 nF								
15 nF								
22 nF								
33 nF	0.85 ±0.15	0.85 ±0.15	0.85 ±0.15	1.25 ±0.2				
47 nF								
68 nF								
100 nF								
150 nF	1.25 ±0.2	1.25 ±0.2	1.25 ±0.2					
220 nF								
330 nF								
470 nF								
680 nF								
1000 nF								
2.2 µF								
4.7 µF	1.25 ±0.25							
Tape width	8 mm							

Note: Values in shaded cells indicate thickness class (unit: mm)



X7R																	
Soft termination																	
Capacitance	1206																
	16 V	25 V	50 V	100 V	250 V	500 V	630 V	1000 V	2000 V								
220 pF	0.85 ±0.15	0.85 ±0.15	0.85 ±0.15	0.85 ±0.15	0.85 ±0.15	1.25 ±0.2	1.25 ±0.2	1.25 ±0.2	1.25 ±0.2								
330 pF																	
470 pF																	
680 pF																	
1.0 nF																	
1.5 nF																	
2.2 nF																	
3.3 nF																	
4.7 nF																	
6.8 nF																	
10 nF																	
15 nF																	
22 nF																	
33 nF																	
47 nF										1.6 ±0.2	1.6 ±0.2	1.6 ±0.2	1.6 ±0.3	1.6 ±0.2	1.6 ±0.2	1.6 ±0.2	1.6 ±0.2
68 nF																	
100 nF																	
150 nF																	
220 nF																	
330 nF																	
470 nF																	
680 nF																	
1000 nF																	
2.2 μF																	
4.7 μF																	
10 μF																	
Tape width	12 mm																

Note: Values in shaded cells indicate thickness class (unit: mm)



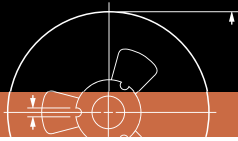

MLCC Selection Charts

X7R - Soft termination, 1210

X7R									
Soft termination									
Capacitance	1210								
	16 V	25 V	50 V	100 V	250 V	500 V	630 V	1000 V	2000 V
470 pF								1.25 ±0.3	1.25 ±0.3
680 pF									
1.0 nF									
1.5 nF									
2.2 nF	0.85 ±0.2	0.85 ±0.2	0.85 ±0.2	0.85 ±0.2	0.85 ±0.2	1.25 ±0.3	1.25 ±0.3	1.25 ±0.3	1.6 ±0.3
3.3 nF									
4.7 nF									
6.8 nF									
10 nF									
15 nF									
22 nF									
33 nF									
47 nF									
68 nF									
100 nF									
150 nF									
220 nF			1.15 ±0.3	1.25 ±0.3	1.25 ±0.3				
330 nF									
470 nF	1.15 ±0.3	1.15 ±0.3	1.25 ±0.3	2.0 ±0.3					
680 nF									
1000 nF	1.25 ±0.3	1.25 ±0.3							
2.2 µF				2.5 ±0.3					
4.7 µF	2.5 ±0.3	2.5 ±0.3	2.5 ±0.3						
10 µF									
Tape width	12 mm								

Note: Values in shaded cells indicate thickness class (unit: mm)



MLCC Selection Charts

X7R - Soft termination, 1808 / 1812

X7R			
Soft termination			
Capacitance	1808		
	1000 V	2000 V	3000 V
330 pF	1.35 ±0.4	1.35 ±0.4	1.6 ±0.4
470 pF			
680 pF			
1.0 nF			2.0 ±0.4
1.5 nF			
2.2 nF			
3.3 nF	1.6 ±0.4		
4.7 nF			
6.8 nF	1.6 ±0.4		
10 nF			
Tape width	12 mm		

Note: Values in shaded cells indicate thickness class (unit: mm)

X7R							
Soft termination							
Capacitance	1812						
	50 V	100 V	250 V	500 V	630 V	1000 V	2000 V
2.2 nF	0.85 ±0.3	0.85 ±0.3	0.85 ±0.3	1.25 ±0.4	1.35 ±0.4	1.35 ±0.4	1.35 ±0.4
3.3 nF							
4.7 nF							
6.8 nF							1.6 ±0.4
10 nF							
15 nF							
22 nF	1.15 ±0.4	1.25 ±0.4	1.25 ±0.4	1.6 ±0.4			
33 nF							
47 nF							
68 nF							
100 nF							
150 nF							
220 nF	1.6 ±0.4						
330 nF							
470 nF							
680 nF	1.6 ±0.4	1.6 ±0.4					
1000 nF							
Tape width	12 mm						

Note: Values in shaded cells indicate thickness class (unit: mm)



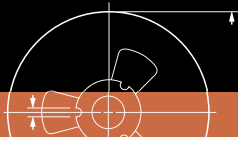

MLCC Selection Charts

X5R - General purpose & High capacitance, 01005 to 1210



Features

- Semi-stable on capacitance and high K
- High volumetric efficiency
- Highly reliable in high temperature application
- High insulation resistance

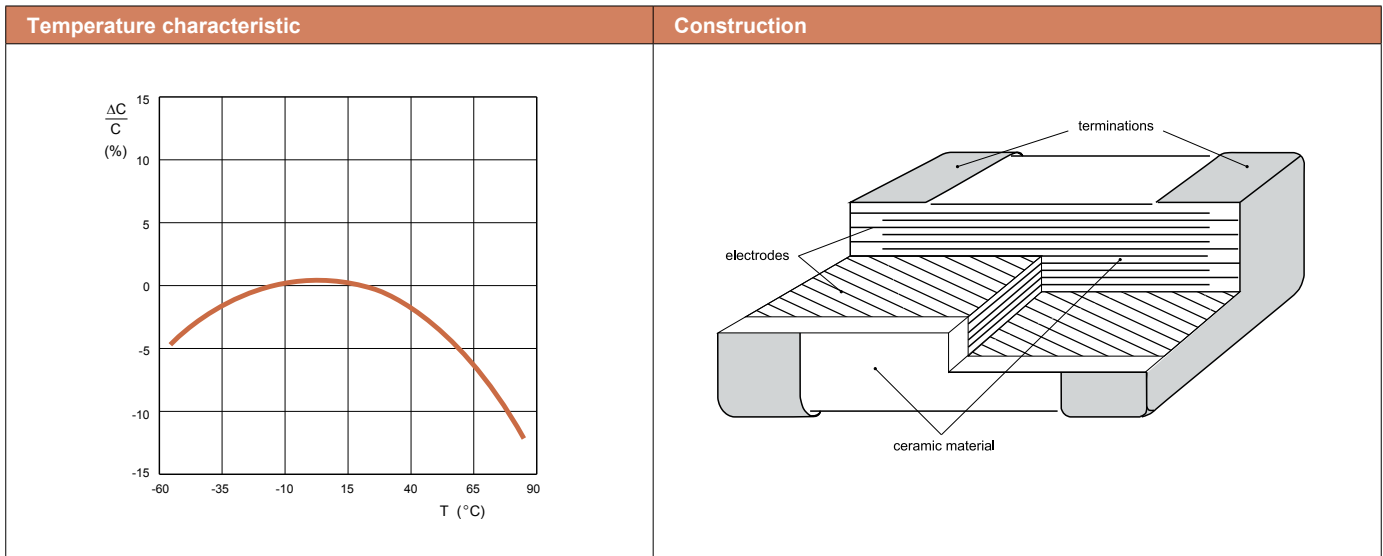

Case dimensions							
Discrete capacitors - General purpose & High capacitance							
	Case size designation		Dimensions in mm				
	Inch-based	Metric	L ₁	W	L ₂ / L ₃ min	L ₂ / L ₃ max	L ₄ min
	01005	0402M	0.4 ±0.02	0.2 ±0.02	0.07	0.14	0.14
0201	0603M	0.6 ±0.03 ⁽¹⁾	0.3 ±0.03 ⁽¹⁾	0.10	0.20	0.20	
		0.6 ±0.05 ⁽²⁾	0.3 ±0.05 ⁽²⁾	0.10	0.20	0.20	
0402	1005M	1.0 ±0.05 ⁽¹⁾	0.5 ±0.05 ⁽¹⁾	0.15	0.35	0.40	
		1.0 ±0.15 ⁽²⁾	0.5 ±0.15 ⁽²⁾	0.15	0.35	0.40	
		1.0 ±0.20 ⁽³⁾	0.5 ±0.20 ⁽³⁾	0.15	0.35	0.40	
0603	1608M	1.6 ±0.10 ⁽¹⁾	0.8 ±0.10 ⁽¹⁾	0.20	0.60	0.40	
		1.6 ±0.20 ⁽²⁾	0.8 ±0.20 ⁽²⁾	0.20	0.60	0.40	
0805	2012M	2.0 ±0.10 ⁽¹⁾	1.25 ±0.10 ⁽¹⁾	0.25	0.75	0.55	
		2.0 ±0.20 ⁽²⁾	1.25 ±0.20 ⁽²⁾	0.25	0.75	0.55	
1206	3216M	3.2 ±0.15 ⁽¹⁾	1.6 ±0.15 ⁽¹⁾	0.25	0.75	1.40	
		3.2 ±0.30 ⁽²⁾	1.6 ±0.20 ⁽²⁾	0.25	0.75	1.40	
1210	3225M	3.2 ±0.20 ⁽¹⁾	2.5 ±0.20 ⁽¹⁾	0.25	0.75	1.40	
		3.2 ±0.40 ⁽²⁾	2.5 ±0.30 ⁽²⁾	0.25	0.75	1.40	

Note: 1. Dimension for size 0201, C < 1 μF; 0402, C < 4.7 μF; 0603, C < 10 μF; 0805 to 1812, C ≤ 100 nF
 2. Dimension for size 0201, C ≥ 1 μF; 0402, C = 2.2 μF, 16V/25V and C = 4.7 μF; 0603, C ≥ 10 μF; 0805 to 1812, C > 100 nF
 3. Dimension for size 0402, C ≥ 10 μF



MLCC Selection Charts

X5R - General purpose & High capacitance, 01005 to 0402

X5R												
General purpose & High capacitance												
Capacitance	01005		0201					0402				
	6.3 V	10 V	6.3 V	10 V	16 V	25 V	50 V	6.3 V	10 V	16 V	25 V	50 V
100 pF	0.2 ±0.02	0.2 ±0.02										
150 pF												
220 pF	0.2 ±0.02	0.2 ±0.02										
330 pF							0.3 ±0.03					
470 pF	0.2 ±0.02	0.2 ±0.02										
680 pF												
1.0 nF	0.2 ±0.02	0.2 ±0.02										
1.5 nF												
2.2 nF	0.2 ±0.02	0.2 ±0.02										
3.3 nF												
4.7 nF	0.2 ±0.02	0.2 ±0.02	0.3 ±0.03	0.3 ±0.03	0.3 ±0.03	0.3 ±0.03				0.5 ±0.05	0.5 ±0.05	0.5 ±0.05
6.8 nF												
10 nF	0.2 ±0.02	0.2 ±0.02						0.5 ±0.05				
15 nF									0.5 ±0.05			
22 nF	0.2 ±0.02											
33 nF												
47 nF	0.2 ±0.02											
68 nF												
100 nF	0.2 ±0.02	0.2 ±0.02										
150 nF												
220 nF	0.2 ±0.02			0.3 ±0.03								0.5 ±0.05
330 nF												
470 nF	0.2 ±0.02		0.3 ±0.03	0.3 ±0.03						0.5 ±0.1	0.5 ±0.15	0.5 ±0.15
680 nF												
1 000 nF			0.3 ±0.05	0.3 ±0.05	0.3 ±0.09			*		0.5 ±0.05	0.5 ±0.05	0.5 ±0.2
2.2 µF			0.3 ±0.09	0.3 ±0.09				*		0.5 ±0.15	0.5 ±0.15	
4.7 µF								0.5 ±0.15*	0.5 ±0.15			
10 µF								0.5 ±0.2	0.5 ±0.2			
22 µF								0.5 ±0.2				
Tape width	8 mm											

Note: Values in shaded cells indicate thickness class (unit: mm)
 *: 0402 low profile, T=0.3±/-0.03mm.

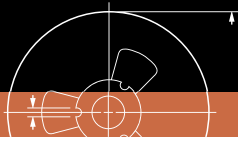

MLCC Selection Charts

X5R - General purpose & High capacitance, 0603 / 0805

X5R											
General purpose & High capacitance											
Capacitance	0603						0805				
	4 V	6.3 V	10 V	16 V	25 V	50 V	6.3 V	10 V	16 V	25 V	50 V
100 pF											
150 pF											
220 pF											
330 pF											
470 pF											
680 pF											
1.0 nF											
1.5 nF											
2.2 nF											
3.3 nF							0.6 ±0.1	0.6 ±0.1	0.6 ±0.1	0.6 ±0.1	0.6 ±0.1
4.7 nF											
6.8 nF	0.8 ±0.1	0.8 ±0.1	0.8 ±0.1	0.8 ±0.1	0.8 ±0.1	0.8 ±0.1					
10 nF											
15 nF											
22 nF											
33 nF											
47 nF											
68 nF											
100 nF							0.85 ±0.1	0.85 ±0.1	0.85 ±0.1	0.85 ±0.1	0.85 ±0.1
150 nF											
220 nF											
330 nF											
470 nF											
680 nF											
1 000 nF	*	*	*	*	*		1.25 ±0.2	1.25 ±0.2		1.25 ±0.2	1.25 ±0.2
2.2 µF	*	*	*			0.8 ±0.2	*	*	1.25 ±0.2		
4.7 µF				0.8 ±0.15	0.8 ±0.15		*	*			
10 µF				0.8 ±0.2	0.8 ±0.2		*	*			
22 µF	0.8 ±0.2	0.8 ±0.2	0.8 ±0.2								
47 µF											
100 µF											
Tape width	8 mm										

Note: Values in shaded cells indicate thickness class (unit: mm)
 *:0603 low profile, T=0.5±/0.05mm; 0805 low profile, T=0.85±/0.15mm



MLCC Selection Charts

X5R - General purpose & High capacitance, 1206

X5R					
General purpose & High capacitance					
Capacitance	1206				
	6.3 V	10 V	16 V	25 V	50 V
220 pF	0.85 ±0.1	0.85 ±0.1	0.85 ±0.1	0.85 ±0.1	0.85 ±0.1
330 pF					
470 pF					
680 pF					
1.0 nF					
1.5 nF					
2.2 nF					
3.3 nF					
4.7 nF					
6.8 nF					
10 nF					
15 nF					
22 nF					
33 nF					
47 nF					
68 nF					
100 nF					
150 nF					1.15 ±0.1
220 nF					
330 nF					1.0 ±0.1
470 nF					
680 nF	1.15 ±0.1	1.15 ±0.1	1.15 ±0.1	1.15 ±0.1	1.6 ±0.2
1 000 nF					
2.2 µF					
4.7 µF	1.6 ±0.2	1.6 ±0.2	1.6 ±0.2	1.6 ±0.2	1.6 ±0.3
10 µF				1.6 ±0.3	
22 µF					
47 µF					
100 µF				1.6 ±0.3	1.6 ±0.3
Tape width	8 mm				

Note: Values in shaded cells indicate thickness class (unit: mm)



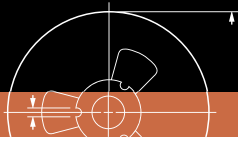

MLCC Selection Charts

X5R - General purpose & High capacitance, 1210

X5R					
General purpose & High capacitance					
Capacitance	1210				
	6.3 V	10 V	16 V	25 V	50 V
2.2 nF	0.85 ±0.1	0.85 ±0.1	0.85 ±0.1	0.85 ±0.1	0.85 ±0.1
3.3 nF					
4.7 nF					
6.8 nF					
10 nF					
15 nF					
22 nF					
33 nF					
47 nF					
68 nF					
100 nF					
150 nF					
220 nF					
330 nF					
470 nF	1.15 ±0.1	1.15 ±0.1	1.15 ±0.1	1.15 ±0.1	1.15 ±0.1
680 nF					
1 000 nF	1.25 ±0.2	1.25 ±0.2	1.25 ±0.2	1.25 ±0.2	1.25 ±0.2
2.2 µF	1.9 ±0.2	1.9 ±0.2	1.9 ±0.2	1.9 ±0.2	1.9 ±0.2
4.7 µF					
10 µF					
22 µF	2.5 ±0.2	2.5 ±0.2	2.5 ±0.2	2.5 ±0.3	
47 µF					
100 µF	2.5 ±0.3	2.5 ±0.3	2.5 ±0.3		
220 µF					
Tape width	8 mm				

Note: Values in shaded cells indicate thickness class (unit: mm)



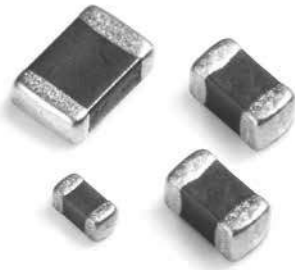

Features

- High volumetric efficiency
- Non-polar construction

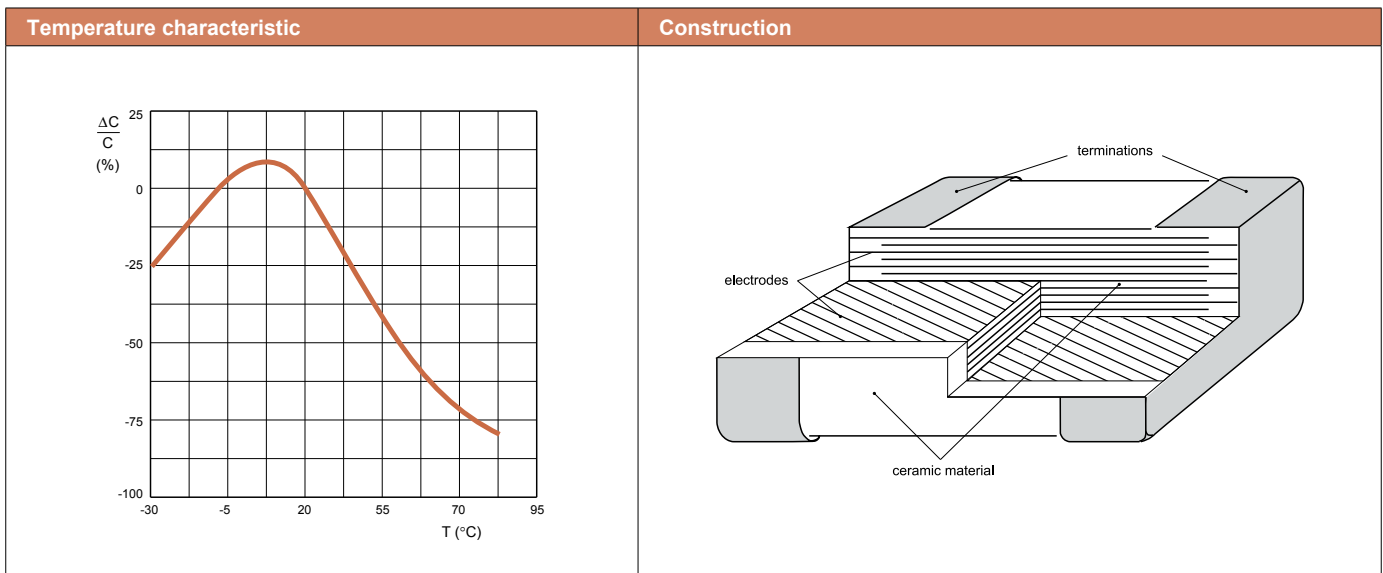

Case dimensions							
Discrete capacitors - General purpose & High capacitance							
	Case size designation		Dimensions in mm				
	Inch-based	Metric	L ₁	W	L ₂ / L ₃ min	L ₂ / L ₃ max	L ₄ min
	0402	1005M	1.0 ±0.05 ⁽¹⁾	0.5 ±0.05 ⁽¹⁾	0.15	0.35	0.40
1.0 ±0.20 ⁽²⁾			0.5 ±0.20 ⁽²⁾	0.15	0.35	0.40	
0603	1608M	1.6 ±0.10 ⁽¹⁾	0.8 ±0.10 ⁽¹⁾	0.20	0.60	0.40	
		1.6 ±0.15 ⁽²⁾	0.8 ±0.15 ⁽²⁾	0.20	0.60	0.40	
0805	2012M	2.0 ±0.10 ⁽¹⁾	1.25 ±0.10 ⁽¹⁾	0.25	0.75	0.55	
		2.0 ±0.20 ⁽²⁾	1.25 ±0.20 ⁽²⁾	0.25	0.75	0.55	
1206	3216M	3.2 ±0.15 ⁽¹⁾	1.6 ±0.15 ⁽¹⁾	0.25	0.75	1.40	
		3.2 ±0.30 ⁽²⁾	1.6 ±0.20 ⁽²⁾	0.25	0.75	1.40	
1210	3225M	3.2 ±0.20 ⁽¹⁾	2.5 ±0.20 ⁽¹⁾	0.25	0.75	1.40	
		3.2 ±0.40 ⁽²⁾	2.5 ±0.30 ⁽²⁾	0.25	0.75	1.40	

Note: 1. Dimension for size 0402, C < 4.7 μF; 0603, C < 10 μF; 0805 to 1210, C ≤ 100 nF
 2. Dimension for size 0402, C ≥ 4.7 μF; 0603, C ≥ 10 μF; 0805 to 1210, C > 100 nF



MLCC Selection Charts

Y5V - General purpose & High capacitance 6.3 to 50V, 0402 to 1210

Y5V					
General purpose & High capacitance					
Capacitance	0402				
	6.3 V	10 V	16 V	25 V	50 V
10 nF	0.5 ±0.05	0.5 ±0.05	0.5 ±0.05	0.5 ±0.05	0.5 ±0.05
22 nF					
47 nF					
100 nF					
220 nF					
470 nF					
1000 nF					
Tape width					8 mm

Note: Values in shaded cells indicate thickness class (unit: mm)

Y5V										
General purpose & High capacitance										
Capacitance	0603					0805				
	6.3 V	10 V	16 V	25 V	50 V	6.3 V	10 V	16 V	25 V	50 V
10 nF	0.8 ±0.1	0.8 ±0.1	0.8 ±0.1	0.8 ±0.1	0.8 ±0.1	0.6 ±0.1	0.6 ±0.1	0.6 ±0.1	0.6 ±0.1	0.6 ±0.1
22 nF										
47 nF										
100 nF										
220 nF										
470 nF										
1000 nF										
2.2 µF										
4.7 µF										
10 µF						1.25 ±0.2	1.25 ±0.2	1.25 ±0.2		
22 µF										
Tape width	8 mm									

Note: Values in shaded cells indicate thickness class (unit: mm)

Y5V										
General purpose & High capacitance										
Capacitance	1206					1210				
	6.3 V	10 V	16 V	25 V	50 V	6.3 V	10 V	16 V	25 V	50 V
10 nF	0.6 ±0.1	0.6 ±0.1	0.6 ±0.1	0.6 ±0.1	0.6 ±0.1					
22 nF										
47 nF										
100 nF										
220 nF										
470 nF										
1000 nF										
2.2 µF										
4.7 µF										
10 µF			1.15 ±0.1	1.6 ±0.2		1.5 ±0.1	1.5 ±0.1	1.5 ±0.1	1.5 ±0.1	1.5 ±0.1
22 µF	1.6 ±0.2	1.6 ±0.2	1.6 ±0.2			1.6 ±0.2	1.6 ±0.2	1.6 ±0.2		
47 µF										
Tape width	8 mm									

Note: Values in shaded cells indicate thickness class (unit: mm)



Features

- AEC-Q200 qualified
- MSL class: MSL 1
- J-STD-020D and TS-16949 compliant
- Halogen free epoxy
- RoHS compliant

Applications

- All general purpose applications
- Entertainment applications
- Comfort / security applications
- Information applications



Construction

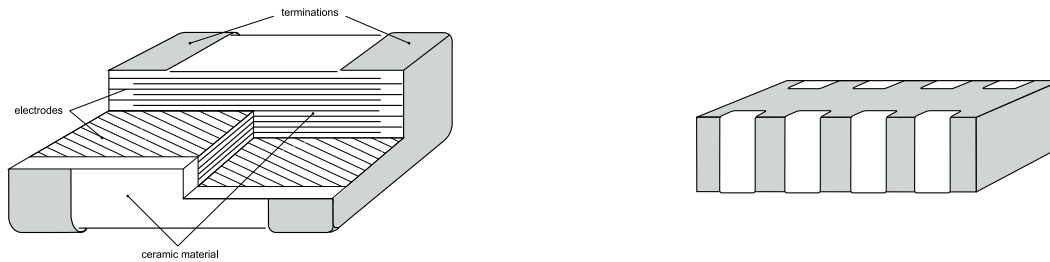

Dimensions

Discrete capacitors - Automotive grade

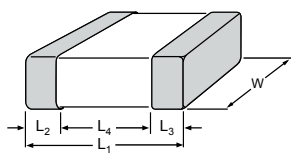

	Case size designation		Dimensions in mm				
	Inch-based	Metric	L1	W	L2 / L3 min	L2 / L3 max	L4 min
0201		0603M	0.6 ±0.03	0.3 ±0.03	0.10	0.20	0.20
0402		1005M	1.0 ±0.05	0.5 ±0.05	0.15	0.35	0.40
0603		1608M	1.6 ±0.20	0.8 ±0.10	0.20	0.60	0.40
0805		2012M	2.0 ±0.20	1.25 ±0.20	0.25	0.75	0.55
1206		3216M	3.2 ±0.30	1.6 ±0.20	0.25	0.75	1.40
1210		3225M	3.2 ±0.30	2.5 ±0.20	0.25	0.75	1.40
1812		4532M	4.5 ±0.40	3.2 ±0.30	0.25	0.75	2.20

Dimensions

4C arrays

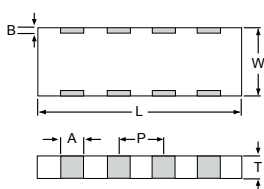

	Case size designation		Dimensions in mm						
	Inch-based	Metric	L	W	T _{min}	T _{max}	A	B	P
0508 (4 x 0402)		1220M (4 x 1005)	2.0 ±0.15	1.25 ±0.15	0.50	0.70	0.28 ±0.10	0.2 ±0.10	0.5 ±0.10
0612 (4 x 0603)		1632M (4 x 1608)	3.2 ±0.15	1.60 ±0.15	0.70 ⁽¹⁾	0.90 ⁽¹⁾	0.4 ±0.10	0.3 ±0.20	0.8 ±0.10

Note: 1. Available for NPO and X7R



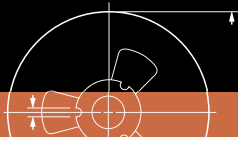

MLCC Selection Charts

NPO - Automotive grade, 0201 to 0805

NPO								
Automotive Grade								
Capacitance	0201	0402		0603			0805	
	50V	50V	50V	100V	250V	50V	100V	250V
0.47 pF	0.3 ±0.03	0.5 ±0.05	0.8 ±0.1	0.8 ±0.1	0.8 ±0.1	0.6 ±0.1	0.6 ±0.1	0.6 ±0.1
0.56 pF								
0.68 pF								
0.82 pF								
1 pF								
1.2 pF								
1.5 pF								
1.8 pF								
2.2 pF								
2.7 pF								
3.3 pF								
3.9 pF								
4.7 pF								
5.6 pF								
6.8 pF								
8.2 pF								
10 pF								
12 pF								
15 pF								
18 pF								
22 pF								
27 pF								
33 pF								
39 pF								
47 pF								
56 pF								
68 pF								
82 pF								
100 pF								
120 pF								
150 pF								
180 pF								
220 pF								
270 pF								
330 pF								
390 pF								
470 pF								
560 pF								
680 pF								
820 pF								
1 000 pF								
1.2 nF								
1.5 nF						0.85 ±0.1		
1.8 nF								
2.2 nF								
2.7 nF								
3.3 nF								
3.9 nF								
4.7 nF								
5.6 nF								
6.8 nF								
8.2 nF								
10 nF								
Tape width	8 mm							

Note: Values in shaded cells indicate thickness class (unit: mm)



MLCC Selection Charts

NPO / X8G - Automotive grade / High Frequency, 0603 to 1210

NPO										
Automotive Grade										
Capacitance	1206					1210				
	50V	100V	250V	500V	630V	50V	100V	250V	500 V	
47 pF										
56 pF										
68 pF										
82 pF										
100 pF										
120 pF										
150 pF										
180 pF			0.6 ±0.1	0.6 ±0.1						
220 pF					1.25 ±0.2					
270 pF										
330 pF	0.6 ±0.1	0.6 ±0.1								
390 pF										
470 pF										
560 pF										
680 pF										
820 pF										
1000 pF			0.85 ±0.1	0.85 ±0.1						
1.2 nF										1.25 ±0.2
1.5 nF										
1.8 nF						1.25 ±0.2	1.25 ±0.2	1.25 ±0.2		
2.2 nF										
2.7 nF										
3.3 nF										
3.9 nF										
4.7 nF										
5.6 nF										
6.8 nF										
8.2 nF										
10 nF										
Tape width	8 mm									

Note: Values in shaded cells indicate thickness class (unit: mm)

NPO			
Automotive Grade High Frequency			
Capacitance	0603		
	16V	25V	50V
0.2 pF			
0.3 pF			
0.4 pF			
0.5 pF			
0.6 pF			
0.7 pF			
0.8 pF			
0.9 pF			
1 pF			
1.2 pF			
1.5 pF			
1.8 pF			
2.2 pF			
2.7 pF			
3.3 pF			
3.9 pF			
4.7 pF	0.8 ±0.1	0.8 ±0.1	0.8 ±0.1
5.6 pF			
6.8 pF			
8.2 pF			
10 pF			
12 pF			
15 pF			
18 pF			
22 pF			
27 pF			
33 pF			
39 pF			
47 pF			
56 pF			
68 pF			
82 pF			
100 pF			
Tape width	8 mm		

X8G		
Automotive Grade		
Capacitance	0805	
	50 V	100 V
1 nF		
2.2 nF	0.6 ±0.1	0.6 ±0.1
4.7 nF		
10 nF	0.85 ±0.1	0.85 ±0.1
Tape width	8 mm	

Note: Values in shaded cells indicate thickness class (unit: mm)



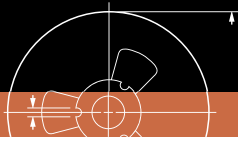

MLCC Selection Charts

X7R - Automotive grade, 0201 / 0402 / 0603

X7R												
Automotive grade												
Capacitance	0201		0402				0603					
	25 V	50 V	10 V	16 V	25 V	50 V	10 V	16 V	25 V	50 V	100 V	
100 pF	0.3 ±0.03	0.3 ±0.03										
150 pF												
180 pF												
220 pF												
330 pF												
390 pF												
470 pF												
680 pF												
1000 pF												
1.5 nF								0.5 ±0.05				
2.2 nF												
3.3 nF												
4.7 nF												
6.8 nF			0.5 ±0.05	0.5 ±0.05	0.5 ±0.05							
10 nF												
15 nF										0.8 ±0.1		
18 nF									0.8 ±0.1			
22 nF												
27 nF							0.8 ±0.1	0.8 ±0.1				
33 nF												
47 nF												
68 nF												
100 nF												
150 nF												
220 nF												
270 nF												
330 nF												
390 nF												
470 nF												
680 nF												
1000 nF							0.8 ±0.1	0.8 ±0.1	0.8 ±0.1			
Tape width	8 mm											

Note: Values in shaded cells indicate thickness class (unit: mm)



MLCC Selection Charts

X7R / X8R - Automotive grade, 0805

X7R							
Automotive grade							
Capacitance	0805						
	10 V	16 V	25 V	50 V	100 V	250 V	500 V
1000 pF	0.85 ±0.1	0.85 ±0.1	0.85 ±0.1	0.85 ±0.1	0.85 ±0.1	0.85 ±0.1	0.85 ±0.1
1.5 nF							
2.2 nF							
3.3 nF							
4.7 nF							
6.8 nF							
10 nF							
15 nF							
18 nF							
22 nF							
27 nF							
33 nF							
47 nF							
68 nF							
100 nF							
150 nF							
220 nF							
270 nF							
330 nF							
390 nF							
470 nF							
680 nF							
1000 nF							
2.2 µF							
4.7 µF							
Tape width	8 mm						

Note: Values in shaded cells indicate thickness class (unit: mm)

X8R			
Automotive Grade			
Capacitance	0805		
	16 V	25 V	50 V
22 nF	1.25 ±0.2	1.25 ±0.2	1.25 ±0.2
33 nF			
47 nF			
68 nF			
100 nF			
Tape width	8 mm		

Note: Values in shaded cells indicate thickness class (unit: mm)



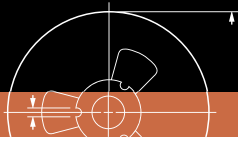

MLCC Selection Charts

X7R - Automotive grade, 1206 / 1210 / 1812

X7R							
Automotive grade							
Capacitance	1206						
	6.3 V	10 V	16 V	25V	50V	100V	250 V
22 nF	0.85 ±0.1	0.85 ±0.1	0.85 ±0.1	0.85 ±0.1	0.85 ±0.1	0.85 ±0.1	1.25 ±0.2
27 nF							1.6 ±0.2
33 nF							
47 nF							
68 nF							
100 nF							
150 nF					1.25 ±0.2		
220 nF					1.6 ±0.2	1.6 ±0.2	
270 nF							
330 nF							
390 nF							
470 nF							
680 nF	1.15 ±0.1	1.15 ±0.1	1.15 ±0.1	1.15 ±0.1	1.6 ±0.2	1.6 ±0.2	
1000 nF	1.6 ±0.2	1.6 ±0.2	1.6 ±0.2	1.6 ±0.2			
2.2µF	1.6 ±0.2	1.6 ±0.2	1.6 ±0.2	1.6 ±0.2			
Tape width	8 mm						

Note: Values in shaded cells indicate thickness class (unit: mm)

X7R										
Automotive grade										
Capacitance	1210							1812		
	6.3 V	10 V	16 V	25V	50V	100V	250 V	50 V	100 V	
100 nF	0.85 ±0.1	0.85 ±0.1	0.85 ±0.1	0.85 ±0.1	0.85 ±0.1	0.85 ±0.1	1.25 ±0.2			
150 nF					1.25 ±0.2					
220 nF						1.25 ±0.2				
270 nF					2.0 ±0.2					
330 nF							1.6 ±0.2	1.6 ±0.2		
390 nF	1.25 ±0.2	1.25 ±0.2	1.25 ±0.2	1.25 ±0.2	1.6 ±0.2	1.6 ±0.2				
470 nF							2.0 ±0.2	2.0 ±0.2		
680 nF	2.5 ±0.2	2.5 ±0.2								
1000 nF			2.0 ±0.2	2.0 ±0.2						
2.2µF	2.5 ±0.2	2.5 ±0.2								
4.7µF										
Tape width	12 mm									

Note: Values in shaded cells indicate thickness class (unit: mm)



MLCC Selection Charts

NPO / X7R - Automotive grade 4-C Arrays, 0508, 0612

NPO		
4-C arrays		
Capacitance	0508	0612
	6.3 V	10 V
10 pF	0.6 ±0.1	0.8 ±0.1
12 pF		
15 pF		
18 pF		
22 pF		
33 pF		
39 pF		
47 pF		
56 pF		
68 pF		
82 pF		
100 pF		
120 pF		
150 pF		
180 pF		
220 pF		
330 pF		
390 pF		
470 pF		
Tape width	8 mm	

Note: Values in shaded cells indicate thickness class (unit: mm)

X7R							
4-C arrays							
Capacitance	0508			0612			
	16 V	25 V	50 V	16 V	25 V	50 V	
220 pF				0.8 ±0.1	0.8 ±0.1	0.8 ±0.1	
330 pF							
470 pF							
680 pF							
1 nF	0.6 ±0.1	0.6 ±0.1	0.6 ±0.1				
1.2 nF							
1.5 nF							
1.8 nF							
2.2 nF							
2.7 nF							
3.3 nF							
4.7 nF							
5.6 nF							
6.8 nF							
8.2 nF							
10 nF							
12 nF							
15 nF							
18 nF							
22 nF							
27 nF							
33 nF							
47 nF							
56 nF							
68 nF							
82 nF							
100 nF							
Tape width	8 mm						

Note: Values in shaded cells indicate thickness class (unit: mm)



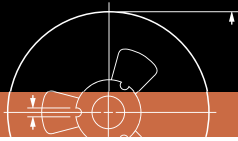

MLCC Selection Charts

X7R - Automotive grade with Soft termination, 0805 to 1210

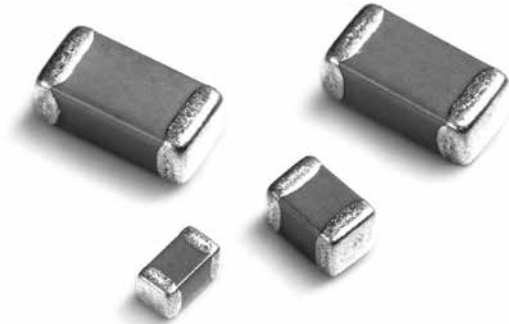

Features

- AEC-Q200 qualified
- MSL class: MSL 1
- J-STD-020D and TS-16949 compliant
- Halogen free epoxy
- RoHS compliant
- Flexible termination system
- Increased mechanical performance

Applications

- All general purpose applications
- Entertainment applications
- Comfort / security applications
- Information applications

Construction

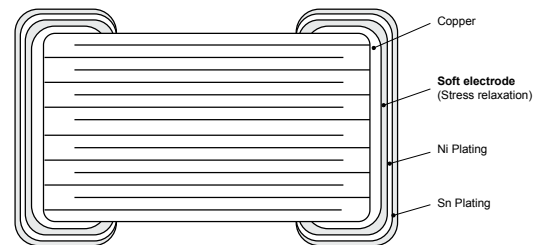
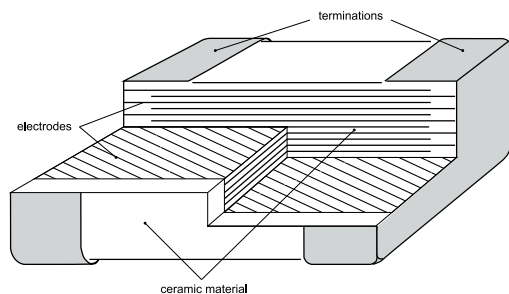

Dimensions

Discrete capacitors - Automotive grade

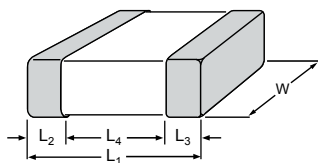

Case size designation		Dimensions in mm				
Inch-based	Metric	L1	W	L2 / L3 min	L2 / L3 max	L4 min
0805	2012M	2.0 ±0.30	1.25 ±0.20	0.25	0.75	0.70
1206	3216M	3.2 ±0.40	1.6 ±0.20	0.25	0.75	1.50
1210	3225M	3.2 ±0.50	2.5 ±0.30	0.25	0.85	1.40



MLCC Selection Charts

X7R - Automotive grade with Soft termination, 0805 to 1210

X7R								
Automotive grade								
Capacitance	0603			0805				
	25 V	50 V	100 V	10 V	16 V	25 V	50 V	100 V
1.0 nF				0.85 ±0.15	0.85±0.15	0.85 ±0.15	0.85 ±0.15	0.85 ±0.15
1.5 nF								
2.2 nF								
3.3 nF								
4.7 nF								
6.8 nF								
10 nF								
15 nF								
22 nF	0.8 ±0.15	0.8 ±0.15	0.8 ±0.15					
33 nF								
47 nF								
68 nF								
100 nF								
Tape width	8 mm							

Note: Values in shaded cells indicate thickness class (unit: mm)

X7R							
Automotive grade							
Capacitance	1206						
	6.3 V	10V	16V	25V	50 V	100 V	250 V
22 nF	0.85 ±0.15	0.85 ±0.15	0.85 ±0.15	0.85 ±0.15	0.85 ±0.15	0.85 ±0.15	1.25 ±0.2
33 nF							
47 nF							
68 nF							
100 nF							
150 nF	1.25 ±0.2	1.25 ±0.2	1.25 ±0.2	1.25 ±0.2	1.25 ±0.2	1.6 ±0.2	
220 nF							
Tape width	8 mm						

Note: Values in shaded cells indicate thickness class (unit: mm)

X7R				
Automotive grade				
Capacitance	1210			
	25V	50 V	100 V	250 V
100 nF				
150 nF	1.25 ±0.2	1.25 ±0.2	1.25 ±0.2	1.25 ±0.2
220 nF				
4.7 μF	2.5 ±0.3	2.5 ±0.3		
Tape width	8 mm			

Note: Values in shaded cells indicate thickness class (unit: mm)

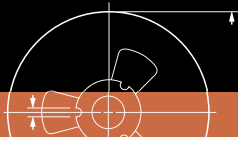

MLCC Selection Charts

NPO / X7R - 4C Arrays, 0508 / 0612



Features

- Less than 50% board space of an equivalent discrete component
- High volumetric efficiency
- Increased throughput, by time saved in mounting

Temperature characteristic

NPO

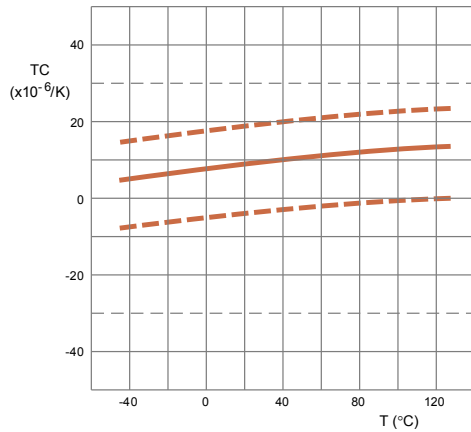

X7R

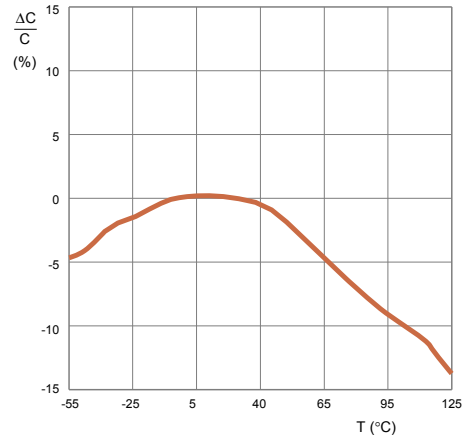

Dimensions

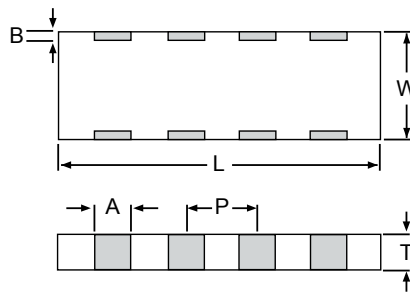

Dimensions

4C arrays

Case size designation		Dimensions in mm						
Inch-based	Metric	L	W	T _{min}	T _{max}	A	B	P
0508 (4 x 0402)	1220M (4 x 1005)	2.0 ±0.15	1.25 ±0.15	0.50	0.70	0.28 ±0.10	0.2 ±0.10	0.5 ±0.10
0612 (4 x 0603)	1632M (4 x 1608)	3.2 ±0.15	1.60 ±0.15	0.70	0.90	0.4 ±0.10	0.3 ±0.20	0.8 ±0.10



MLCC Selection Charts

NPO - 4C Arrays, 0508 / 0612

NPO				
4C arrays				
Capacitance	0508		0612	
	50 V	100 V	50 V	100 V
10 pF	0.6 ±0.1	0.6 ±0.1	0.8 ±0.1	0.8 ±0.1
15 pF				
18 pF				
22 pF				
27 pF				
47 pF				
100 pF				
150 pF				
180 pF				
220 pF				
270 pF				
330 pF				
390 pF				
470 pF				
Tape width	8 mm			

Note: Values in shaded cells indicate thickness class (unit: mm)

X7R										
4C arrays										
Capacitance	0508			0612						
	16 V	25 V	50 V	16 V	25 V	50 V	100 V			
1 nF	0.6 ±0.1	0.6 ±0.1	0.6 ±0.1	0.8 ±0.1	0.8 ±0.1	0.8 ±0.1				
1.2 nF										
1.5 nF										
1.8 nF										
2.2 nF										
2.7 nF										
3.3 nF										
4.7 nF										
5.6 nF										
6.8 nF										
8.2 nF										
10 nF										
12 nF										
15 nF										
18 nF										
22 nF										
27 nF										
33 nF										
47 nF										
56 nF										
68 nF										
82 nF										
100 nF										
Tape width	8 mm									

Note: Values in shaded cells indicate thickness class (unit: mm)



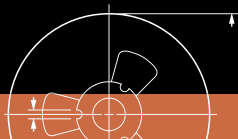

MLCC Sample Books

Sample Books

Sample book (small)	Description	Size	Volt.	Cap range
CC0402000000SB000	CC0402 Commodity	0402	≤ 50V	<1μF
CC0603000000SB000	CC0603 Commodity	0603	≤ 50V	<1μF
CC0805000000SB000	CC0805 Commodity	0805	≤ 50V	<1μF
CC1206000000SB000	CC1206 Commodity	1206	≤ 50V	<1μF
CQ0201000000SB000	HiQ 0201	0201	25V	0.2pF to 10pF
CQ0402000000SB000	HiQ 0402	0402	50V	0.2pF to 33pF
CQ0603000000SB000	HiQ 0603	0603	50V	0.2pF to 47pF
CQ0805000000SB000	HiQ 0805	0805	250V	0.2pF to 100pF
HV777S00000000000	Hi-Voltage sample book	0805 to 1206	100V to 630V	47pF to 1μF
AC7777000000SB000	AC sample book	0402 to 1206	16V to 100V	10pF to 1μF
HC8888000000SB000	Hi-Cap Series	0201 to 1210	6.3V to 25V	1μF to 220μF
HCV8888000000SB000	HCV Series	0402 to 1210	6.3V to 100V	1μF to 22μF
SS1111000000SB000	CC Small Size series	01005 + 0201	6.3V to 50V	0.5pF to 2.2μF
CS8888000000SB000	Soft termination Series	0402 to 1206	16V to 1000V	100pF to 1μF



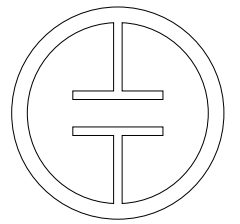

SMD CERAMIC EMI FILTER CAPACITORS
X2Y[®] PRODUCTS

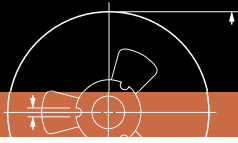

X2Y® Product Selection Charts

SMD ceramic EMI filter capacitors X2Y® series



Features

- Broadband Filtering and Decoupling: X2Y® is effective up to 10 GHz and frequencies beyond
- Ultra Low ESL: Noise cancellation within X2Y® makes ESL reducing from nanohenry to picohenry levels
- Bypass: Unlike feedthrough capacitors, X2Y® is in bypass, so no DC current limitations
- Matched Y-caps: Two tightly matched line to ground capacitors in one device
- Superior Balance: Temperature and voltage variations balanced of two Y-caps
- Aging Reliability: Aging effects are equal on two Y-caps

Circuit of typical applications

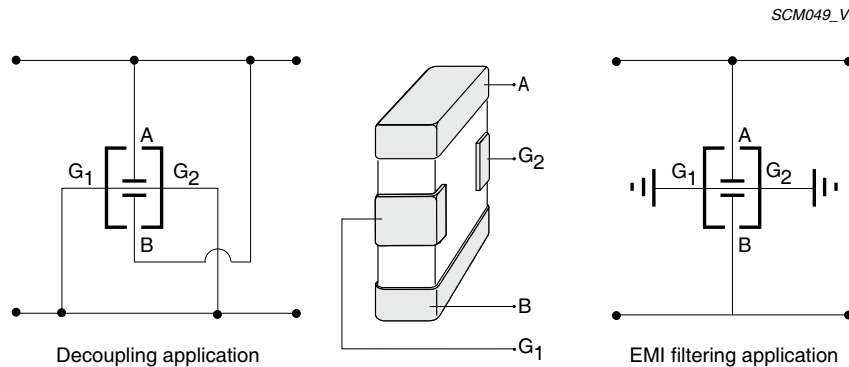

Benefits

- Fewer Components in Filtering: One X2Y® can replace multiple inductors and/or capacitors
- Superior Performance in Filtering: One X2Y® can eliminate both differential and common mode noises
- Fewer Components in Decoupling: Up to 1:7 replacement of MLCC in power delivering system bypass networks
- Superior Performance in Decoupling: Large or small, X2Y® components exhibit ultra low ESL
- Total Cost Savings: Assembly cost savings through reduced component count and placement costs
- Board Level Design Advantages: Dramatically reduces via drills, which blocks routing

Applications

- EMI filtering on DC motors
- Filtered connectors (airbag connectors, RJ-45 connectors)
- High speed data-line filtering
- Decoupling of supply-lines in high speed digital circuits
- Broadband filtering
- Amplifier decoupling and EMI suppression
- IC Decoupling, on-package, on-PCB
- DC power line filtering
- Data line filtering
- EMI suppression for DC motors
- Sensors
- Audio



X7R					
Size	Y-Capacitor		Voltage rating (V)	Thickness (mm)	Global part number
	Capacitance (nF)	Tolerance (%)			
0603	1	20%	100	0.65	CX 0603 MR X7R 0BB 102
	1.5	20%	100	0.65	CX 0603 MR X7R 0BB 152
	2.2	20%	100	0.65	CX 0603 MR X7R 0BB 222
	4.7	20%	100	0.65	CX 0603 MR X7R 0BB 472
	5.6	20%	100	0.65	CX 0603 MR X7R 0BB 562
	10	20%	50 / 63	0.65	CX 0603 MR X7R 9BB 103
	15	20%	25	0.65	CX 0603 MR X7R 8BB 153
	18	20%	25	0.65	CX 0603 MR X7R 8BB 183
	22	20%	25	0.65	CX 0603 MR X7R 8BB 223
	39	20%	16	0.65	CX 0603 MR X7R 7BB 393
	47	20%	16	0.65	CX 0603 MR X7R 7BB 473
	56	20%	16	0.65	CX 0603 MR X7R 7BB 563
	100	20%	10	0.65	CX 0603 MR X7R 6BB 104
	180	20%	10	0.65	CX 0603 MR X7R 6BB 184
	220	20%	10	0.65	CX 0603 MR X7R 6BB 224
270	20%	10	0.65	CX 0603 MR X7R 6BB 274	
330	20%	10	0.65	CX 0603 MR X7R 6BB 334	
0805	1	20%	100	0.85	CX 0805 MR X7R 0BB 102
	1.5	20%	100	0.85	CX 0805 MR X7R 0BB 152
	2.2	20%	100	0.85	CX 0805 MR X7R 0BB 222
	4.7	20%	100	0.85	CX 0805 MR X7R 0BB 472
	5.6	20%	100	0.85	CX 0805 MR X7R 0BB 562
	10	20%	100	0.85	CX 0805 MR X7R 0BB 103
	15	20%	50 / 63	0.85	CX 0805 MR X7R 9BB 153
	18	20%	50 / 63	0.85	CX 0805 MR X7R 9BB 183
	22	20%	50 / 63	0.85	CX 0805 MR X7R 9BB 223
	47	20%	16	0.85	CX 0805 MR X7R 7BB 473
	56	20%	16	0.85	CX 0805 MR X7R 7BB 563
	100	20%	16	0.85	CX 0805 MR X7R 7BB 104
	180	20%	10	0.85	CX 0805 MR X7R 6BB 184
	1206	10	20%	100	1.2
15		20%	100	1.2	CX 1206 MK X7R 0BB 153
18		20%	100	1.2	CX 1206 MK X7R 0BB 183
22		20%	100	1.2	CX 1206 MK X7R 0BB 223
33		20%	100	1.2	CX 1206 MK X7R 0BB 333
39		20%	50 / 63	1.2	CX 1206 MK X7R 9BB 393
47		20%	50 / 63	1.2	CX 1206 MK X7R 9BB 473
56		20%	50 / 63	1.2	CX 1206 MK X7R 9BB 563
100		20%	50 / 63	1.2	CX 1206 MK X7R 9BB 104
180		20%	16	1.2	CX 1206 MK X7R 7BB 184
220		20%	16	1.2	CX 1206 MK X7R 7BB 224
270		20%	16	1.2	CX 1206 MK X7R 7BB 274
330		20%	16	1.2	CX 1206 MK X7R 7BB 334
390		20%	16	1.2	CX 1206 MK X7R 7BB 394
470		20%	10	1.2	CX 1206 MK X7R 6BB 474
1210	100	20%	50	1.6	CX1210MKX7R9BB104
	180	20%	50	1.6	CX1210MKX7R9BB184
	220	20%	50	1.6	CX1210MKX7R9BB224
	270	20%	50	1.6	CX1210MKX7R9BB274
	330	20%	50	1.6	CX1210MKX7R9BB334
	390	20%	50	1.6	CX1210MKX7R9BB394
	470	20%	50	1.6	CX1210MKX7R9BB474
	560	20%	50	1.6	CX1210MKX7R9BB564
	820	20%	16	1.6	CX1210MKX7R7BB824
1000	20%	16	1.6	CX1210MKX7R7BB105	



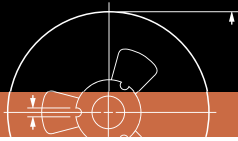

X2Y® Product Selection Charts

Ordering information

X5R					
Size	Y-Capacitor		Voltage rating (V)	Thickness (mm)	Global part number
	Capacitance (nF)	Tolerance (%)			
0603	180	20%	10	0.65	CX 0603 MR X5R 6BB 184
	220	20%	10	0.65	CX 0603 MR X5R 6BB 224
	330	20%	10	0.65	CX 0603 MR X5R 6BB 334
	390	20%	10	0.65	CX 0603 MR X5R 6BB 394
	470	20%	10	0.65	CX 0603 MR X5R 6BB 474

Thickness classes and packing quantities			
Thickness Classification (mm)	Quantity per reel		
	8 mm tape width		
	Ø180mm / 7"		
	0603 - 1410		
	Paper	Blister	
0.60 ±0.10	4 000	---	
0.85 ±0.10	4 000	---	
1.20 ±0.15	---	3 000	
1.60 ±0.15	---	2 000	
1.90 ±0.20	---	2 000	

Note: 1. Special values are available on request

Global part number	
Ordering example: CX0603MKX7R6BB104	
<p>X 0603 M K X7R 6 B B 104</p>	
Series name (code 1-2) CX = X2Y®-series	Capacitance value (code 15-17) 104 = 100 000 pF (2 significant digits+number of zeros; the 3rd digit signifies the multiplying factor, and letter R is decimal point) 0 = x 1 1 = x 10 ¹ 2 = x 10 ² 3 = x 10 ³ 4 = x 10 ⁴ 5 = x 10 ⁵ 6 = x 10 ⁶
Size code (code 3-6) EIA mm 0603 (1608M) 0805 (2012M) 1206 (3216M) 1210 (3225M) 1410 (3625M)	Process code (code 14) B = BME
Capacitance tolerance (code 7) M = ±20%	Termination (code 13) B = Ni-barrier
Packing style (code 8) R = Paper tape reel Ø7" K = Embossed plastic tape reel Ø7"	Rated voltage (code 12) 5 = 6.3 V 6 = 10 V 7 = 16 V 8 = 25 V 9 = 50 V 0 = 100 V
TC material (code 9-11) NPO X7R X5R	



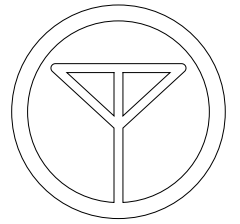

WIRELESS COMPONENTS

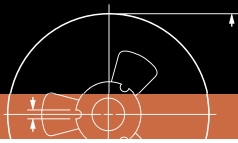

Wireless Components Product Selection Charts

Introduction

Introduction

Yageo produces a comprehensive range of wireless components, including metal/PCB/FPCB antenna, patch antenna (ceramic bulk), active antenna (LNA circuit), chip antenna, and RF components (filter/balancer).





Our products cover a wide variety of wireless communication protocols, including Bluetooth & IEEE 802.11b/g, WPAN (Wireless Personal Area Network), WLAN (Wireless Local Area Network), WMAN (Wireless Metropolitan Area Network), WWAN (Wireless Wide Area Network) and LTE (Long Term Evolution).

Wireless Components

Antenna

				
Metal	PCB	FPCB	LTCC / Ceramic	Patch / Ceramic

LTCC Balun/ Filter/ Balun + Filter (Combo) / Coupler

				
Balun	Filter	Diplexer	Balanced Filter	Coupler

Yageo Antenna Portfolio

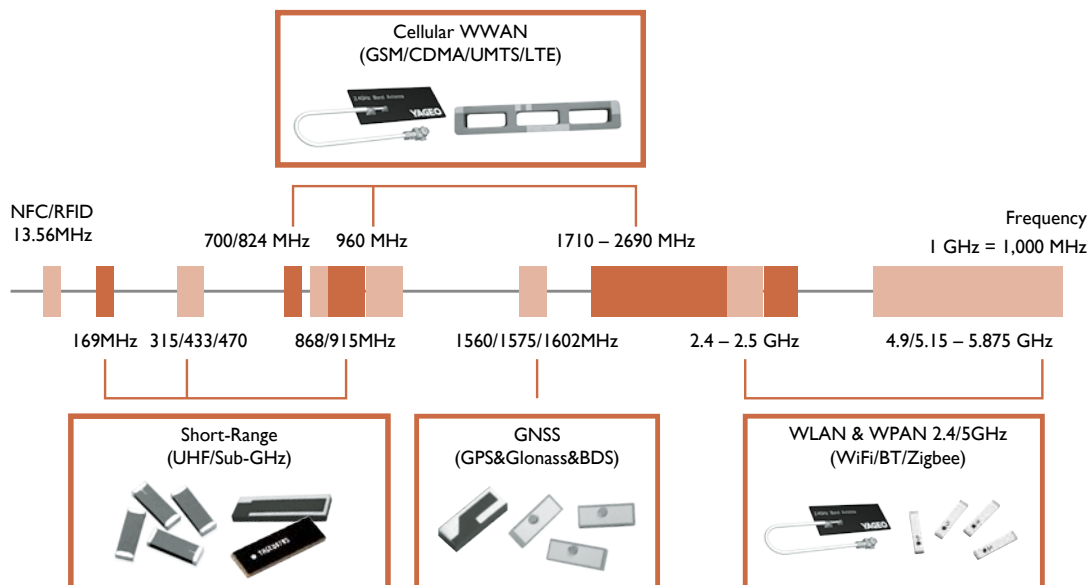

Portable devices, home appliances, industrial/medical equipment will be equipped with wireless connectivity for Peer-to-Peer data exchange. More wireless components are needed.

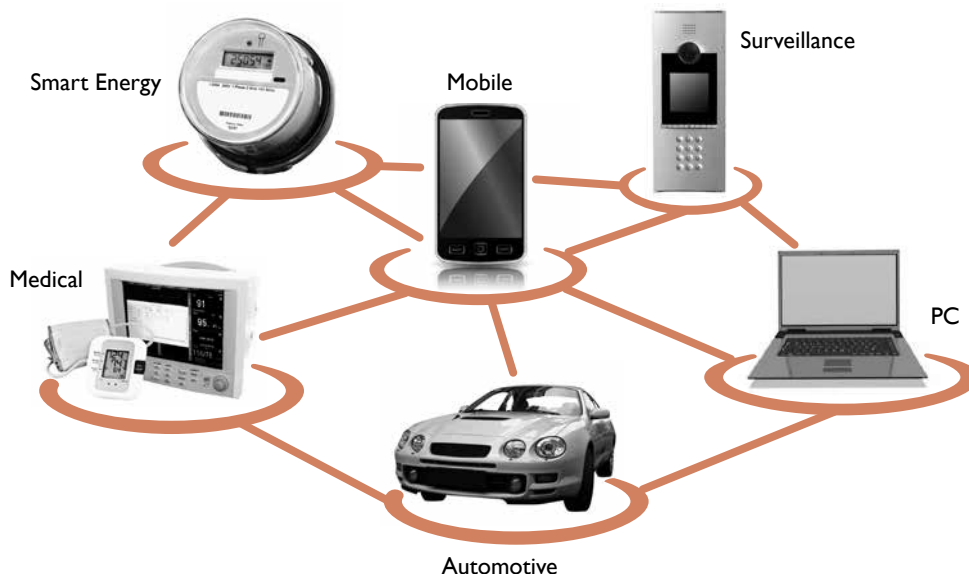

Key features of wireless components

Compact

- Maximize performance with the smallest size required
- The smallest 2.4/5 GHz antenna: PCB 18.4x7.5 mm / LTCC 1.0x0.5 mm

Multi-Band & High Efficiency

- WWAN: Quad-band (850/900/1800/1900 MHz) to Penta-band (850/900/1800/1900/2100 MHz)
- Support 4G cellular network LTE 700 MHz (Band 12,13,17), 2300/2600 MHz
- Multi-band 2.3/2.4/2.7 & 5 GHz supporting WLAN/WiMAX/LTE
- Operating in navigational systems Beidou, GPS & Glonass: 1561 - 1606 MHz

High Reliability

- Operating temperature range: -40°C ~ 105°C
- Operating humidity 95% RH at 40°C
- Vibration verification

Easy Installation

- Reliable adhesive tape, surface mount, and flexible cable/connector selection

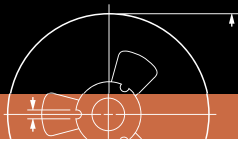

Wireless Components Selection Charts

Antenna - 2.4 GHz

2.4 GHz

Model	Part No./ Description	Electrical Data	Mechanical Data
	ANT1204F001R2400A 1204 2.4GHz PIFA Chip Ante	Freq. Range: 2400~2500 MHz VSWR*: 2.0 (Max) Polarization: Linear Peak Gain : 6.66 dBi (Typ.)	Size (mm) : 12*4*2.0 Operating Temp.: -40 ~ 105°C RoHS Compliance
	ANT9520LL06R2400A 9520 2.4GHz Chip Antenna	Freq. Range: 2400~2500 MHz VSWR*: 2.5 (Max) Polarization: Linear Peak Gain : 2.85 dBi (Typ.)	Size (mm) : 9.5*2.0*1.2 Operating Temp.: -40 ~ 105°C RoHS Compliance
	ANT8010LL04R2400A 8010 2.4GHz Chip Antenna	Freq. Range: 2400~2500 MHz VSWR*: 2.0 (Max) Polarization: Linear Peak Gain : 5.88 dBi (Typ.)	Size (mm) : 8.0*1.0*1.0 Operating Temp.: -40 ~ 105°C RoHS Compliance
	ANT7836A003R2400A 7836 2.4GHz Chip Antenna	Freq. Range: 2400~2500 MHz VSWR*: 2.0 (Max) Polarization: Linear Peak Gain : 3.93 dBi (Typ.)	Size (mm) : 7.8*3.6*0.5 Operating Temp.: -40 ~ 105°C RoHS Compliance
	ANT7020LL05R2400A 7020 2.4GHz Chip Antenna	Freq. Range: 2400~2500 MHz VSWR*: 2.8 (Max) Polarization: Linear Peak Gain : 2.62 dBi (Typ.)	Size (mm) : 7.0*2.0*0.8 Operating Temp.: -40 ~ 105°C RoHS Compliance
	ANT5320LL45R2400A 5320 2.4GHz Chip Antenna	Freq. Range: 2400~2500 MHz VSWR*: 2.0 (Max) Polarization: Linear Peak Gain : 5.5 dBi (Typ.)	Size (mm) : 5.3*2.0*1.2 Operating Temp.: -40 ~ 105°C RoHS Compliance
	ANT5320LL24R2400A 5320 2.4GHz PIFA Chip Antenna	Freq. Range: 2400~2500 MHz VSWR*: 2.0 (Max) Polarization: Linear Peak Gain : 2.78 dBi (Typ.)	Size (mm) : 5.3*2.0*1.25 Operating Temp.: -40 ~ 105°C RoHS Compliance
	ANT5010LL04R2400A 5010 2.4GHz Chip Antenna	Freq. Range: 2400~2500 MHz VSWR*: 2.8 (Max) Polarization: Linear Peak Gain : 2.28 dBi (Typ.)	Size (mm) : 5.0*1.0*1.0 Operating Temp.: -40 ~ 105°C RoHS Compliance
	ANT3216LL00R2400A 3216 2.4Ghz Chip Antenna	Freq. Range: 2400~2500 MHz VSWR*: 2.5 (Max) Polarization: Linear Peak Gain : 5 dBi (Typ.)	Size (mm) : 3.2*1.6*1.3 Operating Temp.: -40 ~ 105°C RoHS Compliance
	ANT3216LL11R2400A 3216 2.4GHz PIFA Chip Antenna	Freq. Range: 2400~2500 MHz VSWR*: 2.8 (Max) Polarization: Linear Peak Gain : 3.68 dBi (Typ.)	Size (mm) : 3.2*1.6*1.2 Operating Temp.: -40 ~ 105°C RoHS Compliance
	ANT2012LL13R2400A 2012 2.4GHz PIFA Chip Antenna	Freq. Range : 2400~2500 MHz VSWR*: 2.0 (Max) Polarization: Linear Peak Gain : 2.72 dBi (Typ.)	Size (mm) : 2.0*1.2*1.0 Operating Temp.: -40 ~ 105°C RoHS Compliance
	ANT1608LL14R2400A 1608 2.4GHz PIFA Chip Antenna	Freq. Range : 2400~2500 MHz VSWR*: 3.0 (Max) Polarization: Linear Peak Gain : 2.0 dBi (Typ.)	Size (mm) : 1.6*0.8*0.4 Operating Temp.: -40 ~ 105°C RoHS Compliance



* VSWR depends on the environment





Wireless Components Selection Charts

Antenna - 2.4 GHz, 2.4 GHz / GPS, 2.4 / 5 GHz

2.4 GHz

Model	Part No./ Description	Electrical Data	Mechanical Data
	ANTI005LLI4R2400A 1005 2.4G PIFA Chip Antenna	Freq. Range : 2400~2484 MHz VSWR* : 3.0 (Max) Polarization : Linear Peak Gain : 2.21 dBi (Typ.)	Size (mm) : 1.0*0.5*0.37 Operating Temp. : -40 ~ 105°C RoHS Compliance
	ANTX200P001B24003 2.4GHz PCB Antenna - mini	Freq. Range : 2400 MHz VSWR* : 2.5 (Max) Polarization : Linear Peak Gain : 4.8 dBi (Typ.)	Size (mm) : 18.4*7.5*0.55 Operating Temp. : -40 ~ 80°C RoHS Compliance

2.4 GHz / GPS

Model	Part No./ Description	Electrical Data	Mechanical Data
	ANTI003LLI5R1524A 1003 2.4GHz+GPS PIFA Chip Antenna	Freq. Range : 1575 / 2400 MHz VSWR* : 2.8 (Max) Polarization : Linear Peak Gain : 1.15 dBi / 2.90 dBi (Typ.)	Size (mm) : 10*3*1.5 Operating Temp. : -40 ~ 105°C RoHS Compliance
	ANT5320LL07R1524A / 5320 2.4GHz+GPS PIFA Chip Antenna	Freq. Range : 1575 / 2400 MHz VSWR* : 2.0 (Max) Polarization : Linear Peak Gain : 2.47 dBi / 2.04 dBi (Typ.)	Size (mm) : 5.3*2.0*1.2 Operating Temp. : -40 ~ 105°C RoHS Compliance

2.4 / 5 GHz

Model	Part No./ Description	Electrical Data	Mechanical Data
	ANTI003LLI5R2455A 1003 2.4+5GHz Chip Antenna	Freq. Range : 2400~2500/ 5150~5875 MHz VSWR* : 2.8 (Max) Polarization : Linear Peak Gain : 2.45 dBi / 1.55dBi (Typ.)	Size (mm) : 10*3*1.6 Operating Temp. : -40 ~ 105°C RoHS Compliance
	ANT5320LL04R2455A 5320 2.4+5GHz Chip Antenna	Freq. Range : 2400~2500/ 5150~5875 MHz VSWR* : 2.8 (Max) Polarization : Linear Peak Gain : 2.72 dBi / 3.85 dBi (Typ.)	Size (mm) : 5.3*2.0*1.4 Operating Temp. : -40 ~ 105°C RoHS Compliance
	ANT5320LL24R2455A 5320 2.4+5GHz PIFA Chip Antenna	Freq. Range : 2400~2500/ 5150~5875 MHz VSWR* : 2.8 (Max) Polarization : Linear Peak Gain : 2.17 dBi / 3.51 dBi (Typ.)	Size (mm) : 5.3*2.0*1.2 Operating Temp. : -40 ~ 105°C RoHS Compliance
	ANT3216LLI1R2455A 3216 2.4+5GHz PIFA Chip Antenna	Freq. Range : 2400 - 2500/5150 - 5875 MHz VSWR* : 2.8 (Max) Polarization : Linear Peak Gain : 0.45/0.64 dBi (Typ.)	Size (mm) : 3.2*1.6*1.2 Operating Temp. : -40 ~ 105°C RoHS Compliance
	ANTI608LLI4R2455A 1608 2.4+5GHz Chip Antenna	Freq. Range : 2400 - 2500/5150 - 5875 MHz VSWR* : 6/3.5 (Max) Polarization : Linear Peak Gain : 3.11 / 3.43 dBi (Typ.)	Size (mm) : 1.6*0.8*0.4 Operating Temp. : -40~105°C RoHS Compliance
	ANTX200P002B24553 2.4+5GHz PCB Antenna	Freq. Range : 2400 - 2500/5150 - 5875MHz VSWR* : 2.5 (Max) Polarization : Linear Peak Gain : 2.3 dBi (Typ.)	Size (mm) : 40*43*0.55 Operating Temp. : -40 ~ 105°C RoHS Compliance
	ANTX100P001B24553 2.4+5GHz PCB Antenna	Freq. Range : 2400~2500/ 5150~5875 MHz VSWR* : 2.5 (Max) Polarization : Linear Peak Gain : 5.1 dBi (Typ.)	Size (mm) : 50*10*0.9 Operating Temp. : -40 ~ 80°C RoHS Compliance

* VSWR depends on the environment



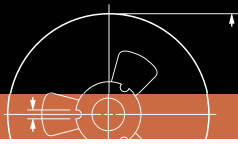

Wireless Components Product Selection Charts

Antenna - 5 GHz, Cellular WWAN, Short Range

5 GHz



Model	Part No./ Description	Electrical Data	Mechanical Data
	ANT3216LL05R5000A 3216 5GHz Chip Antenna	Freq. Range : 5150~5875 MHz VSWR* : 2.0 (Max) Polarization : Linear Peak Gain : 5.71 dBi (Typ.)	Size (mm) : 3.2*1.6*1.3 Operating Temp. : -40 ~ 105°C RoHS Compliance

* VSWR depends on the environment

Cellular WWAN

Model	Part No./ Description	Electrical Data	Mechanical Data
	ANT2112A010B0918A 2112 Cellular-Band Chip Antenna	Freq. Range : 824~960 / 1710~1990 MHz VSWR* : 2.0 (Max) Polarization : Linear Peak Gain : 0.5 ~ 1 dBi (Typ.)	Size (mm) : 21*12*0.5 Operating Temp. : -40 ~ 105°C RoHS Compliance
	ANT1204LL00R0918A 1204 Cellular-Band Chip Antenna	Freq. Range : 900/1800 MHz VSWR* : 3.0 (Max) Polarization : Linear Peak Gain : N/A	Size (mm) : 12*4*1.2 Operating Temp. : -40 ~ 105°C RoHS Compliance
	ANT3505B002TVPENS 3505 Penta-band Antenna	Freq. Range : 824~960 / 1710~2170 MHz VSWR* : 2.8 / 3.5 (Max) Polarization : Linear Peak Gain : 2.9 dBi (Typ.)	Size (mm) : 35*5*6 Operating Temp. : -40 ~ 105°C RoHS Compliance
	ANTX100P001BWPEN3 Penta-band PCB Antenna	Freq. Range : 824~960 / 1710~2170 MHz VSWR* 2.5 Max (Low Band) 3.5 Max (High Band) Polarization : Linear Peak Gain : 4.2 dBi (Typ.)	Size (mm) : 50*20*0.55 Operating Temp. : -40 ~ 80°C Cable* : Φ1.13 / 100mm Connector : I-PEX Mounting : Adhesive Tape RoHS Compliance
	ANT4005B000RWHEXS 4005 LTE Antenna	Freq. Range : 698 - 960/1710 - 2690 MHz VSWR* : 3.0 Max (Low Band) Polarization : Linear Peak Gain : 3.2 / 4.0 dBi (Typ.)	Size (mm) : 40*5*6 Operating Temp. : -40 ~ 80°C RoHS Compliance
	ANTX100PI20BUNVS3 Universal PCB Antenna	Freq. Range : 700~6000 MHz VSWR* : Polarization : Linear Peak Gain : 4.14 dBi (Typ.)	Size (mm) : 90*20*0.55 Operating Temp. : -40 ~ 105°C RoHS Compliance
	ANT4005B000RUNVSS 4005 Universal Antenna	Freq. Range : 700~6000 MHz VSWR* : Polarization : Linear Peak Gain : 1.46 / 2.89 / 1.81 dBi (Typ.)	Size (mm) : 40*5*6 Operating Temp. : -40 ~ 105°C RoHS Compliance

Short-Range

Model	Part No./ Description	Electrical Data	Mechanical Data
	ANT1204LL05R0915A 1204 915MHz Chip Antenna	Freq. Range : 915 MHz VSWR* : 2.0 (Max) Polarization : Linear Peak Gain : 3.32 dBi (Typ.)	Size (mm) : 12*4*1.6 Operating Temp. : -40 ~ 105°C RoHS Compliance
	ANT1204F005R0915A 1204 915MHz Chip Antenna	Freq. Range : 915 MHz VSWR* : 2.0 (Max) Polarization : Linear Peak Gain : 1.59 dBi (Typ.)	Size (mm) : 12*4*1.6 Operating Temp. : -40 ~ 85°C RoHS Compliance

* VSWR depends on the environment



Wireless Components Selection Charts

Antenna - Short-Range, GPS

Short-Range			
Model	Part No./ Description	Electrical Data	Mechanical Data
	ANT1204LL08R0870A 1204 870MHz Chip Antenna	Freq. Range : 870 MHz VSWR*: 2.0 (Max) Polarization: Linear Peak Gain : 0.5 dBi (Typ.)	Size (mm) : 12*4*1.6 Operating Temp.: -40 ~ 105°C RoHS Compliance
	ANT1204LL16R0870A 1204 870MHz PIFA Chip Antenna	Freq. Range : 870 MHz VSWR*: 2.8 (Max) Polarization: Linear Peak Gain : 1.05 dBi (Typ.)	Size (mm) : 12*4*1.0 Operating Temp.: -40 ~ 105°C RoHS Compliance
	ANT1204F007R0870A 1204 870MHz Chip Antenna	Freq. Range : 870 MHz VSWR*: 2.0 (Max) Polarization: Linear Peak Gain : 1.67 dBi (Typ.)	Size (mm) : 12*4*1.6 Operating Temp.: -40 ~ 85°C RoHS Compliance
	ANT7020LL05R0870A 7020 870MHz Chip Antenna	Freq. Range : 870 MHz VSWR*: 2.0 (Max) Polarization: Linear Peak Gain : N/A	Size (mm) : 7.0*2.0*0.7 Operating Temp.: -40 ~ 105°C RoHS Compliance
	ANT1204LL20R0433A 1204 433MHz Chip Antenna	Freq. Range : 315/ 433 MHz VSWR*: 3.0 (Max) Polarization: Linear Peak Gain : 0.83 dBi (Typ.)	Size (mm) : 12*4*1.2 Operating Temp.: -40 ~ 105°C RoHS Compliance
	ANT1204F002R0433A 1204 433MHz Chip Antenna	Freq. Range : 315/ 433 MHz VSWR*: 2.0 (Max) Polarization: Linear Peak Gain : 0.79 dBi (Typ.)	Size (mm) : 12*4*1.6 Operating Temp.: -40 ~ 105°C RoHS Compliance
	ANT2405F001R0169A 2405 169MHz Chip Antenna	Freq. Range : 169 MHz VSWR*: 2.0 (Max) Polarization: Linear Peak Gain : N/A	Size (mm) : 24*5*1.6 Operating Temp.: -40 ~ 105°C RoHS Compliance
GPS			
Model	Part No./ Description	Electrical Data	Mechanical Data
	ANT8010LL05R1575A 8010 GPS Chip Antenna	Freq. Range : 1575 MHz VSWR*: 2.0 (Max) Polarization: Linear Peak Gain : 0.67 dBi (Typ.)	Size (mm) : 8.0*1.0*1.0 Operating Temp.: -40 ~ 105°C RoHS Compliance
	ANT5320LL14R1575A 5320 GPS PIFA Chip Antenna	Freq. Range : 1575 MHz VSWR*: 2.0 (Max) Polarization: Linear Peak Gain : 3.16 dBi (Typ.)	Size (mm) : 5.3*2.0*1.2 Operating Temp.: -40 ~ 105°C RoHS Compliance
	ANT3216LL15R1575A 3216 GPS PIFA Chip Antenna	Freq. Range : 1575 MHz VSWR*: 2.0 (Max) Polarization: Linear Peak Gain : 7.32 dBi (Typ.)	Size (mm) : 3.2*1.6*1.2 Operating Temp.: -40 ~ 105°C RoHS Compliance
	ANT1010B00FT1575S 10104 GPS Patch Antenna	Freq. Range : 1575 MHz VSWR*: 2.0 (Max) Polarization: RHCP Peak Gain : -3 dBic(Typ.)	Size (mm) : 10*10*4 Operating Temp.: -40 ~ 105°C Mounting: PIN RoHS Compliance

* VSWR depends on the environment



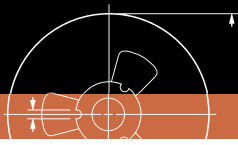











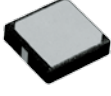

Wireless Components Selection Charts

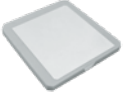
Antenna - GPS

GPS

Model	Part No./ Description	Electrical Data	Mechanical Data
	ANT1212B00DT1575S 12124 GPS Patch Antenna	Freq. Range : 1575 MHz VSWR*: 2.0 (Max) Polarization: RHCP Peak Gain: -1 dBic(Typ.)	Size (mm): 12*12*4 Operating Temp.: -40 ~ 105°C Mounting: PIN RoHS Compliance
	ANT1515B00DT1575S 15154 GPS Patch Antenna	Freq. Range : 1575 MHz VSWR*: 2.0 (Max) Polarization: RHCP Peak Gain: 1.5 dBic(Typ.)	Size (mm): 15*15*4 Operating Temp.: -40 ~ 105°C Mounting: PIN RoHS Compliance
	ANT1515B00FT1575S 15154 GPS Patch Ant	Freq. Range : 1575 MHz VSWR*: 2.0 (Max) Polarization: RHCP Peak Gain: 2.0 dBic(Typ.)	Size (mm): 15*15*4 Operating Temp.: -40 ~ 105°C Mounting: PIN RoHS Compliance
	ANT1818B00AT1575S 18182 GPS Patch Antenna	Freq. Range : 1575 MHz VSWR*: 2.0 (Max) Polarization: RHCP Peak Gain: 2 dBic(Typ.)	Size (mm): 18*18*2 Operating Temp.: -40 ~ 105°C Mounting: SMD RoHS Compliance
	ANT1818B00BT1575S 18184 GPS Patch Antenna	Freq. Range : 1575 MHz VSWR*: 2.0 (Max) Polarization: RHCP Peak Gain: 2 dBic(Typ.)	Size (mm): 18*18*4 Operating Temp.: -40 ~ 105°C Mounting: SMD RoHS Compliance
	ANT1818B00CT1575S 18182 GPS Patch Antenna	Freq. Range: 1575 MHz VSWR*: 2.0 (Max) Polarization: RHCP Peak Gain: 2 dBic(Typ.)	Size (mm): 18*18*2 Operating Temp. : -40 ~ 105°C Mounting: PIN RoHS Compliance
	ANT1818B00DT1575S 18184 GPS Patch Antenna	Freq. Range: 1575 MHz VSWR*: 2.0 (Max) Polarization: RHCP Peak Gain: 4 dBic(Typ.)	Size (mm): 18*18*4 Operating Temp. : -40 ~ 105°C Mounting: PIN RoHS Compliance
	ANT1818B00ET1575S 18182 GPS Patch Antenna	Freq. Range: 1575 MHz VSWR*: 2.0 (Max) Polarization: RHCP Peak Gain: 2 dBic(Typ.)	Size (mm): 18*18*2 Operating Temp. : -40 ~ 105°C Mounting: PIN RoHS Compliance
	ANT2525B00AT1575S 25252 GPS Patch Antenna	Freq. Range: 1575 MHz VSWR*: 2.0 (Max) Polarization: RHCP Peak Gain: 5 dBic(Typ.)	Size (mm): 25*25*2 Operating Temp. : -40 ~ 105°C Mounting: SMD RoHS Compliance
	ANT2525B00BT1575S 25254 GPS Patch Antenna	Freq. Range: 1575 MHz VSWR*: 2.0 (Max) Polarization: RHCP Peak Gain: 5.5 dBic(Typ.)	Size (mm): 25*25*4 Operating Temp. : -40 ~ 105°C Mounting: SMD RoHS Compliance
	ANT2525B00CT1575S 25252 GPS Patch Antenna	Freq. Range: 1575 MHz VSWR*: 2.0 (Max) Polarization: RHCP Peak Gain: 4.5 dBic(Typ.)	Size (mm): 25*25*2 Operating Temp. : -40 ~ 105°C Mounting: PIN RoHS Compliance
	ANT2525B00DT1575S 25254 GPS Patch Antenna	Freq. Range: 1575 MHz VSWR*: 2.0 (Max) Polarization: RHCP Peak Gain: 5 dBic(Typ.)	Size (mm): 25*25*4 Operating Temp. : -40 ~ 105°C Mounting: PIN RoHS Compliance



* VSWR depends on the environment



Wireless Components Selection Charts





Antenna - GPS, GPS + Glonass, GNSS

GPS

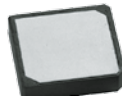

Model	Part No./ Description	Electrical Data	Mechanical Data
	ANT2525B00ET1575S 25252 GPS Patch Antenna	Freq. Range: 1575 MHz VSWR*: 2.0 (Max) Polarization: RHCP Peak Gain: 4.5 dBic(Typ.)	Size (mm): 25*25*2 Operating Temp.: -40 ~ 105°C Mounting: PIN RoHS Compliance
	ANT2525B00FT1575S 25254 GPS Patch Antenna	Freq. Range: 1575 MHz VSWR*: 2.0 (Max) Polarization: RHCP Peak Gain: 5 dBic(Typ.)	Size (mm): 25*25*4 Operating Temp.: -40 ~ 105°C Mounting: PIN RoHS Compliance
	ANT1606B00DT1575S 16064 GPS Patch Antenna	Freq. Range: 1575 MHz VSWR*: 2.0 (Max) Polarization: Linear Peak Gain: -0.5 dBic(Typ.)	Size (mm): 16*6*4 Operating Temp.: -40 ~ 105°C Mounting: PIN RoHS Compliance

* VSWR depends on the environment

GPS+Glonass

Model	Part No./ Description	Electrical Data	Mechanical Data
	ANT8010LL05R1516A 8010 GPS+Glonass Chip Antenna	Freq. Range : 1575 / 1602 MHz VSWR* : 2.0 (Max) Polarization: Linear Peak Gain: 1.53 / 1.69 dBi (Typ.)	Size (mm): 8.0*1.0*1.0 Operating Temp.: -40 ~ 105°C RoHS Compliance
	ANT1818B00BT1516S 18184 Gps+Glonass Patch Antenna	Freq. Range: 1575 / 1602 MHz VSWR*: 2.0 (Max) Polarization: Linear Peak Gain: 1.89 / 2.59 dBi (Typ.)	Size (mm): 18*18*4 Operating Temp.: -40 ~ 105°C Mounting: SMD RoHS Compliance
	ANT1818B00DT1516S 18184 Gps+Glonass Patch Antenna	Freq. Range: 1575 / 1602 MHz VSWR*: 2.0 (Max) Polarization: Linear Peak Gain: 2.65 / 2.79 dBi (Typ.)	Size (mm): 18*18*4 Operating Temp.: -40 ~ 105°C Mounting: PIN RoHS Compliance
	ANT2525B00BT1516S 25254 Gps+Glonass Patch Antenna	Freq. Range: 1575 / 1602 MHz VSWR*: 2.0 (Max) Polarization: Linear Peak Gain: 3.44 / 4.10 dBi (Typ.)	Size (mm): 25*25*4 Operating Temp.: -40 ~ 105°C Mounting: SMD RoHS Compliance
	ANT2525B00DT1516S 25254 Gps+Glonass Patch Antenna	Freq. Range: 1575 / 1602 MHz VSWR*: 2.0 (Max) Polarization: Linear Peak Gain: 3.5 / 3.8 dBi (Typ.)	Size (mm): 25*25*4 Operating Temp.: -40 ~ 105°C Mounting: PIN RoHS Compliance

GNSS

Model	Part No./ Description	Electrical Data	Mechanical Data
	ANT1204LL04RGNSSA 1204 GNSS Chip Antenna	Freq. Range : 1559 - 1610 MHz VSWR*: 2.0 (Max) Polarization: RHCP Peak Gain : 2.32 dBic (Typ.)	Size (mm): 12*4*1.1 Operating Temp.: -40 ~ 105°C RoHS Compliance
	ANT2525B00FTGNSSS 25254 GNSS Patch Antenna	Freq. Range : 1559 - 1610 MHz VSWR*: 2.0 (Max) Polarization: RHCP Peak Gain : 5.16 dBic (Typ.)	Size (mm): 25*25*4 Operating Temp.: -40 ~ 105°C Mounting: PIN RoHS Compliance

* VSWR depends on the environment



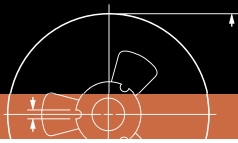



Wireless Components Selection Charts

Antenna - GNSS, GPS L1 + L5, GNSS + L2&L5, Active GPS / GPS + Glonass / L1 + L5

GNSS

Model	Part No./ Description	Electrical Data	Mechanical Data
	ANT1818B00FTGNSSS 18184 GNSS Patch Antenna	Freq. Range : 1559 - 1610 MHz VSWR*: 3.5 (Max) Polarization: RHCP Peak Gain : 3 dBiC (Typ.)	Size (mm): 18*18*4 Operating Temp.: -40 ~ 105°C Mounting: PIN RoHS Compliance
	ANT2525B00TTGNSSS 25256 GNSS Patch Antenna	Freq. Range : 1559 - 1610 MHz VSWR*: 2.0 (Max) Polarization: RHCP Peak Gain: 5.0 dBi (Typ.)	Size (mm): 25*25*6 Operating Temp.: -40 ~ 105°C Mounting: PIN RoHS Compliance

GPS L1+L5

Model	Part No./ Description	Electrical Data	Mechanical Data
	ANT2525B00XTL1L5S 25254 + 35354 GPS L1+L5 Stack Antenna	Freq. Range : 1176 & 1575Mhz VSWR*: 2.0 (Max) Polarization: RHCP Peak Gain: L5: 2.7 / L2: 4.7 dBi (Typ.)	Size (mm): 25*25*4 + 35*35*4 Operating Temp.: -40 ~ 105°C Mounting: PIN RoHS Compliance

GNSS+L2&L5

Model	Part No./ Description	Electrical Data	Mechanical Data
	ANT4050BS0WTGN25S 40404 + 50508 GNSS+GPS L2&L5 Stack Antenna	Freq. Range : 1176/1227 & 1559-1610Mhz VSWR*: 2.0 (Max) Polarization: RHCP Antenna Gain: L5:1.34 / L2:0.56 /GNSS : 4.73 dBi(Typ.)	Size (mm): 40*40*4 + 50*50*8 Operating Temp.: -40 ~ 105°C RoHS Compliance

Active GPS

Model	Part No./ Description	Electrical Data	Mechanical Data
	ANT2525JB08B1575A 25256.9 GPS Active Antenna	Freq. Range: 1575 MHz VSWR*: 2.0 (Max) Polarization: RHCP LNA Gain: 16 dB (Typ.) Antenna Gain: 5.5 dBic(Typ.)	Size (mm): 25*25*6.9 Cable* (mm): 1.13*75 Operating Temp. : -30 ~ 85°C RoHS Compliance

Active GPS+Glonass

Model	Part No./ Description	Electrical Data	Mechanical Data
	ANT8010JLC1B1516A 22061.9 GPS+Glonass Active Antenna	Freq. Range: 1575/1602 MHz VSWR*: 2.0 (Max) Polarization: Linear LNA Gain: 20 / 20 dB (Typ.) Antenna Gain: 5.88 dBi (Typ.)	Size (mm): 22*6*1.9 Cable* (mm): 1.13*100 Operating Temp. : -30 ~ 85°C RoHS Compliance

Active L1+L5

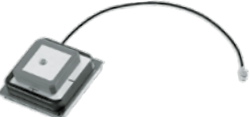
Model	Part No./ Description	Electrical Data	Mechanical Data
	ANT1825JB51BGNL5A 282812 GNSS+GPS L5 Active Antenna	Freq. Range : 1176 & 1559-1610Mhz VSWR*: 2.0 (Max) Polarization: RHCP LNA Gain: 38 dB (Typ.) Antenna Gain: L5: 2.51/ L1: 2.01 dBic (Typ.)	Size (mm): 28*28*12 Operating Temp.: -40 ~ 105°C Cable* (mm): 1.13 *100 RoHS Compliance

* VSWR depends on the environment



Wireless Components Selection Charts

Antenna - Active L1+L2, FM, SDARS, Filter (BPF)

Active L1+L2

Model	Part No./ Description	Electrical Data	Mechanical Data
	ANT1825JB01BGNL2A	Freq. Range : 1227 & 1559-1610MHz	Size (mm): 25*25*12
	252512 GNSS+GPS L2	VSWR*: 2.0 (Max)	Operating Temp.: -40 ~ 105°C
	Active Antenna	Polarization: RHCP	Cable* (mm): 1.13 *100
		LNA Gain: 38 dB (Typ.)	RoHS Compliance
		Antenna Gain: L2: 2.58/ L1:2.50 dBic (Typ.)	

FM





Model	Part No./ Description	Electrical Data	Mechanical Data
	ANT2405F001R0098A	Freq. Range : 88 MHz	Size (mm): 24*5*1.6
	2405 FM Chip Antenna	VSWR*: 2.0 (Max)	Operating Temp.: -40 ~ 105°C
		Polarization: Linear	RoHS Compliance
		Peak Gain : N/A	

SDARS

Model	Part No./ Description	Electrical Data	Mechanical Data
	ANT2020B00FT2300S	Freq. Range : 2320~2345 MHz	Size (mm): 20*20*4
	20204 SDARS Patch Antenna	VSWR*: 2.0 (Max)	Operating Temp.: -40 ~ 105°C
		Polarization: LHCP	Mounting: PIN
		Peak Gain : 6 dBic(Typ.)	RoHS Compliance

* VSWR depends on the environment

Filter (BPF)

Model	Part No./ Description	Electrical Data	Mechanical Data
	BPF2520LL03R2400A	Freq. Range: 2400-2500MHz	Size(mm): 2.5*2.0*0.95
	2520 2.4G BPF Type03	Insertion Loss: 1.5dB(Max)	Operating Temp.: -40~85°C
		VSWR*: 2.0dB(Max)	RoHS Compliance
		Attenuation	
	BPF2012LL03R2400A	Freq. Range: 2400-2500MHz	Size(mm): 2.0*1.25*1.0
	2012 2.4G BPF Type03	Insertion Loss: 2.3dB(Max)	Operating Temp.: -40~85°C
		VSWR*: 2.0dB(Max)	RoHS Compliance
		Attenuation	
	BPF1608LM02R2400A	Freq. Range: 2400-2500 MHz	Size(mm): 1.6*0.8*0.6
	1608 2.4G BPF Type02	Insertion Loss: 1.7 dB (Max)	Operating Temp.: -40~85°C
		VSWR*: 2.0 (Max)	RoHS Compliance
		Attenuation:	
	BPF1005LM03R2400A	Freq. Range: 2400-2500MHz	Size(mm): 1.0*0.5*0.35
	1005 2.4G BPF Type03, L.L.	Insertion Loss: 1.5dB(Max)	Operating Temp.: -40~85°C
		VSWR*: 2.0dB (Max)	RoHS Compliance
		Attenuation	
	BPF2012LL01R5000A	Freq. Range: 4900-5950 MHz	Size(mm): 2.0*1.2*1
	2012 5G BPF Type01	Insertion Loss: 1.5dB (Max)	Operating Temp.: -40~85°C
		VSWR*: 2.0 (Max)	RoHS Compliance
		Attenuation:	

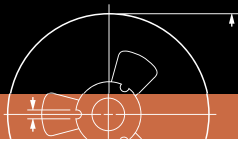









Wireless Components Selection Charts

Filter (BPF) / (LPF)

Filter (BPF)

Model	Part No./ Description	Electrical Data	Attenuation	Mechanical Data
	BPF1608LM08R5000A	Freq. Range: 4900~5840MHz	Attenuation	Size(mm): 1.6*0.8*0.6
	1608 5.0G BPF Type08	Insertion Loss: 1.5dB(Max) VSWR*: 2.0 (Max)	35dB Min @ 500~2170MHz 35dB Min @ 2170~2500MHz 30dB Min @ 9800~12000MHz	Operating Temp.: -40~85°C RoHS Compliance

Filter (LPF)



Model	Part No./ Description	Electrical Data	Attenuation	Mechanical Data
	LPF2012LM50R0433A	Freq. Range: 400-470MHz	Attenuation	Size(mm): 2.0*1.25*0.9
	2012 0.433Ghz LPF Type50	Insertion Loss: 0.5dB Max VSWR*: 2.0(Max)	33dB Min @ 800~940MHz	Operating Temp.: -40~85°C RoHS Compliance
	LPF1608LL55R0709A	Freq. Range: 698-960MHz	Attenuation	Size(mm): 1.6*0.8*0.6
	1608 LTE LPF Type55	Insertion Loss:	30dB Min @ 1554~1830MHz	Operating Temp.: -40~85°C
		0.6dB Max @ 698~830MHz	35dB Min @ 2097~2745MHz	RoHS Compliance
		0.7dB Max @ 830~900MHz		
	LPF1608LL60R0709A	Freq. Range: 698-960 MHz	Attenuation	Size(mm): 1.6*0.8*0.6
	1608 0.7-0.9GHz LPF Type60	Insertion Loss: 0.6(Max)	13dB Min @ 1554~1610MHz	Operating Temp.: -40~85°C
		VSWR*: 2.0dB(Max)	35dB Min @ 1805~1830MHz	RoHS Compliance
			35dB Min @ 2110~2170MHz 30dB Min @ 1710~2700MHz	
	LPF1608LL61R0780A	Freq. Range: 746-787 MHz	Attenuation	Size(mm): 1.6*0.8*0.6
	1608 787MHz LPF Type61	Insertion Loss: 0.6(Max) VSWR*: 2.0dB (Max)	30dB Min @ 1554~1610MHz 25dB Min @ 2238~2361MHz	Operating Temp.: -40~85°C RoHS Compliance
	LPF2012LM59RVPEA	Freq. Range: 800-2025 MHz	Attenuation	Size(mm): 2.0*1.25*0.9
	2012 LTE LPF Type59	Insertion Loss:	26dB Min @ 2300~6100MHz	Operating Temp.: -40~85°C
		0.5dB Max @ 800~1000MHz	35dB Min @ 3400~3820MHz	RoHS Compliance
		0.8dB Max @ 1700~1910MHz 1.5dB Max @ 2120~2025MHz VSWR*: 1.5 (Max)		
	LPF1608LL54RWHEXA	Freq. Range: 699-2690MHz	Attenuation:	Size(mm): 1.6*0.8*0.6
	1608 LTE LPF Type54	Insertion Loss: 0.25dB(Max) VSWR*: 1.5dB (Max)	23dB Min @ 5150~5960MHz	Operating Temp.: -40~85°C RoHS Compliance
	LPF1608LL56RWHEXA	Freq. Range: 600-2700MHz	Attenuation:	Size(mm): 1.6*0.8*0.65
	1608 LTE LPF Type56	Insertion Loss: 0.5dB(Max) VSWR*: 2.0dB (Max)	30dB Min @ 4800~8000MHz 25dB Min @ 8500~12500MHz	Operating Temp.: -40~85°C RoHS Compliance
	LPF1608LL57RWHEXA	Freq. Range: 600-2690MHz	Attenuation	Size(mm): 1.6*0.8*0.6
	1608 LTE-Hexa LPF Type57	Insertion Loss: 0.5dB(Max) VSWR*: 2.0dB(Max)	35dB Min@ 4950 ~ 6000MHz 30dB Min@ 6000 ~ 12500MHz	Operating Temp.: -40~85°C RoHS Compliance
	LPF1608LL62R1719A	Freq. Range: 1710-1910 MHz	Attenuation	Size(mm): 1.6*0.8*0.6
	1608 1.7-1.9GHz LPF Type62	Insertion Loss: 0.8(Max) VSWR*: 2.0dB(Max)	20dB Min @ 2400~2500MHz 25dB Min @ 3700~3820MHz	Operating Temp.: -40~85°C RoHS Compliance





* VSWR depends on the environment



Wireless Components Selection Charts

Filter (LPF) / (Diplexer)

Filter (LPF)				
Model	Part No./ Description	Electrical Data		Mechanical Data
	LPFI608LL53R2400A	Freq. Range: 2400-2500 MHz	Attenuation:	Size(mm): 1.6*0.8*0.65
	1608 2.4G LPF Type53	Insertion Loss: 0.48dB (Max)	35dB Min @ 4800~5000 MHz	Operating Temp.: -40~85°C
	LPFI005LL50R2400A	Freq. Range: 2400-2500MHz	Attenuation:	Size(mm): 1.0*0.5*0.35
	1005 2.4G LPF Type50	Insertion Loss: 0.5dB(Max)	25dB Min @ 4800~5000MHz	Operating Temp.: -40~85°C
	LPFI608LL52R2500A	Freq. Range: 2300-2700MHz	Attenuation:	Size(mm): 1.6*0.8*0.65
	1608 Wimax LPF Type52	Insertion Loss: 1.25dB(Max)	35dB Min @ 4800~5390MHz	Operating Temp.: -40~105°C
		VSWR*: 1.5 (Max)	27dB Min @ 7200~7500 MHz	RoHS Compliance
			20dB Min @ 7200~7500MHz	RoHS Compliance
			25dB Min @ 7200~8085MHz	RoHS Compliance

Filter (Diplexer)				
Model	Part No./ Description	Electrical Data		Mechanical Data
	DPX1608LM70R0917A	Freq. Range: 698-960MHz/ 1710-2700 MHz	Attenuation	Size(mm): 1.6*0.8*0.6
	1608 0.9/1.7GHz Diplexer Type70	Insertion Loss: Low: 0.8dB(Max) High: 0.7dB(Max)	Low Band: 25dB (Min).@1710~2700GHz	Operating Temp.: -40~85°C
	DPX1608LL88R1524A	Freq. Range: 1559-1610MHz/ 2400-2500 MHz/ 4900-6000 MHz	Attenuation	Size(mm): 1.68*0.8*0.6
	1608 1.575/2.4GHz Diplexer Type88	Insertion Loss: Low: 0.6dB(Typ) High Band: 0.7/ 0.6dB(Typ)	Low Band: 18dB(Min).@2400~2500MHz	Operating Temp.: -40~85°C
	DPX1608LL87R1524A	Freq. Range: 1570-1610MHz/ 2400-2500 MHz/4900-6000 MHz	Attenuation	Size(mm): 1.68*0.8*0.6
	1608 1.575/2.4GHz Diplexer Type87	Insertion Loss: Low: 0.6dB/ High: 0.7dB/0.6dB	Low Band: 15dB(Min) @2400~2500MHz	Operating Temp.: -40~85°C
	DPX1608LL76R1925A	Freq. Range: 1710-1880MHz/ 2500-2690 MHz	Attenuation	Size(mm): 1.6*0.8*0.6
	1608 1.9/2.5GHz Diplexer Type76	Insertion Loss: Low: 0.7dB(Max) High: 0.8dB(Max)	Low Band: 15dB (Min).@2500~2690MHz	Operating Temp.: -40~85°C
	DPX2012LL76R2455A	Freq. Range: 2400~2500MHz/ 4900~5950MHz	Attenuation	Size(mm): 2.0*1.25*0.5
	2012 2.4/5GHz Diplexer Type76	Insertion Loss: Low: 0.65dB(Max) High: 0.65dB(Max)	Low Band: 20dB(Min).@4800~5000MHz	Operating Temp.: -40~85°C
		VSWR*: 2.0 (Max)	20dB (Min).@7200~7500MHz	RoHS Compliance
			High Band: 20dB (Min).@824~915MHz	RoHS Compliance
			20dB (Min).@1800~2500MHz	RoHS Compliance
			15dB (Min).@9800~11900MHz	RoHS Compliance



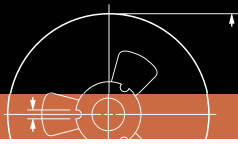

* VSWR depends on the environment



Wireless Components Selection Charts

Filter (Diplexer)

Filter (Diplexer)

Model	Part No./ Description	Electrical Data	Attenuation	Mechanical Data
	DPX2012LL75R2455A 2012 2.4/5GHz Diplexer Type75	Freq. Range: 2400~2500MHz/ 4900~5950MHz Insertion Loss: Low: 0.65dB(Max) High: 0.65dB(Max) VSWR*: 2.0dB (Max)	Low Band: 20dB(Min).@4800~5000MHz 20dB(Min).@7200~7500MHz High Band: 20dB(Min).@824~915 MHz 20dB(Min).@1800~2500 MHz 15dB(Min).@9800~11900 MHz	Size(mm): 2.0*1.25*0.5 Operating Temp.: -40~85°C RoHS Compliance
	DPX1608LL80R2455A 1608 2.4/5GHz Diplexer Type80	Freq. Range: 2400-2500MHz/ 4900-6000MHz Insertion Loss: Low: 0.7dB/ High: 0.8dB	Attenuation: Low Band: 20dB(Min).@4800~5000MHz 20dB(Min).@7200~7500MHz High Band:	Size(mm): 1.6*0.8*0.6 Operating Temp.: -40~85°C RoHS Compliance
	DPX1608LL85R2455A 1608 2.4/5GHz Diplexer Type85	VSWR*: Low: 2.0dB(Max)/ High: 1.7dB(Max)	Attenuation: Low Band: 28dB(Min).@860~960MHz 23dB(Min).@1545~1605MHz 23dB(Min).@1710~1990MHz High Band: 28dB(Min).@2170MHz 8dB(Min).@8100MHz 15dB(Min).@8820~9800MHz 27dB(Min).@9800~11800MHz	Size(mm): 1.6*0.8*0.6 Operating Temp.: -40~85°C RoHS Compliance
	DPX1608LL86R2455A 1608 2.4/5GHz Diplexer Type86	Freq. Range: 2400-2500MHz/ 4900-5950MHz Insertion Loss: Low: 0.6dB/ High: 1.2dB VSWR*: 2.0 (Max)	Attenuation: Low Band: 20dB(Min).@4800-5000MHz High Band: 28dB(Min).@30-2700MHz 10dB(Min).@9800-11900MHz 5dB(Min).@14700-17850MHz	Size(mm): 1.6*0.8*0.6 Operating Temp.: -40~85°C RoHS Compliance
	DPX1608LL82R2455A 1608 2.4/5GHz Diplexer Type82	Freq. Range: 2400~2500MHz/ 4900~6000MHz Insertion Loss: Low: 0.5dB(Max) High: 1.0dB(Max) VSWR*: 2.0dB (Max)	Attenuation Low Band: 25dB(Min).@4800~5000MHz 25dB(Min).@7200~7500MHz High Band: 32dB(Min).@300~2700MHz 15dB(Min).@9800~11900MHz 11dB(Min).@14700~17850MHz	Size(mm): 1.68*0.8*0.6 Operating Temp.: -40~85°C RoHS Compliance
	DPX1608LL83R2455A 1608 2.4/5GHz Diplexer Type83	Insertion Loss: 0.5dB Max @ 2400~2500MHz 1.5dB Max @ 4900~5950MHz VSWR*: 2.0(Max) Isolation: 35dB Max @ 2400~2500MHz 28dB Max @ 4900~5950MHz	Attenuation Low Band: 25dB(Min).@4800~5000MHz 25dB(Min).@7200~7500MHz High Band: 32dB(Min).@300~2700MHz 15dB(Min).@9800~11900MHz 11dB(Min).@14700~17850MHz	Size(mm): 1.68*0.8*0.6 Operating Temp.: -40~85°C RoHS Compliance

* VSWR depends on the environment





Wireless Components Selection Charts

Filter (Triplexer), Balun

Filter (Triplexer)

Model	Part No./ Description	Electrical Data	Mechanical Data	
	TPX2012LL90R1525A 2012 1.575/2.4/5GHz Triplexer Type90	Freq. Range: 1570-1610MHz/ 2400-2500MHz/4900-5950MHz Insertion Loss: Low: 0.8dB/ Mid.: 0.7dB/ High: 0.8dB VSWR*: Low: 2.0dB(Max)/ Mid.: 2.0dB(Max) High: 1.6dB(Max)	Attenuation: Low Band: 20dB(Min). @2400~2500MHz 20dB(Min). @4800~6000MHz Mid Band: 17.5dB(Min). @4800~5000MHz 10dB(Min). @1545~1605MHz 10dB(Min). @9600~10000MHz High Band: 27dB(Min). @860~960MHz 25dB(Min). @1545~1605MHz 25dB(Min). @1710~1990MHz 30dB(Min). @2170MHz 8dB(Min). @8100MHz 15dB(Min). @8820~9800MHz 27dB(Min). @9800~10760MHz 25dB(Min). @10760~11800MHz	Size(mm): 2.0*1.2*0.9 Operating Temp.: -40~85°C RoHS Compliance
	TPX2012LL95R1525A 2012 1.575/2.4/5GHz Triplexer Type95			

Balun

Model	Part No./ Description	Electrical Data	Mechanical Data	
	BLN0605LM09R0780A 0605 LSMH/EUDD Balun Type09, 5050	Freq. Range: 729~821MHz Insertion Loss: 0.6 dB (Max) VSWR*: 2.0dB (Max)	Unbalanced Impedance: 50Ω Balanced Impedance: 100Ω Phase Difference: 180 ± 10degree Amplitude Difference: ± 2 dB (Max)	Size(mm): 0.65*0.5*0.35 Operating Temp.: -40~85°C RoHS Compliance
	BLN0605LL19R1880A 0605 PCS/DCS RX Balun Type19, 5050	Freq. Range: 1805~1990MHz Insertion Loss: 0.6 dB (Max) VSWR*: 2.0dB (Max)	Unbalanced Impedance: 50Ω Balanced Impedance: 100Ω Phase Difference: 180 ± 10degree Amplitude Difference: ± 2 dB (Max)	Size(mm): 0.65*0.5*0.35 Operating Temp.: -40~85°C RoHS Compliance
	BLN1608LL01R2400A 1608 2.4G Balun Type01, 50100	Freq. Range: 2400-2500MHz Insertion Loss: 1.1 dB (Max) VSWR*: 2.0 (Max)	Unbalanced Impedance: 50Ω Balanced Impedance: 100Ω Phase Difference: 180 ± 10 degree Amplitude Difference: 2 dB (Max)	Size(mm): 1.6*0.8*0.65 Operating Temp.: -40~85°C RoHS Compliance
	BLN1608LL30R2400A 1608 2.4G Balun Type30, 5050	Freq. Range: 2400-2500MHz Insertion Loss: 1.2dB(Max) VSWR*: 2.0dB(Max)	Unbalanced Impedance: 50Ω Balanced Impedance: 50Ω Phase Difference: 180 ± 10 degree Amplitude Difference: 2 dB (Max)	Size(mm): 1.6*0.8*0.65 Operating Temp.: -40~85°C RoHS Compliance
	BLN1005LM39R2500A 1005 2.3-2.7GHz Balun Type39, 5050	Freq. Range: 2300~2690MHz Insertion Loss: 0.6 (Max) VSWR*: 2.0dB (Max)	Unbalanced Impedance: 50Ω Balanced Impedance: 100Ω Phase Difference: 180 ± 17 degree Amplitude Difference: ± 3.7 dB (Max)	Size(mm): 1.0*0.5*0.35 Operating Temp.: -40~85°C RoHS Compliance

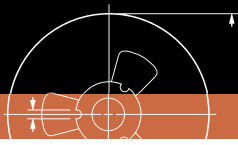

* VSWR depends on the environment



Wireless Components Selection Charts

Balun, Balance Filter (Combo), Coupler



Balun

Model	Part No./ Description	Electrical Data	Mechanical Data	
	BLN0605LL39R2500A 0605 2.3-2.7GHz Balun Type39, 5050	Freq. Range: 2300~2690MHz Insertion Loss: 0.6 dB (Max) VSWR*: 2.0dB (Max)	Unbalanced Impedance: 50Ω Balanced Impedance: 100Ω Phase Difference: 180 ± 10degree Amplitude Difference: ± 2 dB (Max)	Size(mm): 0.65*0.5*0.35 Operating Temp.: -40~85°C RoHS Compliance
	BLN1608LL01R5000A 1608 5G Balun Type01, 50100	Freq. Range: 4900-5950MHz Insertion Loss: 1.2 dB (Max) VSWR*: 2.0 (Max)	Unbalanced Impedance: 50Ω Balanced Impedance: 100Ω Phase Difference: 180 ± 10 degree Amplitude Difference: 1.5 dB (Max)	Size(mm): 1.6*0.8*0.65 Operating Temp.: -40~85°C RoHS Compliance

Balance Filter (Combo)

Model	Part No./ Description	Electrical Data	Mechanical Data	
	BLF2012LL98R2400A 2012 2.4G Combo Type98	Freq. Range: 2400-2500MHz Insertion Loss: 3.5dB (Max) VSWR*: 2.0 (Max) Unbalanced Impedance: 50Ω Balanced Impedance: Conjugate match to CSR BC03/04 series Phase Difference: 180 ± 5 degree @25°C Amplitude Balance: 1.0 dB (Max)	Attenuation: 40dB Min@880~960MHz 25dB Min@1300~1600MHz 35dB Min@4800~5000MHz 30dB Min@7200~7500MHz	Size(mm): 2.0*1.2*0.9 Operating Temp.: -40~85°C RoHS Compliance

Coupler

Model	Part No./ Description	Electrical Data	Mechanical Data	
	CPL1608LL09RWHEXA 1608 WWAN<E Coupler Type09	Freq. Range: 689.5-960.5MHz 1700-2100MHz/2300-2700MHz Insertion Loss: 0.25dB(Max)/ 0.3dB(Max)/ 0.4dB(Max) VSWR*: 1.4dB(Max)	Coupling: 23~28dB@689.5-960.5MHz 19.5~22.5dB@1700-2100MHz 19.5~24.5dB@2300-2700MHz	Size(mm): 1.6*0.8*0.7 Operating Temp.: -40~85°C RoHS Compliance
	CPL1608LL12RWHEXA 1608 WWAN<E Coupler Type12	Freq. Range: 689-960MHz 1710-2170MHz/2300-2690MHz Insertion Loss: 0.2dB(Max)/ 0.25dB(Max)/ 0.3dB(Max) VSWR*: 1.45dB(Max)	Coupling: 23~27dB@689-960MHz 21.5~26.5dB@1710-2170MHz 22.5~27.5dB@2300-2690MHz	Size(mm): 1.6*0.8*0.6 Operating Temp.: -40~85°C RoHS Compliance

* VSWR depends on the environment



Wireless Components Selection Charts

Product information - Ordering Information

Explanation of ordering code - New

Ordering example : ANT3216LL11R2400A

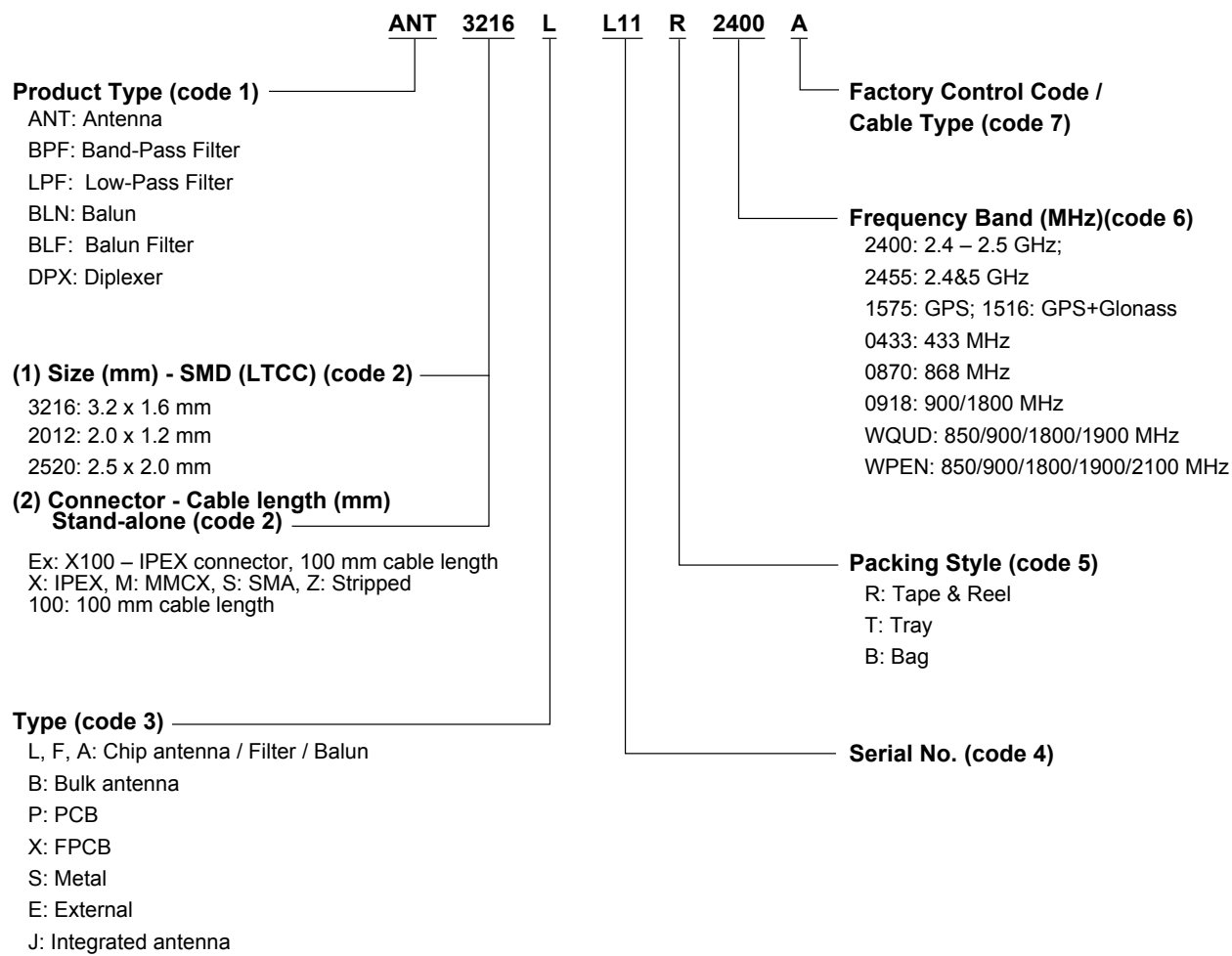

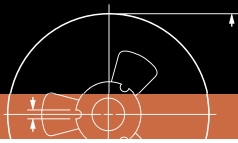

Wireless Components Sample Books

Sample Books

Wireless Sample Book: Ordering code ANT5B00000020190					
Product	Series	Dimension (mm)	PART NUMBER	Frequency Range (MHz)	
Antenna	2.4 GHz	8*1*1	ANT8010LL04R2400A	2400 - 2500	
		3.2*1.6*1.2	ANT3216LL11R2400A	2400 - 2500	
		3.2*1.6*1.2	ANT3216LL00R2400A	2400 - 2500	
		2*1.2*1	ANT2012LL13R2400A	2400 - 2500	
		1.6*0.8*0.4	ANT1608LL14R2400A	2400 - 2500	
		30*5*0.15	ANTX100F113B24003	2400 - 2500	
	2.4/5 GHz	5.3*2*1.1		ANT5320LL24R2455A	2400 - 2500 5150 - 5875
			3.2*1.6*1.2	ANT3216LL11R2455A	2400 - 2500 5150 - 5875
		1.6*0.8*0.4		ANT1608LL14R2455A	2400 - 2500 5150 - 5875
			40*6*0.15	ANTX100F112B24553	2400 - 2500 5150 - 5875
		GPS	8*1*1	ANT8010LL05R1575A	1575
			5.3*2*1.2	ANT5320LL14R1575A	1575
	3.2*1.6*1.2		ANT3216LL15R1575A	1575	
	12*12*4		ANT1212B00DT1575S	1575	
	15*15*4		ANT1515B00FT1575S	1575	
	18*18*2		ANT1818B00AT1575S	1575	
	GNSS	25*25*4	ANT2525B00FTGNSSS	1559 - 1610	
	GPS& GLONASS	5.3*2*1.2	ANT5320LL14R1516A	1575 / 1602	
		8*1*1	ANT8010LL05R1516A	1575 / 1602	
		18*18*4	ANT1818B00BT1516S	1575 / 1602	
		25*25*4	ANT2525B00DT1516S	1575 / 1602	
	GPS/2.4 GHz	5.3*2*1.2	ANT5320LL17R1524A	1575 / 2400	
	Cellular WWAN	21*12*0.9		ANT2112LL00B0918A	880 - 960 1710 - 1880
			12*4*1.2	ANT1204LL00R0918A	900 / 1800
		35*5*6		ANT3505B002TWPENS	824 - 960 1710 - 2170
			50*20*0.95	ANTX100P001BWPEN3	824 - 960 1710 - 2170
		40*5*6		ANT4005B000RWHXS	698 - 960 1710 - 2690
	Short-Range	24*0.5*1.6	ANT2405F001R0169A	169	
		12*4*1.6	ANT1204F002R0433A	315/433	
		12*4*1.5	ANT1204LL20R0433A	315/433	
		12*4*1.6	ANT1204LL08R0870A	870/915	
12*4*1.6		ANT1204F007R0870A	870/915		
SDARS		25*25*4	ANT2525B00FT2300S	2320 - 2345	
Filter	GPS/2.4/5 GHz	1.6*0.8*0.6	DPX1608LL87R1524A	1570-1610	
				2400 - 2500	
				4900-6000	
	2.4 GHz	2.0*1.25*0.9	1.6*0.8*0.6	BLF2012LL98R2400A	2400 - 2500
				BLN1608LL30R2400A	2400 - 2500
				BPF1608LM02R2400A	2400 - 2500
				LPF1005LL50R2400A	2400 - 2500
				LPF1608LL53R2400A	2400 - 2500
	2.4/5 GHz	1.6*0.8*0.6		DPX1608LL80R2455A	2400 - 2500
				DPX1608LL85R2455A	4900-6000
		2.0*1.25*0.5			2400 - 2500
				DPX2012LL75R2455A	4900-5950



YAGEO - A GLOBAL COMPANY

ASIA

HQ

Taipei, Taiwan

Tel. +886 2 6629 9999

Fax. +886 2 6628 8886

Suzhou, China

Tel. +86 512 6825 5568

Fax. +86 512 6825 5386

Shanghai, China

Tel. +86 21 64858697

Dongguan, China

Tel. +86 769 8772 0275

Fax. +86 769 8791 0053

Kuala Lumpur, Malaysia

Tel. +60 3 8063 8864

Fax. +60 3 8063 7376

Penang, Malaysia

Tel. +60 4 3973049

Fax. +60 4 3973050

Tokyo, Japan

Tel. +81 3 6809 3972

Fax. +81 3 6809 3982

Seongnam, Korea

Tel. +82 31 712 4797

Fax. +82 31 712 5866

Singapore

Tel. +65 6244 7800

Fax. +65 6244 4943

EUROPE

Munich, Germany

Tel. +49 8990 7784 380

Fax. +49 8990 7784 379

Milan, Italy

Tel. +39 02 6129 1017

Fax. +39 02 6601 7490

Szombathely, Hungary

Tel. +36 94 517 702

Fax. +36 94 517 701

Roermond, Benelux

Tel. +31 475 575 090

Fax. +31 475 575 090

NORTH AMERICA

San Jose, U.S.A.

Tel. +1 408 240 6200

Fax. +1 408 240 6201

Mexico

Tel. +52 33 31330631

Fax. +1 408 240 6201

For a complete listing of all Yageo sales offices, distributors, and representatives, please visit "contact us" at

www.yageo.com

© YAGEO Corporation

All rights are reserved. Reproduction in whole or in part is prohibited without the prior written consent of the copyright owner.

The information presented in this document does not form part of any quotation or contract, is believed to be accurate and reliable and may be changed without notice.

No liability will be accepted by the publisher for any consequence of its use. Publication thereof does not convey nor imply any license under patent or other industrial or intellectual property rights.